

*"Producing High Quality Surgical,
Dental & ENT Instruments for 25 Years"*

gmed-instruments.com



For over 25 years Glomed Instruments have provided quality Instruments across the world to help improve the standard of patient care. The Glomed Instruments brand is especially known globally in the Surgical, Dental and ENT fields.

We are one of the oldest surgical instrument manufacturers in the world today, and have continued our legacy in providing high quality, hand-crafted instrumentation.

Over the years, the Glomed Instruments brand has maintained high standards of quality and continues to emphasize customer service and satisfaction. As surgical procedural needs change, specialty surgeons can count on Glomed Instruments instruments to meet their new requirements.

Glomed Instruments offers the most extensive line of Surgical and Dental instruments with more than 1,000 patterns. Glomed Instruments instruments, conforms to the highest standards of precision and reliability, consistency of pattern and lasting value.

gmed-instruments.com



"We cater to everything that concerns your life. That is why for over 25 years, we have been working to make this world better by manufacturing and distributing instruments that can improve the field of dentistry and surgery"

CERTIFICATIONS

- ISO 7376 : 2009
- ISO 10993-5 BIO COMPATIBILITY / CYTOTOXICITY STANDARD



GLOMED INSTRUMENTS

Grosvenor Business Tower, 1503, TECOM, Dubai, UAE.
PO Box 283024, T: +971 4 435 7344, F: +971 4 435 7345

gmed-instruments.com

SET FOR EXTRACTION AND ORAL SURGERY	01
EXTRACTING FORCEPS	02 - 29
ROOT SPLINTER FORCEPS	30
BONE RONGEURS	31 - 32
ROOT ELEVATORS KIT	33
ROOT ELEVATORS	34 - 46
ROOT - TIP PICKS	47
SYNDESMOTOMES & INSTRUMENTS KIT	48-50
PRESENTATION	51
INSTRUMENTS KIT FOR ORAL SURGERY	52
GUM SCISSORS	53-56
SURGICAL SCISSORS	57-58
SCALPEL HANDLES - SCALPEL BLADES	59
NEEDLE HOLDERS	60 -63
INTRA-LIGAMENTAL SYRINGES	64
DENTAL SYRINGES	65
HAEMOSTATIC FORCEPS	66 - 68
TOWEL CLAMPS	69
DRESSING FORCEPS	70
MOUTH GAGS - TONGUE FORCEPS	71
RETRACTORS - TONGUE DEPRESSORS	72
RETRACTORS	73 - 76
TISSUE PLIERS	77 - 80
SURGICAL SALIVA EJECTORS	81
IMPLANT SURGERY	82 -92
COTTON AND DRESSING PLIERS	93 -94
EXPLORERS ANATOMIC HANDLE	95-103
ENDODONTIC INSTRUMENTS	104-107
ULTRALIGHT MIRROR AND RETRACTOR	108
RUBBER DAM CLAMPS	109-112
AMALGAM CARRIERS	113-114
CEMENT SPATULAS	115
HEIDEMANN SEPARATING SPATULAS	116
FILLING INSTRUMENTS	117 -124
AMALGAM CARVES	125
CAVITY PREPARATION INSTRUMENTS	126
EXCAVATORS	127 -132
CROWN INSTRUMENTS	133-136
MATRIX RETAINERS	137
MATRIX BANDS	138
PERIODONRAL INSTRUMENTS	139-140
BONE FILES	141-142
PERIODONTAL INSTRUMENTS	143-146
GRACEY CURRETTES AF TYPE	147
GRACEY CURRETTES MF TYPE	148
PERIODONTAL INSTRUMENTS	149 - 152
SCALERS	153-154
INSTRUMENT TRAYS	155
ALUMINIUM INSTRUMENT TRAYS	156
STAINLESS STEEL IMPRESSION TRAYS	157-162
ARTICULATORS	163-168
WAX AND MODELLING CARVERS	169-170
LABORATORY TWEEZERS	171
WAX KNIVES	172
PLASTER KNIVES	173
SPATULAS FOR PLASTER ALGINATE & ELASTOMERS	174 -175
LABORATORY INSTRUMENTS	176 - 177
SAW AND BLADES	178
UNIVERSAL PILERS	179
ORTHODONTIC PLIERS	180 - 189
PLIERS TRAY	190

INSTRUMENTS SET FOR EXTRACTION AND ORAL SURGERY



Set - 1001

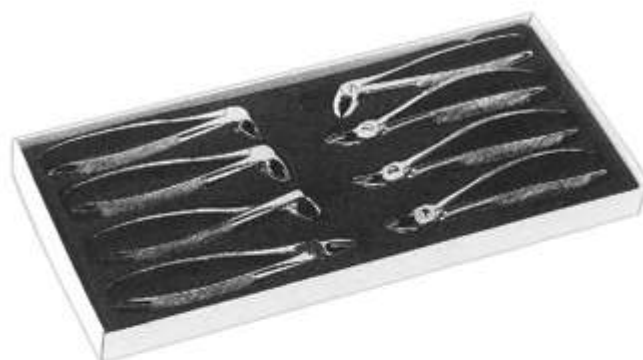

Set - 1002



Set - 1003



Set - 1004



With
Serrated
Tips

1005 Fig. 1
Upper Incisors and Canines

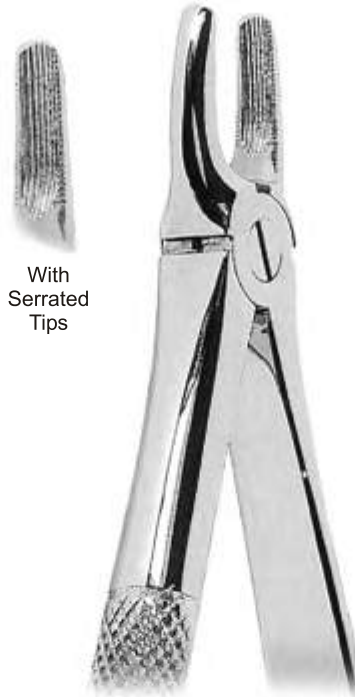

With
Serrated
Tips

1006 Fig. 2
Upper Incisors and Canines

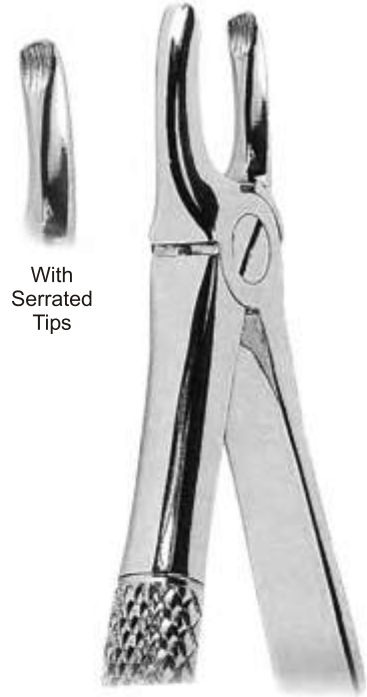

With
Serrated
Tips

1007 Fig. 3
Overlapping Upper
Incisors and Canines



With
Serrated
Tips

1008 Fig. 4
Lower Incisors and Canines



With
Serrated
Tips

1009 Fig. 7
Upper Premolars

EXTRACTING FORCEPS



With Serrated Tips

1010 Fig. 8
Lower Premolars



With Serrated Tips

1011 Fig. 13
Lower Premolars



With Serrated Tips

1012 Fig. 18A
Upper Molars



With Serrated Tips

1013 Fig. 17
Upper Molars, Right



With Serrated Tips

1014 Fig. 18
Upper Molars, Left



With Serrated Tips

1015 Fig. 20
Lower third molars



With Serrated Tips

1016 Fig. 21
Lower molars



With Serrated
Tips

1017 Fig. 19
Upper Third Molars



With Serrated
Tips

1018 Fig. 22L
Lower Molars and Third Molars, Left



With Serrated
Tips

1020 Fig. 22R
Lower Molars and Third Molars, Right



1019 Fig. 22
Lower Molars

EXTRACTING FORCEPS



With
Serrated
Tips

1021 Fig. 23
Lower Molars, Right



With
Serrated
Tips

1022 Fig. 24
Lower Molars, Left



With
Serrated
Tips



1023 Fig. 29
Upper Roots



With
Serrated
Tips



1024 Fig. 29N
Upper Roots and Incisors



With
Serrated
Tips



1025 Fig. 30
Upper Roots



With
Serrated
Tips



1026 Fig. 31
Lower Roots and Incisors



With
Serrated
Tips

1027 Fig. 33
Lower Roots



With
Serrated
Tips

1028 Fig. 33A
Lower Roots



With
Serrated
Tips

1029 Fig. 33L
Lower Roots



With
Serrated
Tips

1030 Fig. 38A
Fractured or Decayed Lower Teeth

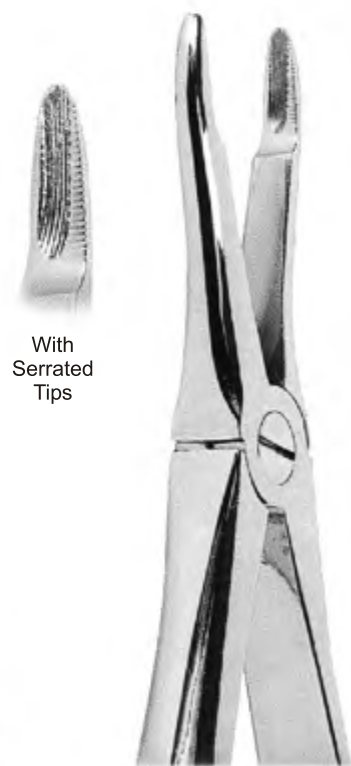

With
Serrated
Tips

1031 Fig. 41
Upper Roots

EXTRACTING FORCEPS



With Serrated Tips

1032 Fig. 43A
Fractured or Decayed Upper Teeth



With Serrated Tips

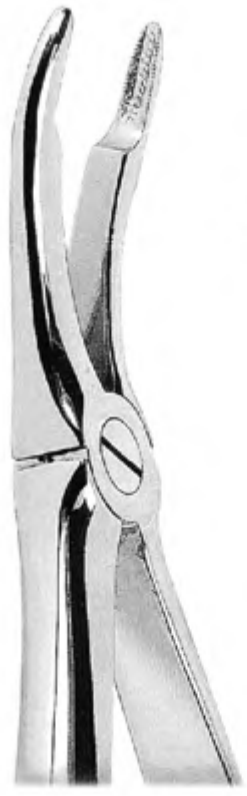

1033 Fig. 44
Upper Roots



With Serrated Tips



1034 Fig. 45
Lower Roots



With Serrated Tips

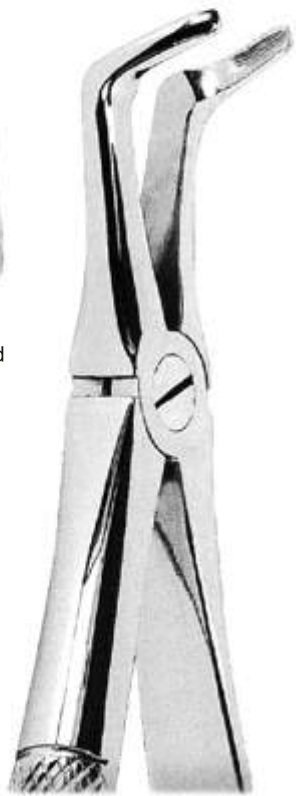

1035 Fig. 46
Lower Roots



With Serrated Tips

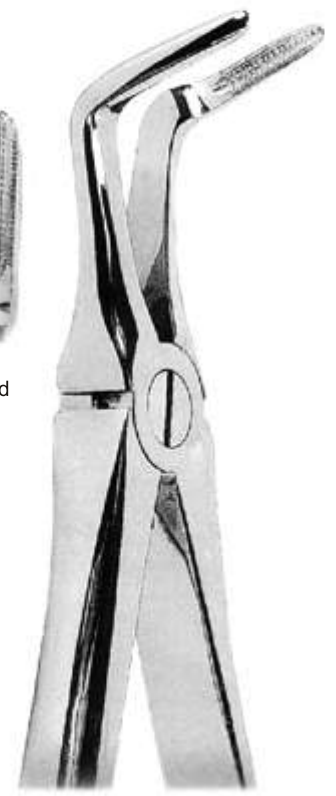

1036 Fig. 46L
Lower Roots



With
Serrated
Tips

1037 Fig. 48
Upper Roots



With
Serrated
Tips



1038 Fig. 49
Upper Roots



With
Serrated
Tips



1039 Fig. 51
Upper Roots



With
Serrated
Tips

1040 Fig. 51A
Upper Roots



With
Serrated
Tips

1041 Fig. 51L
Upper Roots

EXTRACTING FORCEPS



With
Serrated
Tips

1042 Fig. 51LX
Upper Roots



With
Serrated
Tips

1043 Fig. 52
Upper Roots and Canines

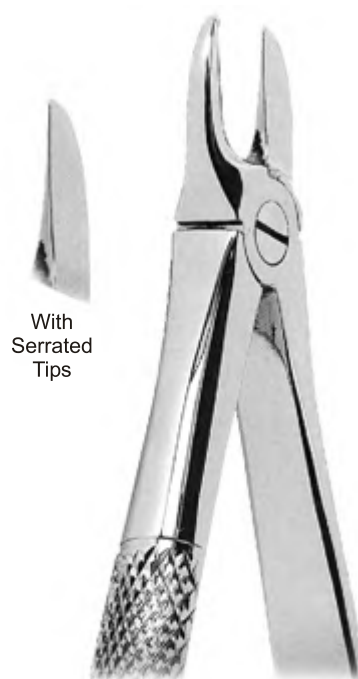

With
Serrated
Tips

1044 Fig. 54
For Separating Upper Molars

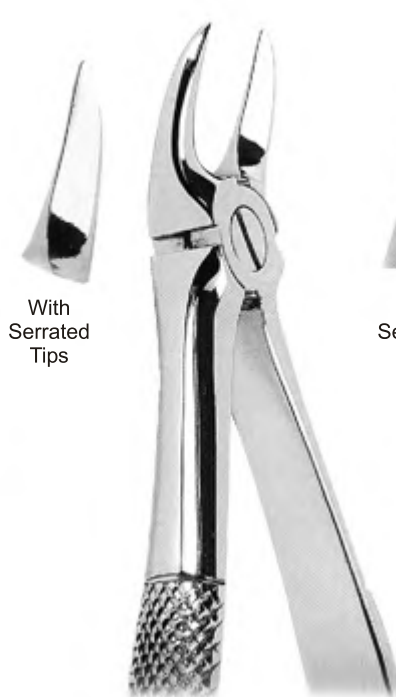

With
Serrated
Tips

1045 Fig. 55
For Separating Upper Molars



With
Serrated
Tips

1046 Fig. 56
For Separating Lower Molars



1047 Fig. 59
Lower Roots



1048 Fig. 59L
Lower Incisor Roots



1049 Fig. 60
Lower Roots



1050 Fig. 65L
Upper Molars, Left



1051 Fig. 65R
Upper Molars, Right

EXTRACTING FORCEPS



With Serrated Tips

1052 Fig. 66L
Upper Molars, Left



With Serrated Tips

1053 Fig. 66R
Upper Molars, Right



With Serrated Tips

1054 Fig. 67
Upper third Molars



With Serrated Tips

1055 Fig. 67A
Upper Third Molars



With Serrated Tips

1056 Fig.68
Lower Roots



With
Serrated
Tips

1057 Fig. 67 1/2 L
Upper Third Molars, Left



With
Serrated
Tips

1058 Fig. 671/2R
Upper Third Molars, Right



With
Serrated
Tips

1059 Fig. 73
Lower Molars



With
Serrated
Tips

1060 Fig. 74
Lower Roots



With
Serrated
Tips

1061 Fig. 74M
Lower Roots

EXTRACTING FORCEPS



With
Serrated
Tips

1062 Fig. 74N
Lower Roots



With
Serrated
Tips

1063 Fig. 75
Lower Canines and Premolars



With
Serrated
Tips

1064 Fig. 79
Lower Third Molars



With
Serrated
Tips

1065 Fig. 79A
Lower Third Molars



With
Serrated
Tips

1066 Fig. 79C
Lower Third Molars



1067 Fig. 86 1/2L
Lower Third Molars, Left

1068 Fig. 86 1/2 R
Lower Third Molars, Right

1069 Fig. 86C
Lower Molars

1070 Fig. 86W White - cm. 17
Extracting Forceps for Lower Last Molar

EXTRACTING FORCEPS



1071 Fig. 87
Lower Decayed Molars or Broken Crowns



With
Serrated
Tips



1072 Fig. 89
Upper Molars, Right



With
Serrated
Tips



1073 Fig. 90
Upper Molars, Left



With
Serrated
Tips



1074 Fig. 99
Lower Molars With Broken Crowns



With
Serrated
Tips

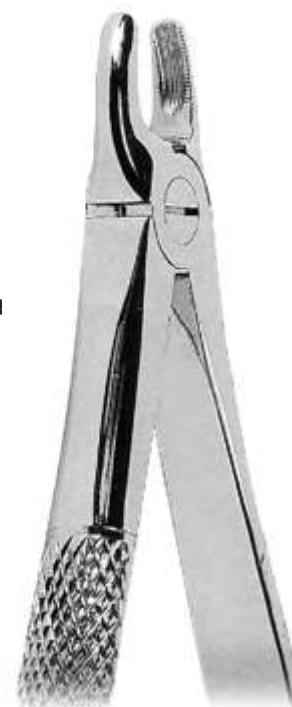

1075 Fig. 107
Upper Canines



With
Serrated
Tips

1076 Fig. 121
Upper Third Molars



With
Serrated
Tips

1077 Fig. 145
Lower Roots

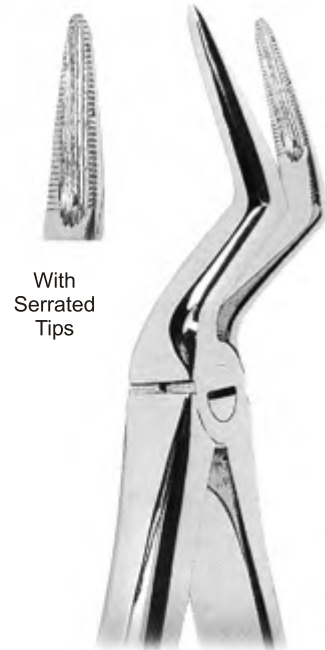

With
Serrated
Tips

1078 Fig. 151 1/2
Upper Roots



1079 Fig. 166
Universal extracting forceps
for upper teeth,
in particular molars and premolars



1080 Fig. 167 Trotter
Universal extracting forceps
for lower teeth
in particular molars and premolars

EXTRACTING FORCEPS



With
Serrated
Tips

1081 Fig. 168
Upper Canines



With
Serrated
Tips

1082 Fig. 169
Lower Canines

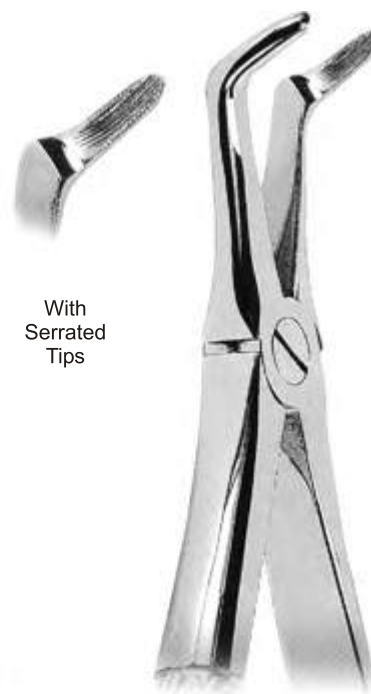

With
Serrated
Tips

1083 Fig. 346
Lower Roots

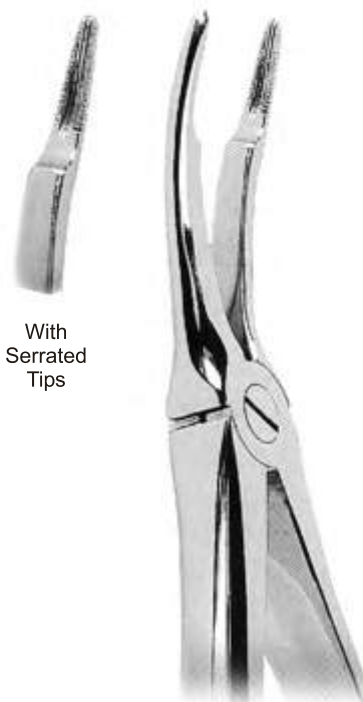

With
Serrated
Tips

1084 Fig. 349
Upper Roots



With
Serrated
Tips

1085 Fig. 359
Lower Roots



With
Serrated
Tips

1086 Fig. 1
Universal extracting forceps
for upper incisors and canines

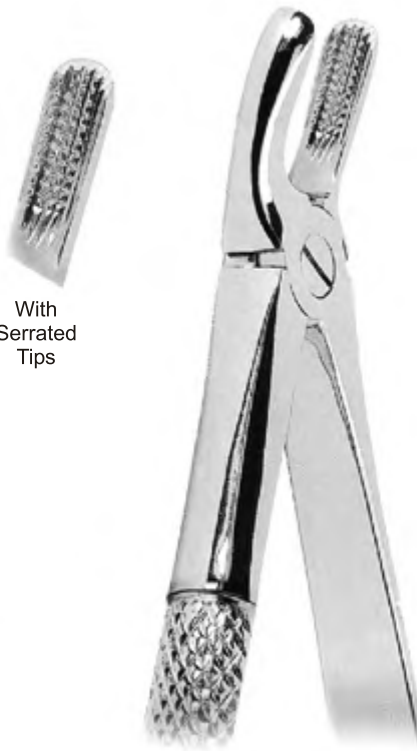

With
Serrated
Tips

1087 Fig. 2
Upper Molars



With
Serrated
Tips

1088 Fig. 3
Lower Incisors, Premolars and Roots



With
Serrated
Tips

1089 Fig. 4
Lower Molars

EXTRACTING FORCEPS WITH ANATOMICALLY SHAPED HANDLE



With Serrated Tips

1090 Fig. 1
Upper incisors and canines



With Serrated Tips



1091 Fig. 2
Upper incisors and canines



With Serrated Tips



1092 Fig. 4
Lower incisors and canines



With Serrated Tips

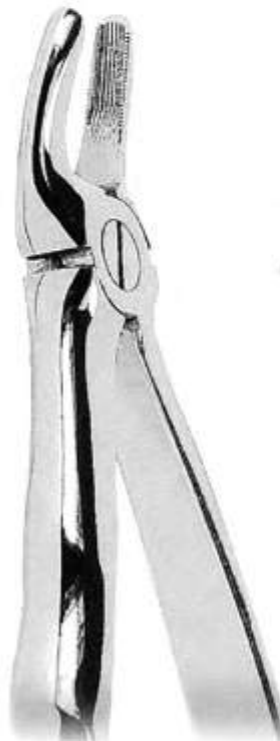

1093 Fig. 7
Upper premolars



With Serrated Tips



1094 Fig. 13
Lower premolars



With
Serrated
Tips

1095 Fig. 17
Upper molars, right

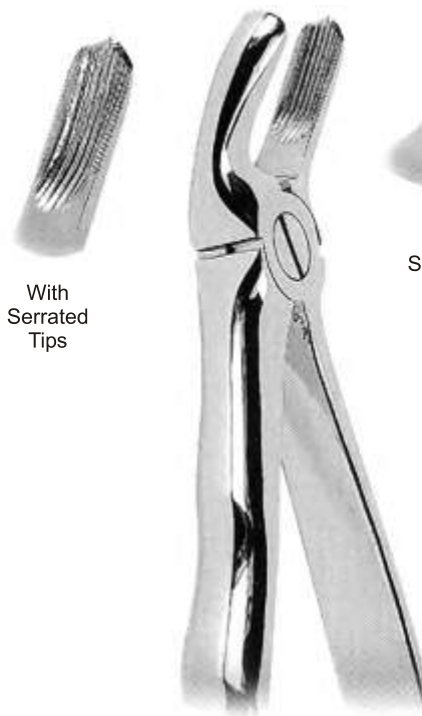

With
Serrated
Tips

1096 Fig. 18
Upper molars, left

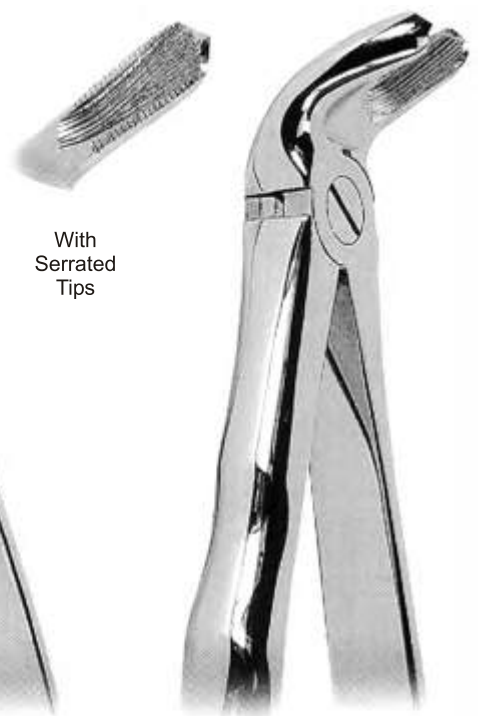

With
Serrated
Tips

1097 Fig. 21
Lower molars



With
Serrated
Tips

1098 Fig. 22
Lower molars

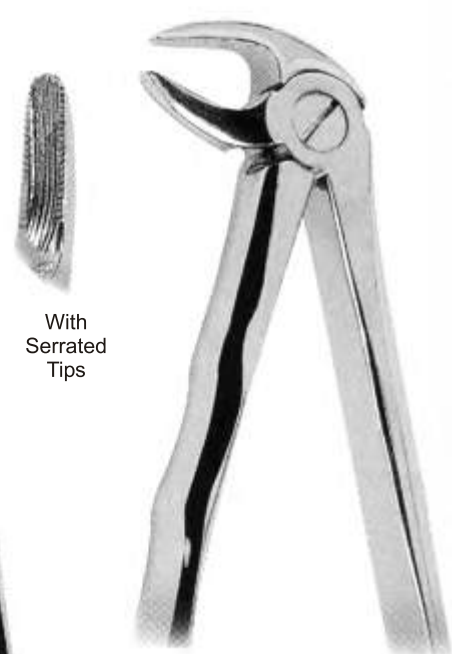

With
Serrated
Tips

1099 Fig. 33
Lower roots

EXTRACTING FORCEPS WITH ANATOMICALLY SHAPED HANDLE



With
Serrated
Tips

1100 Fig. 45
Lower roots



With
Serrated
Tips



1101 Fig. 51A
Upper roots



With
Serrated
Tips



1102 Fig. 67A
Upper third molars



With
Serrated
Tips



1103 Fig. 74
Lower roots



With
Serrated
Tips



1104 Fig. 79
Lower third molars



With
Serrated
Tips



1105 Fig. 86C
Lower molars



With
Serrated
Tips



1106 Fig. 359
Lower roots



With
Serrated
Tips

1107 Fig. 89
Upper molars, right



With
Serrated
Tips



1108 Fig. 90
Upper molars, left



With
Serrated
Tips

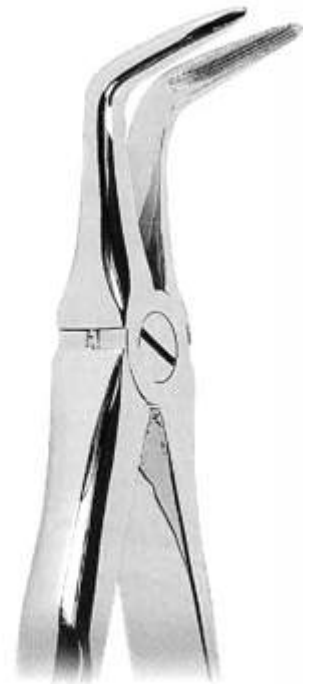

1109 Fig. 145
Lower roots



1110 Fig. 151 1/2
Upper roots



1111 Fig. 349
Upper roots

EXTRACTING FORCEPS AMERICAN PATTERN



1112 Fig. 5
Lower third molars



1113 Fig. 6
Separating forceps



1114 Fig. 10S
Upper molars



1115 Fig. 16i
Lower molars



1116 Fig. 17
Lower molars





1122 Fig. 65
Upper incisors and roots



1123 Fig. 69 Tomes
Upper and lower roots



1124 Fig. 88R Nevius
Upper molars, right



1125 Fig. 88L Nevius
Upper molars, left



1126 Fig. 101 Hull
Deciduous teeth



1127 Fig. 150 Cryer
Upper incisors, premolars, roots



1128 Fig. 150S Cryer
Upper teeth (for children)



1129 Fig. 151 Cryer
Lower incisors, premolars, roots



1130 Fig. 151S Cryer
Lower teeth (for children)



1131 Fig. 222
Lower third molars

EXTRACTING FORCEPS FOR CHILDREN

Set - 1132

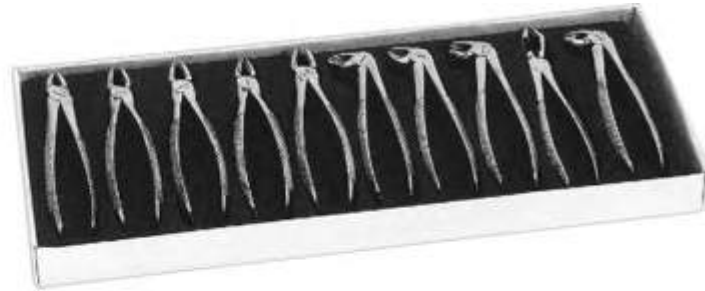

With
Serrated
Tips

1133 Fig. 37
Upper incisors



With
Serrated
Tips

1134 Fig. 39
Upper molars



With
Serrated
Tips

1135 Fig. 39R
Upper molars, right



With
Serrated
Tips

1136 Fig. 39L
Upper molars left



With
Serrated
Tips

1137 Fig. 51S
Upper roots



1138 Fig. 65
Upper incisors and roots



1139 Fig. 69 Tomes
Upper and lower roots



1140 Fig. 88R Nevius
Upper molars, right



1141 Fig. 88L Nevius
Upper molars, left



1142 Fig. 101 Hull
Deciduous teeth

EXTRACTING FORCEPS FOR CHILDREN - KLEIN PATTERN

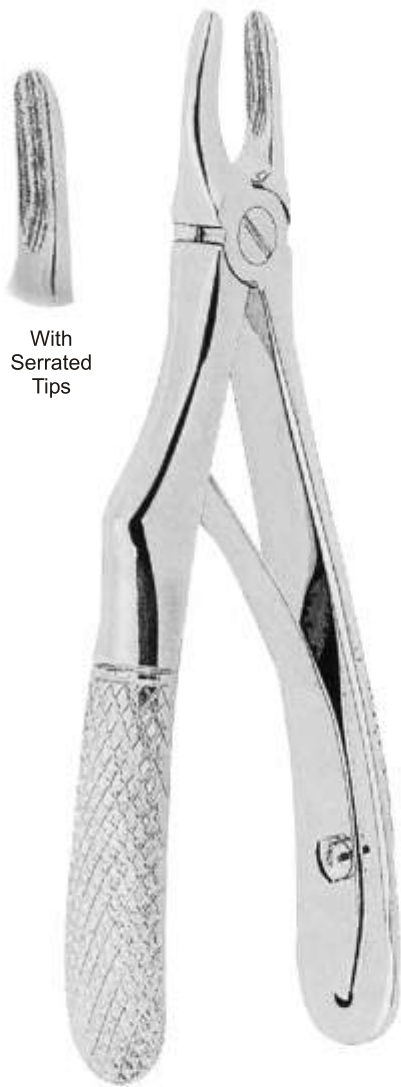

With Serrated Tips

1143 Fig. 1
Upper incisors



With Serrated Tips



1144 Fig. 2
Upper premolars



With Serrated Tips



1145 Fig. 3
Upper molars



With Serrated Tips



1146 Fig. 4
Upper roots



With Serrated Tips



1147 Fig. 5
Lower incisors



Set -1150



1148 Fig. 6
Lower molars



1149 Fig. 7
Lower roots



With
Serrated
Tips

1051 Fig. 1 Witzel
Lower Roots



With
Serrated
Tips

1052 Fig. 2 Witzel
Upper Roots



1053 Fig. 1 Stieglitz
Root Fraaments



1054 Fig. 2 Stieglitz
Root Fraaments

BONE RONGEURS



1155
Luer
cm.15



1156
Friedman
cm.14



1157
Mini Friedman
cm.12



1158
Goldman-Fox
cm. 10



1159
Blumenthal
cm. 12



1160
Blumenthal 45°
cm. 14.5



1161
Blumenthal 90°
cm. 14



1162
Mead 1A
cm. 16.5



1163
Cleveland 5
cm. 16.5



1164
Cleveland-Gardner
cm. 16.5

BONE RONGEURS, MULTIPLE ACTION



1165
Mini-Ruskin
cm. 15.5



1166
Beyer
cm. 18

ROOT ELEVATORS KIT



Set- 1167



Set- 1168



Set- 1169

With Stainless Steel Handle

4mm



1170
Fig. 1
Hylin

3.6 mm



1171
Fig. 2
Hylin

3.6 mm



1172
Fig. 3
Hylin



1173
Fig. 4
Hylin



1174
Fig. 1
Coleman



1175
Fig. 2



1176
Fig. 3

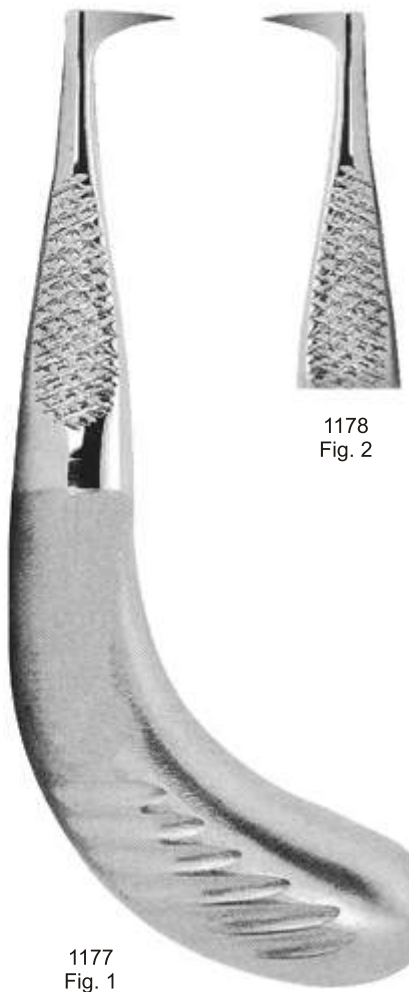

1177
Fig. 1



1178
Fig. 2

ROOT ELEVATORS

With Stainless Steel Handle



3 mm

4 mm

3 mm

4 mm

3,2 mm

3,8 mm



1179
Fig. 1B
Bein



1180
Fig. 2B
Bein



1181
Fig. 3B
Bein



1182
Fig. 4B
Bein



1183
Fig. 5B
Bein



1184
Fig. 6B
Bein

3 mm

3.5 mm



1185
Fig. 1F
Flohr



1186
Fig. 2F
Flohr



1187
Fig. 3F
Flohr



1188
Fig. 4B SA
Schmecke-
bier
Apexo



1189
Fig. 5B SA
Schmecke-
bier
Apexo



1190
Fig. 4 SA
Schmecke-
bier
Apexo



1191
Fig. 5 SA
Schmecke-
bier
Apexo

Concave tip

Flat tip

With Stainless Steel Handle

3,6 mm



1192
Fig. 1K
Kopp

3,6 mm



1193
Fig. 2K
Kopp

4,2 mm



1194
Fig. 3K
Kopp

4,2 mm



1195
Fig. 4K
Kopp

3,8 mm



1196
Fig. 5K
Kopp

1197
Fig. 6K
Kopp

2,5 mm



1198
Fig. 1

HELICOIDAL TIPS



1199
Fig. 2



1200
Fig. 3



1201
Fig. 4



1202
Fig. 1



1203
Fig. 2

ROOT ELEVATORS

With Stainless Steel Handle



1204
Fig. 71
Miller-Apexo



1205
Fig. 72
Miller-Apexo



1206
Fig. 73
Miller-Apexo



1207
Fig. 74
Miller-Apexo



1208
Fig. 19



1209
Fig. 20



1210
Fig. 34S
Seldin



1211
Fig. 34
Seldin



1212
Fig. 2S
Seldin



1213
Fig. 3S
Seldin

With Stainless Steel Handle



1214
Fig. 1L
Seldin



1215
Fig. 1R
Seldin



1216
Fig. 4L
Seldin



1217
Fig. 4R
Seldin



1218
Fig. 51
Curtis



1219
Fig. 52
Curtis



1220
Fig. 11
Stout



1221
Fig. 11a
Stout



1222
Fig. 12

ROOT ELEVATORS

With Stainless Steel Handle



Flat Tip

1223
Fig. A
Cogswell



1224
Fig. 301
Apexo



1225
Fig. 302
Apexo



1226
Fig. 303
Apexo



1227
Fig. 301W
Seldin



1228
Fig. 304W
Seldin



1229
Fig. 1H
Heidbrink



1230
Fig. 2H
Heidbrink



1231
Fig. 40H
Heidbrink



1232
Fig. 41H
Heidbrink

With Stainless Steel Handle



1233
Fig. 44
Cryer



1234
Fig. 45
Cryer



1235
Fig. 25
Cryer



1236
Fig. 26
Cryer



1237
Fig. 31
Cryer



1238
Fig. 32
Cryer



1239
Fig. 81A



1240
Fig. A1C
Coupland



1241
Fig. A2C
Coupland



1242
Fig. A3C
Coupland

ROOT ELEVATORS

With Stainless Steel Handle



1243
Fig. 190



1244
Fig.191



1245
Fig. 15
Woodward



1246
Fig. 16
Woodward



1247
Fig. 1C
Coupland



1248
Fig. 2C
Coupland



1249
Fig. 3C
Coupland



1250
Fig. 11M
Mac Millan



1251
Fig. 12M
Mac Millan



1252
Fig. 13M
Mac Millan



1253
Fig. 31F
Friedman



1254
Fig. 32F
Friedman

With Stainless Steel Handle



3.2 mm

1255
Fig. 1



2 mm

1261
Fig.1
Bein



4 mm

1256
Fig. 2



3.5 mm

1257
Fig. 2
Flohr



1258
Fig. 3
Flohr



1259
Fig. 7
Cryer



1260
Fig. 8
Cryer



3 mm

1262
Fig. 2
Bein



3.7 mm

1263
Fig. 3
Bein



3 mm

1264
Fig. 4
Bein



3.7 mm

1265
Fig. 5
Bein



4.3 mm

1266
Fig. 6
Bein

ROOT ELEVATORS WITH ANATOMICALLY SHAPED HANDLE

With Stainless Steel Handle



1267
Fig. 1B
Bein

3 mm

4 mm

3 mm

4 mm

3.2 mm

3.8 mm



1268
Fig. 2B
Bein



1269
Fig. 3B
Bein



1270
Fig. 4B
Bein



1271
Fig. 5B
Bein



1272
Fig. 6B
Bein



1273
Fig. 1F
Flohr



1274
Fig. 2F
Flohr



1275
Fig. 3F
Flohr



1276
Fig. 4 SA
Schmeckeber
Apexo



1277
Fig. 5 SA
Schmeckeber
Apexo

ROOT ELEVATORS WITH ANATOMICALLY SHAPED HANDLE

With Stainless Steel Handle



1278
Fig. 71
Miller-Apexo



1279
Fig. 72
Miller-Apexo



1280
Fig. 4L
Seldin



1281
Fig. 4R
Seldin



1282
Fig. 1H
Heidbrink



1283
Fig. 2H
Heidbrink



1284
Fig. 41H
Heidbrink



1285
Fig. 301
Apexo



1286
Fig. 301W
Seldin



1287
Fig. 25
Cryer



1288
Fig. 26
Cryer



1289
Fig. 44
Cryer



1290
Fig. 45
Cryer

ROOT ELEVATORS

With Stainless Steel Handle



Walter F. Barry



1291
Fig. 320
Walter F. Barry



1292
Fig. 321
Walter F. Barry



1293
Fig. 322
Walter F. Barry



1294
Fig. 323
Walter F. Barry



1295
Fig. 350
Walter F. Barry



1296
Fig. 351
Walter F. Barry



1297
Fig. 370
Walter F. Barry



1298
Fig. 371
Walter F. Barry



Lecluse



1299
Fig. 1LC
Lecluse

With Stainless Steel Handle



Winter



1300
Fig. 1LW
Winter



1301
Fig. 1RW
Winter



1302
Fig. 11Lw



1303
Fig. 11RW
Winter



1304
Fig. 24
Pott



1305
Fig. 25
Pott



1306
Fig. 12LW
Winter



1307
Fig. 12RW
Winter



1308
FIG. 14LW
Winter



1309
Fig. 14RW
Winter

ROOT - TIP PICKS

With Stainless Steel Handle



1310
Fig. 1
Heidbrink



13011
Fig. 2
Heidbrink



13012
Fig. 3
Heidbrink



1313
Fig. 1
Warwick-james



1314
Fig. 2
Warwick-james



1315
Fig. 3
Warwick-james



1316
Fig. 1
Heidbrink



1317
Fig. 2
Heidbrink



1318
Fig. 3
Heidbrink



1319
Cm. 11



1320
Fig. 0



1321
Fig. 1

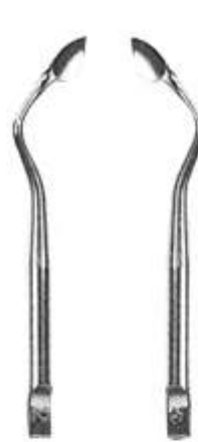

1322
Fig. 2



1323
Fig. 3



1324
Fig. 4



1325
Fig. 5

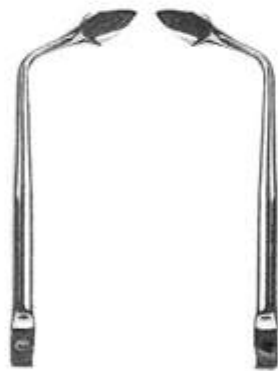

1326
Fig. 6



1327
Fig. 7



1328
Fig. 8



1329
Fig. 9



1330
Fig. 11



1332
Fig. 22



1333
Fig. 23



1334
Fig. 24



1335
Fig. 25



1336
Fig. 26



1337
Fig. 27



1338
Fig. 28



1339
Fig. 29

SYNDESMOTOMES INSTRUMENTS KIT

Set - 1340

Complete kit composed of 1 handle and 20 interchangeable tips, with complete tray



Set - 1341

Complete kit composed of 1 handle and 11 interchangeable tips, with complete tray



Syndesmotome tips holder, 20 holes



Set - 1342
mm.70x40x12



With stainless steel handle

Periotomes

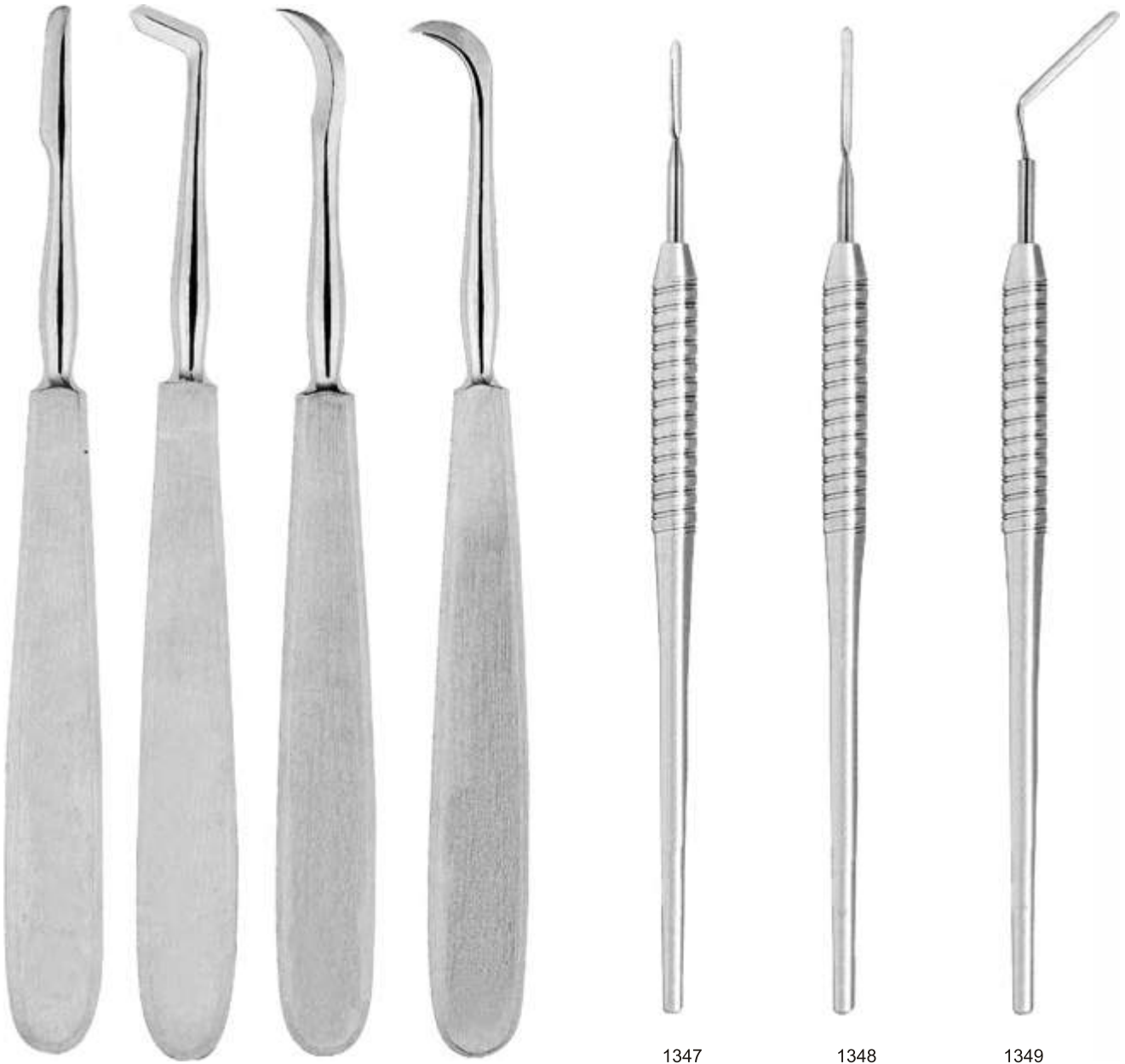

1343
Fig. 1
Chompret

1344
Fig. 2
Chompret

1345
Fig. 3
Chompret

1346
Fig. 4
Chompret

1347
Fig. 1

1348
Fig. 2

1349
Fig. 3

Set - 1350

Empty case for 12 extracting forceps and 26 instruments



Set - 1351

Case for instruments and pliers, with 39 instruments

Set - 1352
Empty case for 35 instruments



Set - 1353

Case for instruments, with 35 instruments, for oral surgery

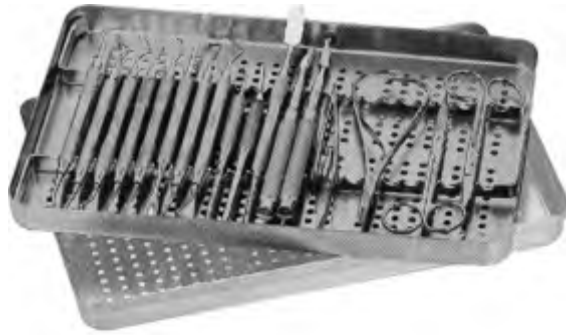

1354



1355



1356

GUM SCISSORS



1357
Fig. 1
cm. 12



Straight



Curved
1358
Fig.2

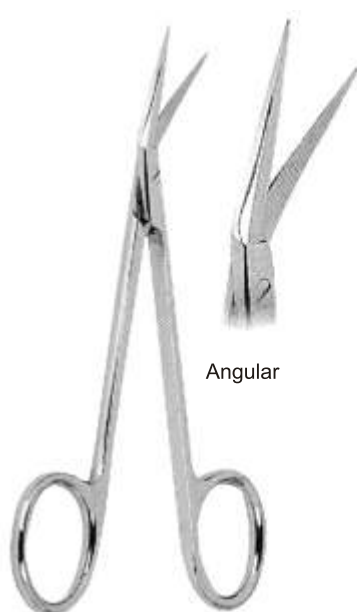

1359
Fig.1
cm. 11.5



Angular



Angolari, one
blade serrated

1360
Fig. 2



1361
Fig.1
Iris
cm.11.5



Straight



1362
Fig.2
Iris



Curved



1363
Fig.3
Iris



Straight, one blade serrated

1364
Fig.1
Goldman-Fox
cm. 13

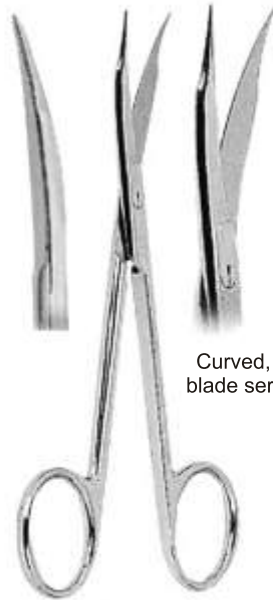

Curved, one blade serrated

1365
Fig.2
Goldman-Fox
cm. 13

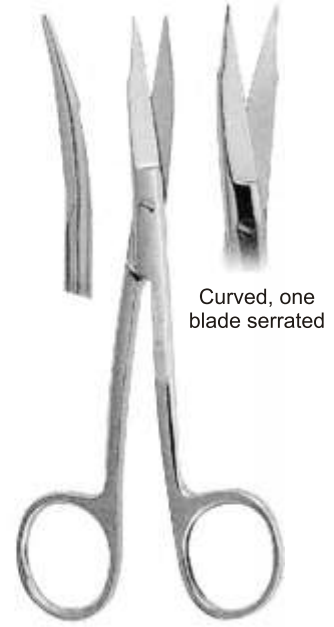

Curved, one blade serrated

1366
Fig.3
Goldman-Fox (special)
cm. 13

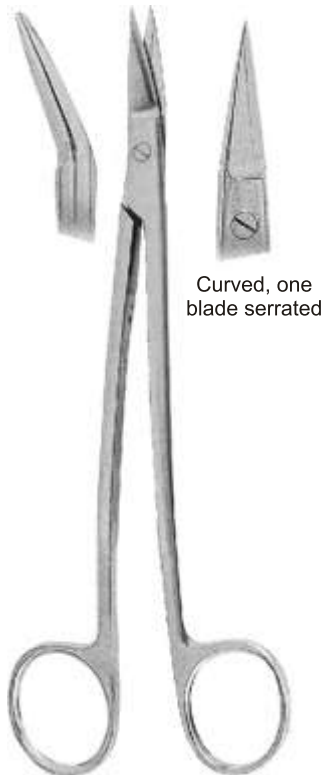

Curved, one blade serrated

1367
Fig. 1
Dean
cm. 17

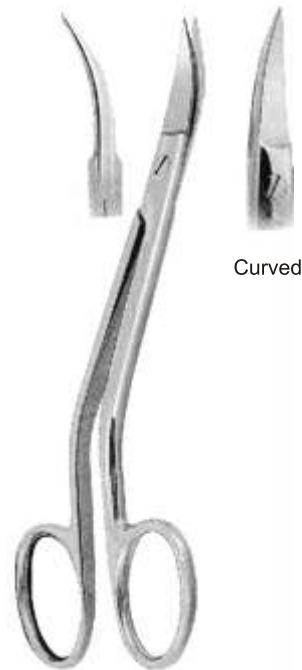

Curved

1368
Fig. 1
Neumann
cm. 12.5

GUM SCISSORS

Curved, one blade serrated



1369
Fig. 1
La Grange
cm. 10.5

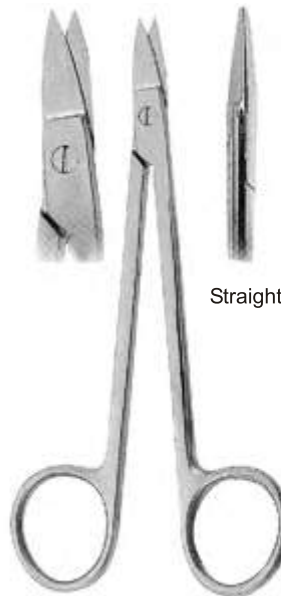

Straight

1370
Fig. 1
Qinby
cm. 12.5

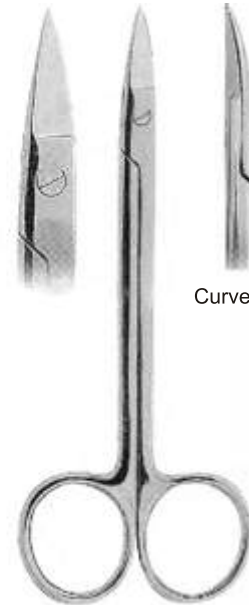

Curved

1371
Fig. 2
Qinby
cm. 12.5



Straight

1372
Fig. 1
Kelly
cm. 16

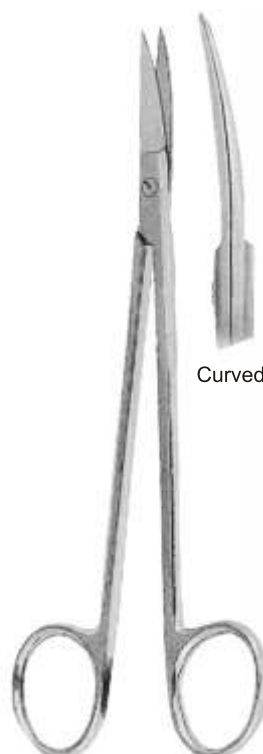

Curved

1373
Fig. 2
Kelly
cm. 16

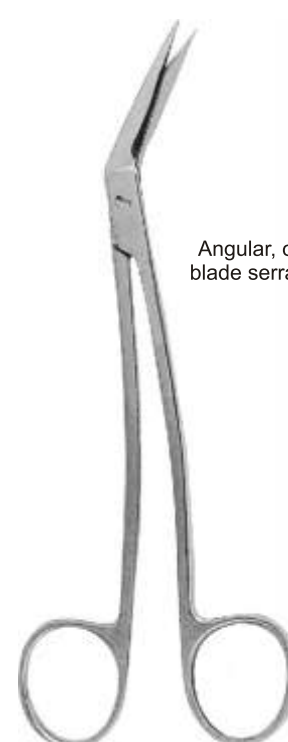

Angular, one
blade serrated

1374
Fig. 1
Locklin
cm. 16, 5

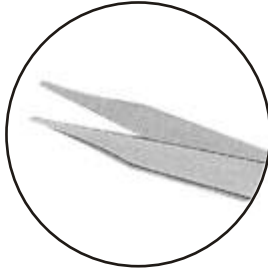

Scissors provide better cutting quality and wear resistance.

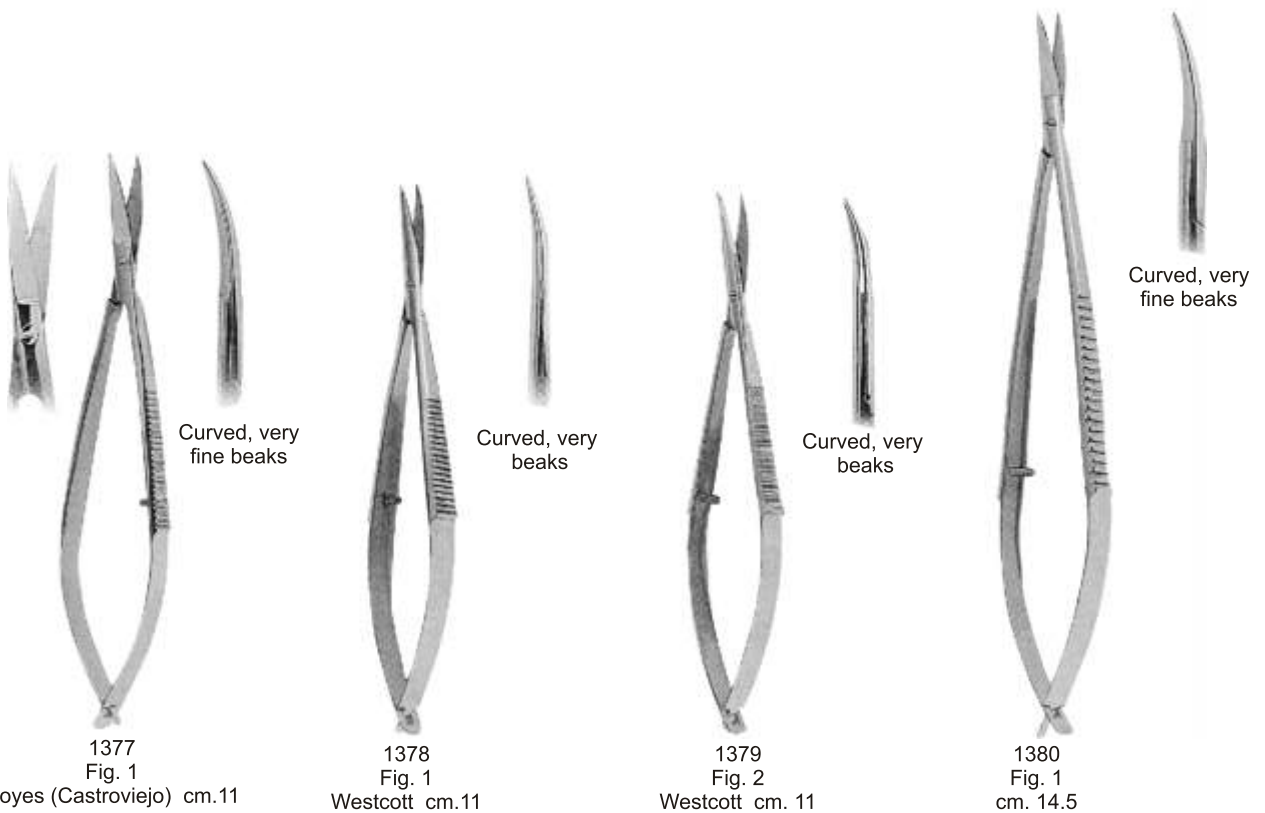
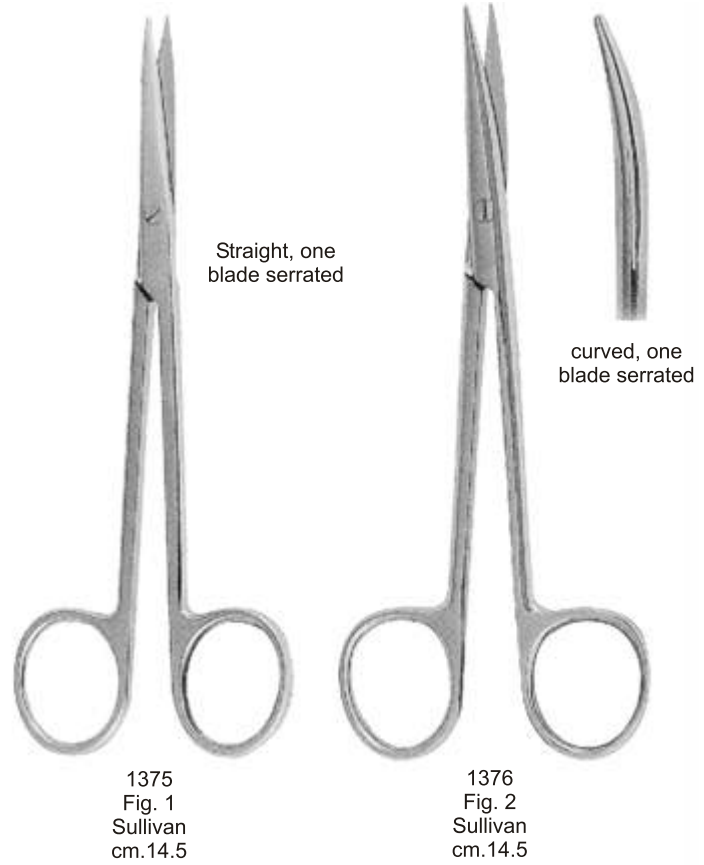

SURGICAL SCISSORS

LIGATURE SCISSORS



1381
Fig.1
Spencer
cm.9



1382
Fig.2
Spencer
cm.9

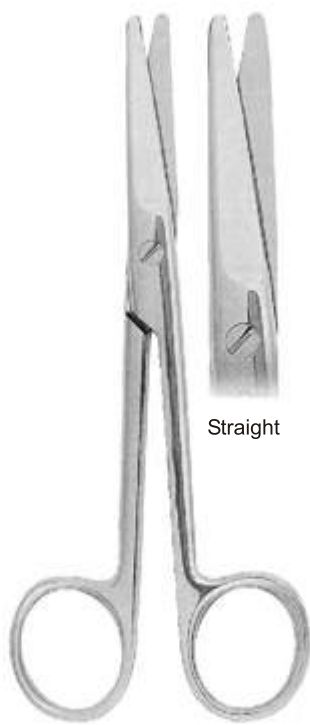

Straight

1383
Fig.1
Mayo
cm.14.5

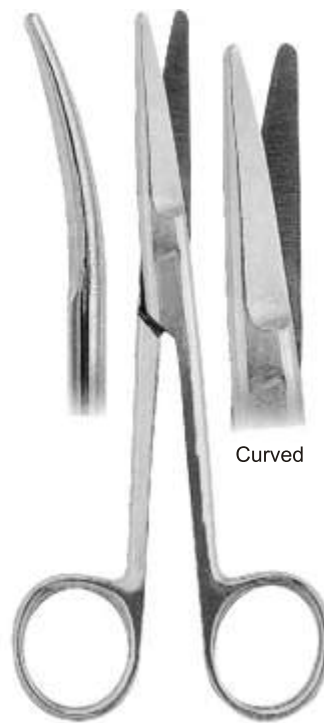

Curved

1384
Fig.2
Mayo
cm.14.5

DISSECTING SCISSORS

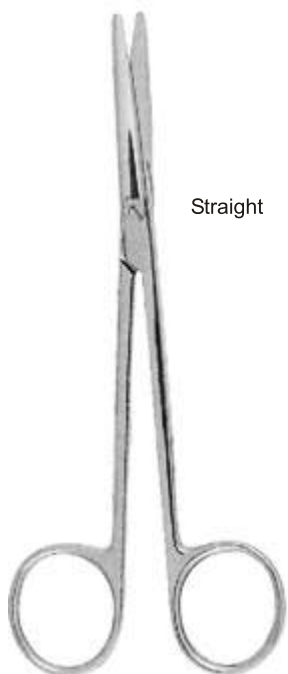

Straight

1385
Fig.1
Metzencaum

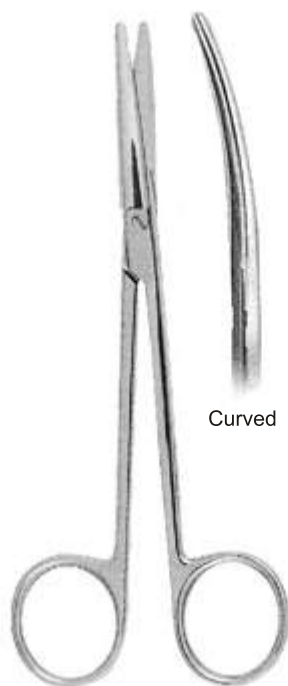

Curved

1386
Fig.2
Metzencaum



Straight

1387
Fig.1
Metzencaum Delikat

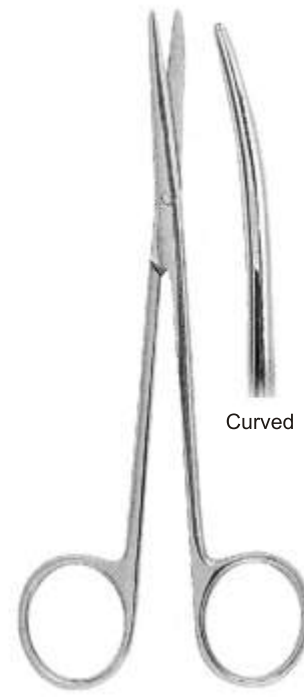

Curved

1388
Fig.2
Metzencaum Delikat

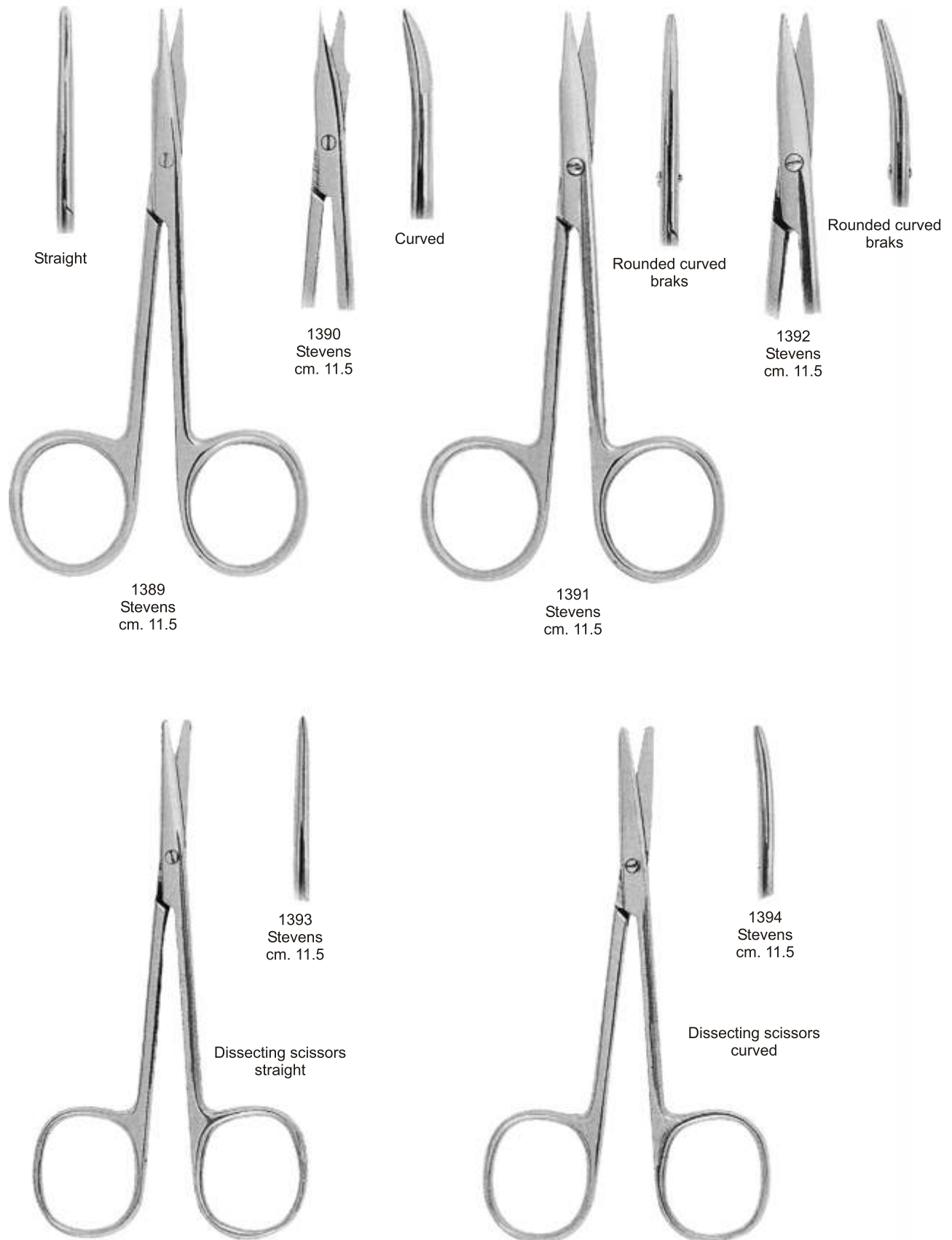

SCALPEL HANDLES - SCALPEL BLADES



1395 Fig. 3 1396 Fig. 3G 1397 Fig. 8 1398 Fig. 7 1399 Fig. 5 1400 Fig. 5A



1401 Fig.12D Double cutting edge 1402 Fig. 15C



1403 Fig. 10 1404 Fig. 11 1405 Fig. 12



1406 Fig. 13 1407 Fig. 15



1408
Olsen-Hegar
cm 14



1409
Baumgartner
cm 14.5



1410
Crile-Wood
cm. 15

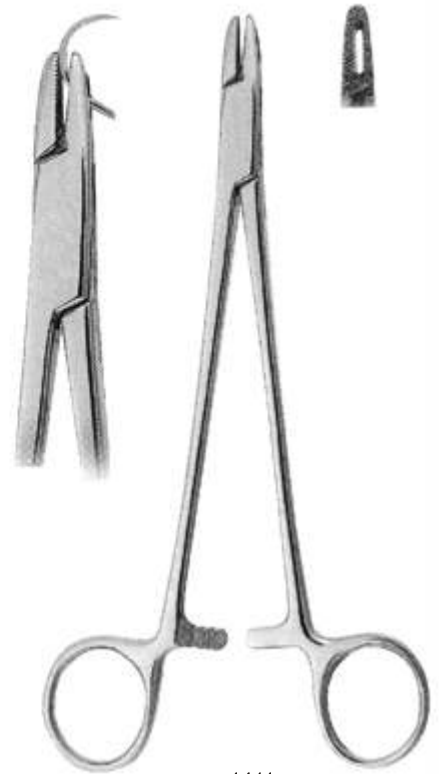

1411
Adson
cm. 17.5

NEEDLE HOLDERS



1412
Mayo-Hegar
cm.16



1413
Mayo-Hegar
cm. 18



1414
Toennis



Needle Holder and
Scissors Combined

1415
Gillies
cm.16



1416
Derf
cm.12



1417
Lichtenberg
cm.17



1418
Eiselberg-Mathieu
cm.19.5



1419
Arruga
cm.16

Needle Holder and Scissors
Combined



1420
Mathieu
cm.14



1421
Mathieu
cm.17



1422
Mathieu
cm.17

NEEDLE HOLDERS





Stainless steel syringe

1431

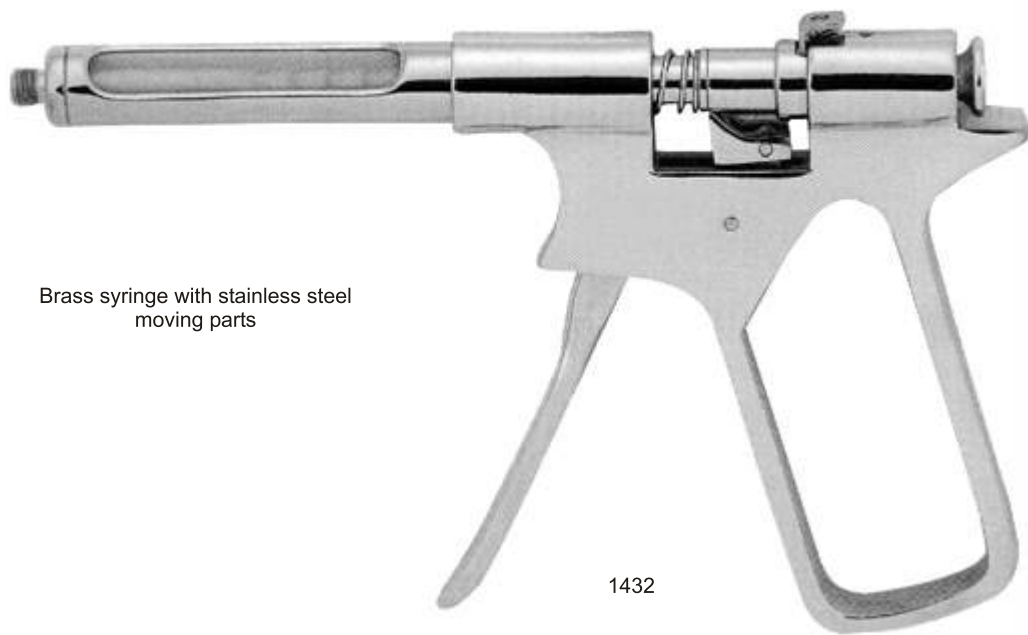

Brass syringe with stainless steel moving parts

1432



1433

Autoclavable plastic protection sleeve



1434
Syringe stand

DENTAL SYRINGES



1435



1436-P1

Spare cap with metric thread



1438



1439



1440-P2
Spare cap with
Without thread



1441



1442

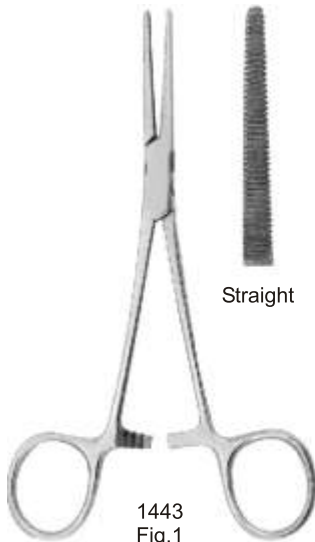

Straight

1443
Fig.1
Crile
cm.14



Curved

1444
Fig.2
Crile
cm.14



Straight

1445
Fig.1
Kocher 1x2
cm.14

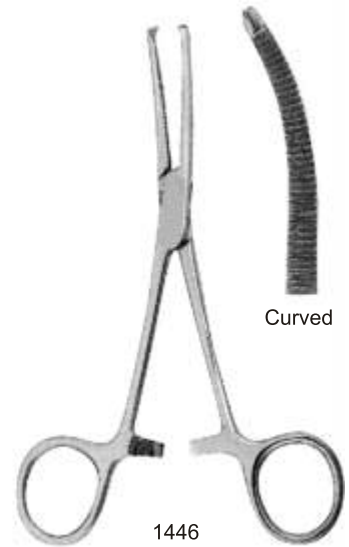

Curved

1446
Fig.2
Kocher 1x2
cm.14



Straight

1447
Fig.1
Pean
cm.14

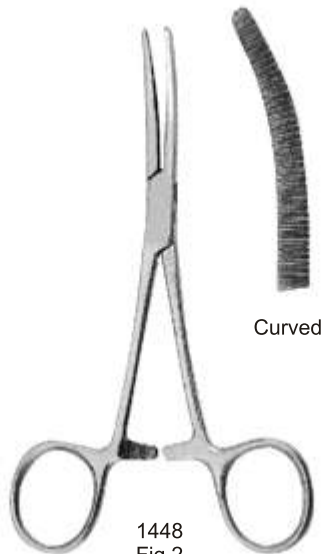

Curved

1448
Fig.2
Pean
cm.14

HAEMOSTATIC FORCEPS



Straight

1449
Fig.1
Micro-Mosquito
cm.10



Curved

1450
Fig.2
Micro-Mosquito
cm.10



1451
Fig.1
Micro-Mosquito 1x2
cm.10



1452
Fig.2
Micro-Mosquito 1x2
cm.10

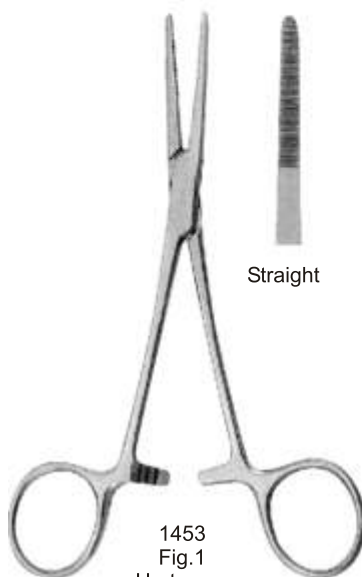

Straight

1453
Fig.1
Hartmann
cm.10

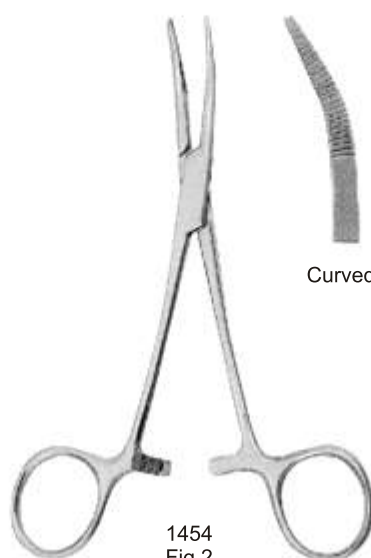

Curved

1454
Fig.2
Hartmann
cm.10



Straight

1455
Fig.1
Micro-Mosquito
cm.10



Curved

1456
Fig.2
Micro-Mosquito
cm.10

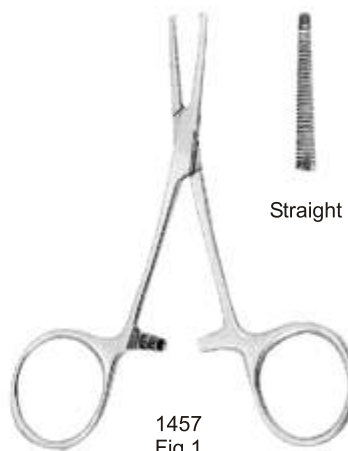

Straight

1457
Fig.1
Micro-Mosquito 1x2
cm.10

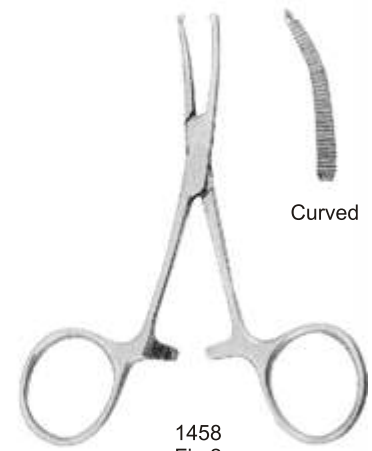

Curved

1458
Fig.2
Micro-Mosquito 1x2
cm.10



Straight

1459
Fig.1
Hartmann
cm.10

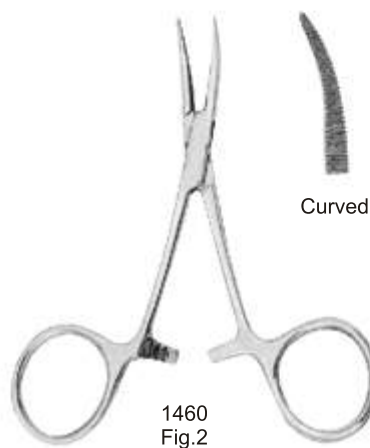

Curved

1460
Fig.2
Hartmann
cm.10

TOWEL CLAMPS



1461
Fig.1
Backhaus
cm.8



1462
Fig.2
Backhaus
cm.11



1463
Fig.3
Backhaus
cm.13



1464
Schaedle
cm.9



1465
Jones
cm.9

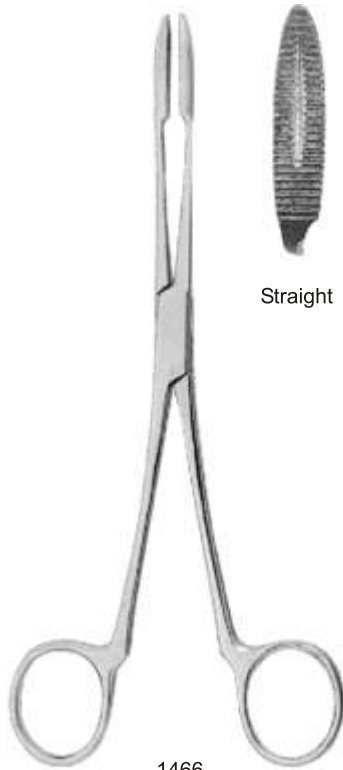

Straight

1466
Gross-Maier
cm.20

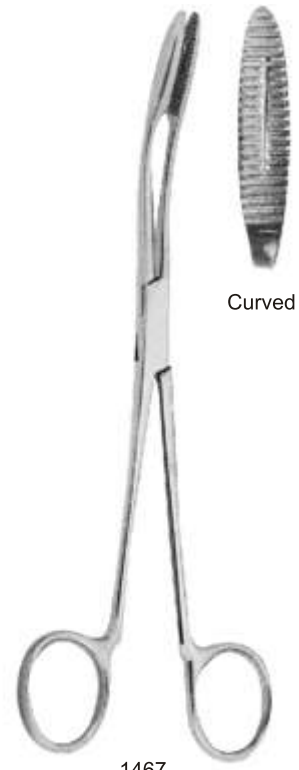

Curved

1467
Gross-Maier
cm.20



Straight

1468
Gross-Maier
cm.25



Curved

1469
Gross-Maier
cm.25

MOUTH GAGS - TONGUE FORCEPS



1470
Molt
cm.14

For adults

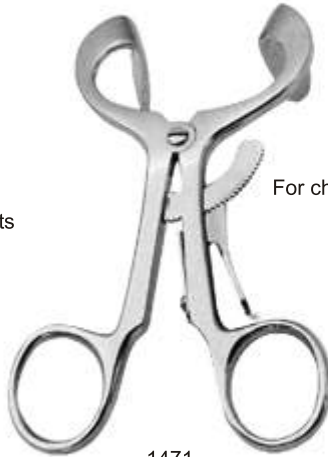

1471
Molt
cm.11

For children



1472
Roser-Koenig
cm.16



1473
Roser-Koenig
cm.19



1474
Collin
cm.16

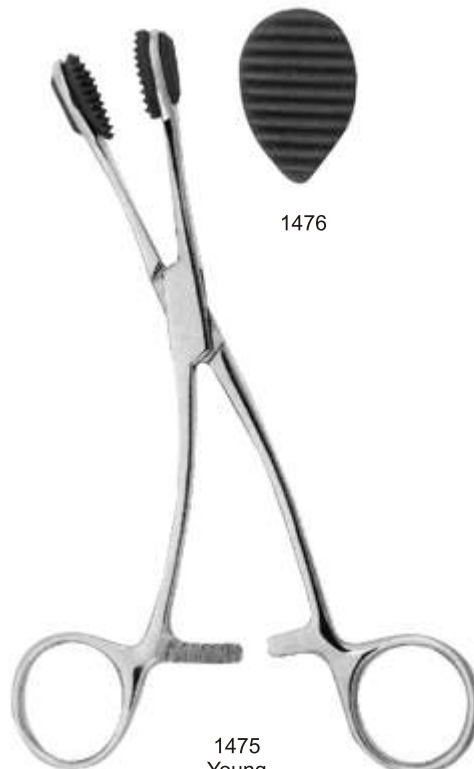

1476

1475
Young
cm.17



1477
Columbia
cm.14.5

1478
Sternberg
cm.14

1479
Sternberg
cm.16

1480
Sternberg
cm.14

1481
Oringer medium
cm.11x8

TONGUE DEPRESSOR

CHEEK RETRACTOR

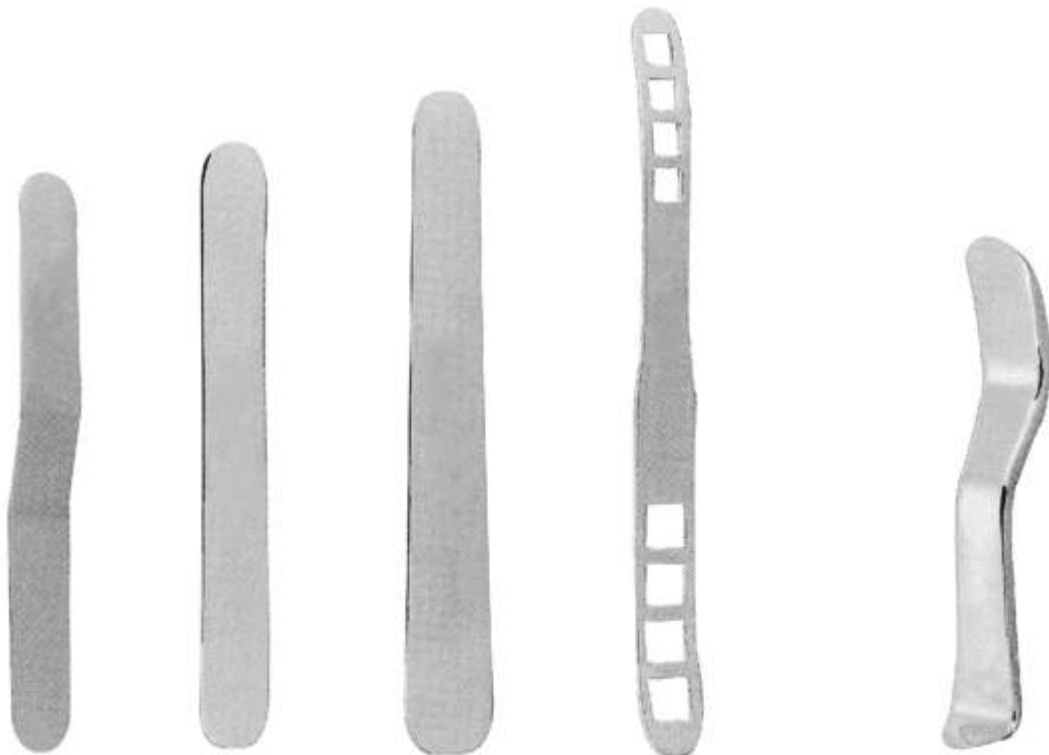

1482
cm.14.5

1483
cm.14.5

1484
Buchwald
cm.17

1485
Brunings
cm.19

1486
cm.14

RETRACTORS

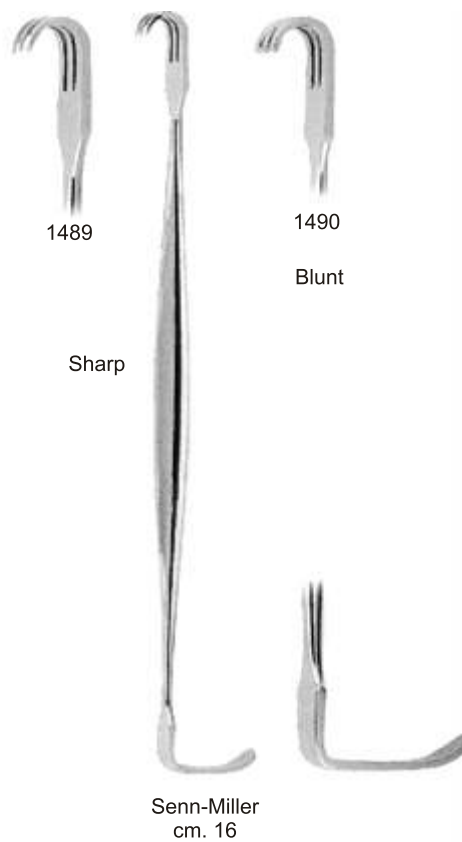
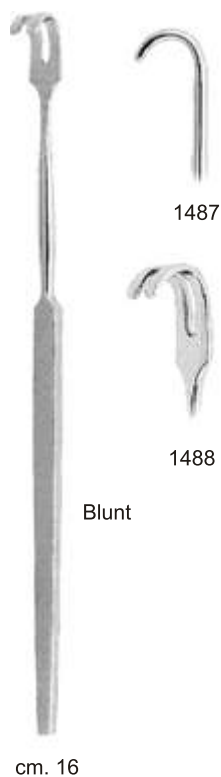



Williger
cm.13



1493



1494

Straight, sharp



Williger
cm.13



1495



1496

Left, sharp



Williger
cm.13



1497



1498

Right, sharp



Williger
cm.13



1499



1500

Straight, blunt



Williger
cm.13



1501



1502

Left, blunt



Williger
cm.13



1503



1504

Right, blunt

RETRACTORS

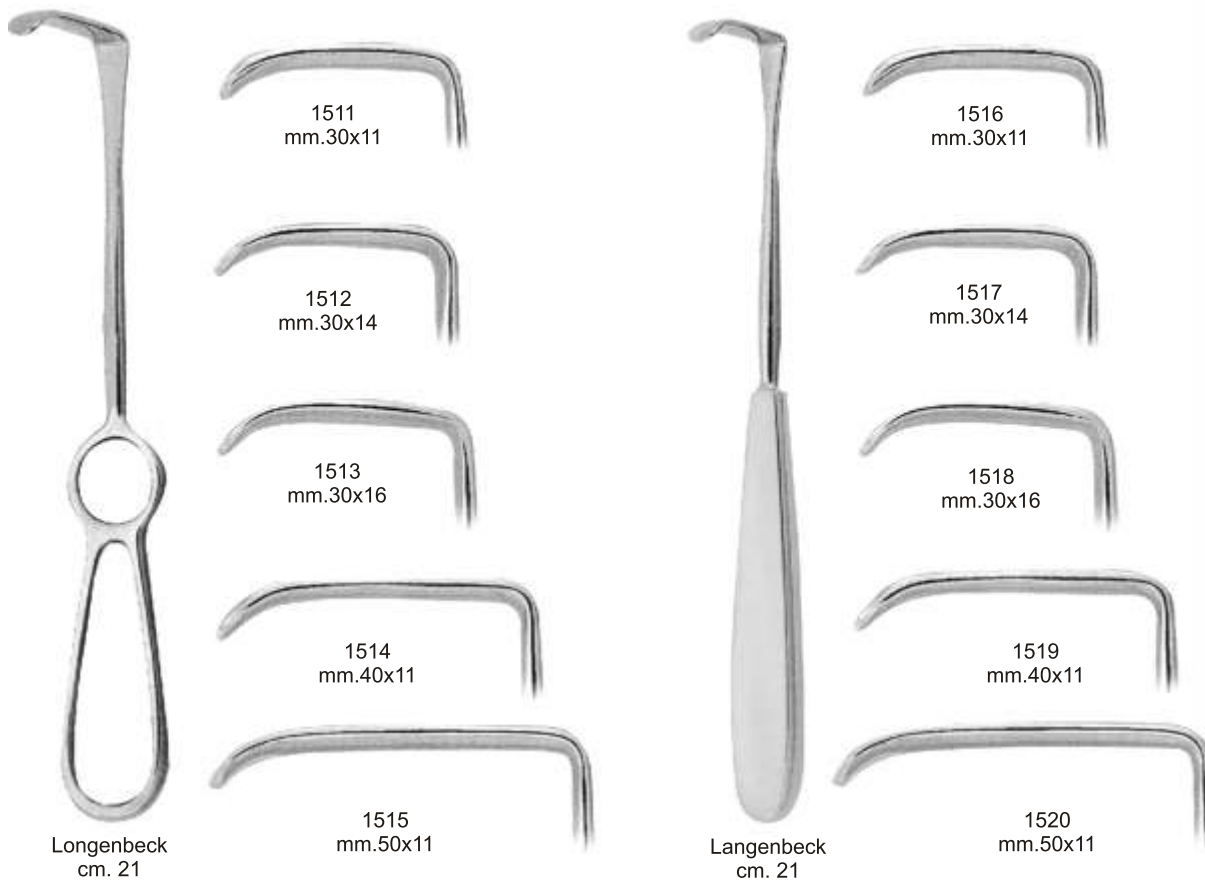
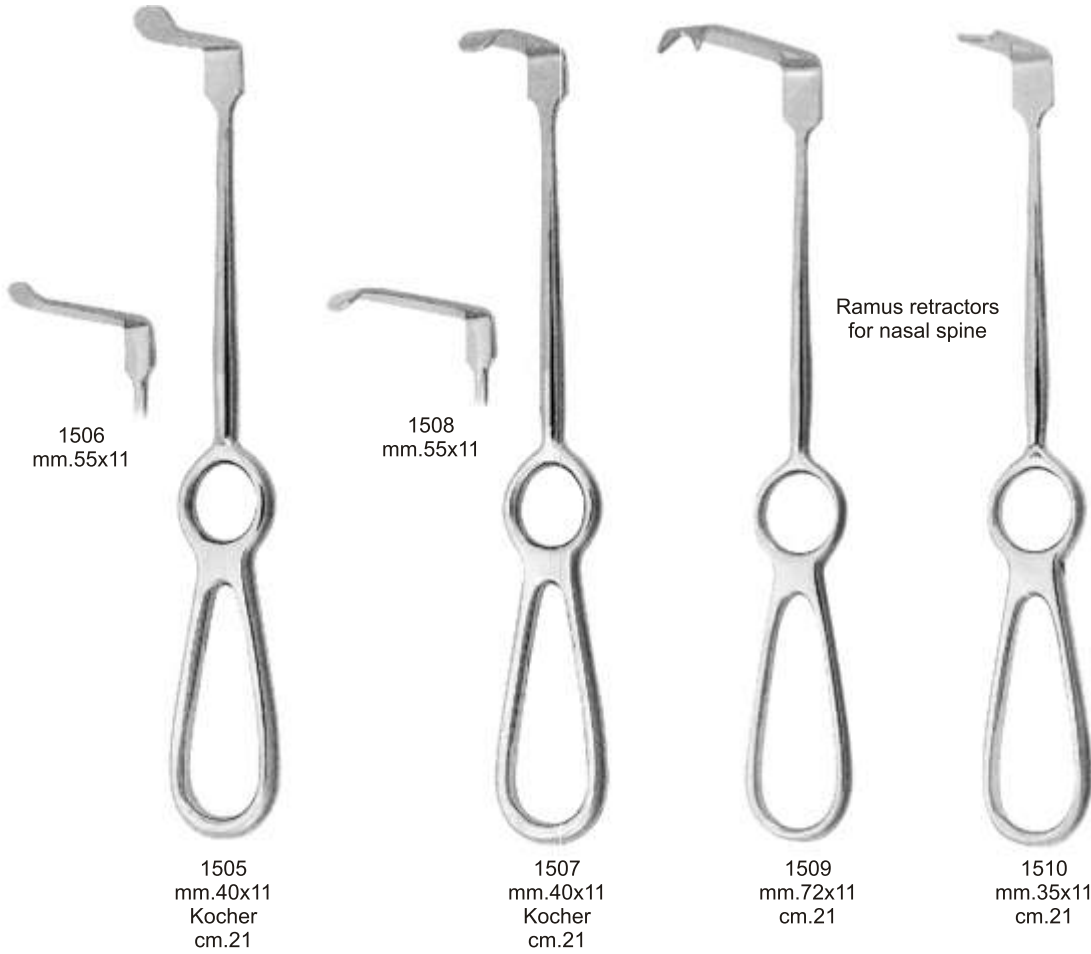

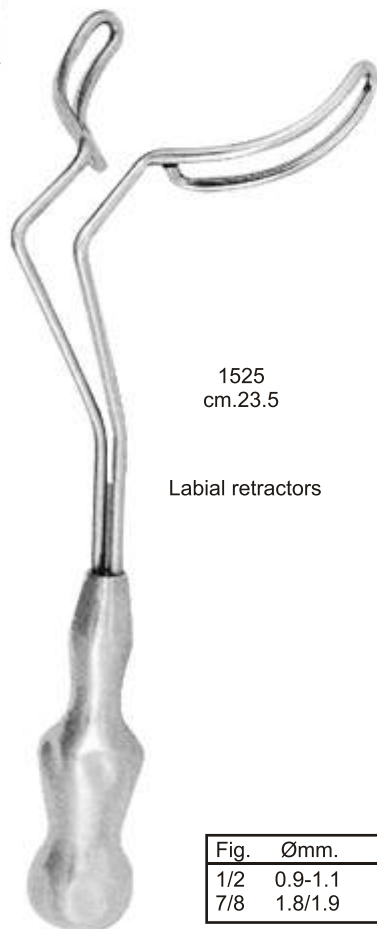
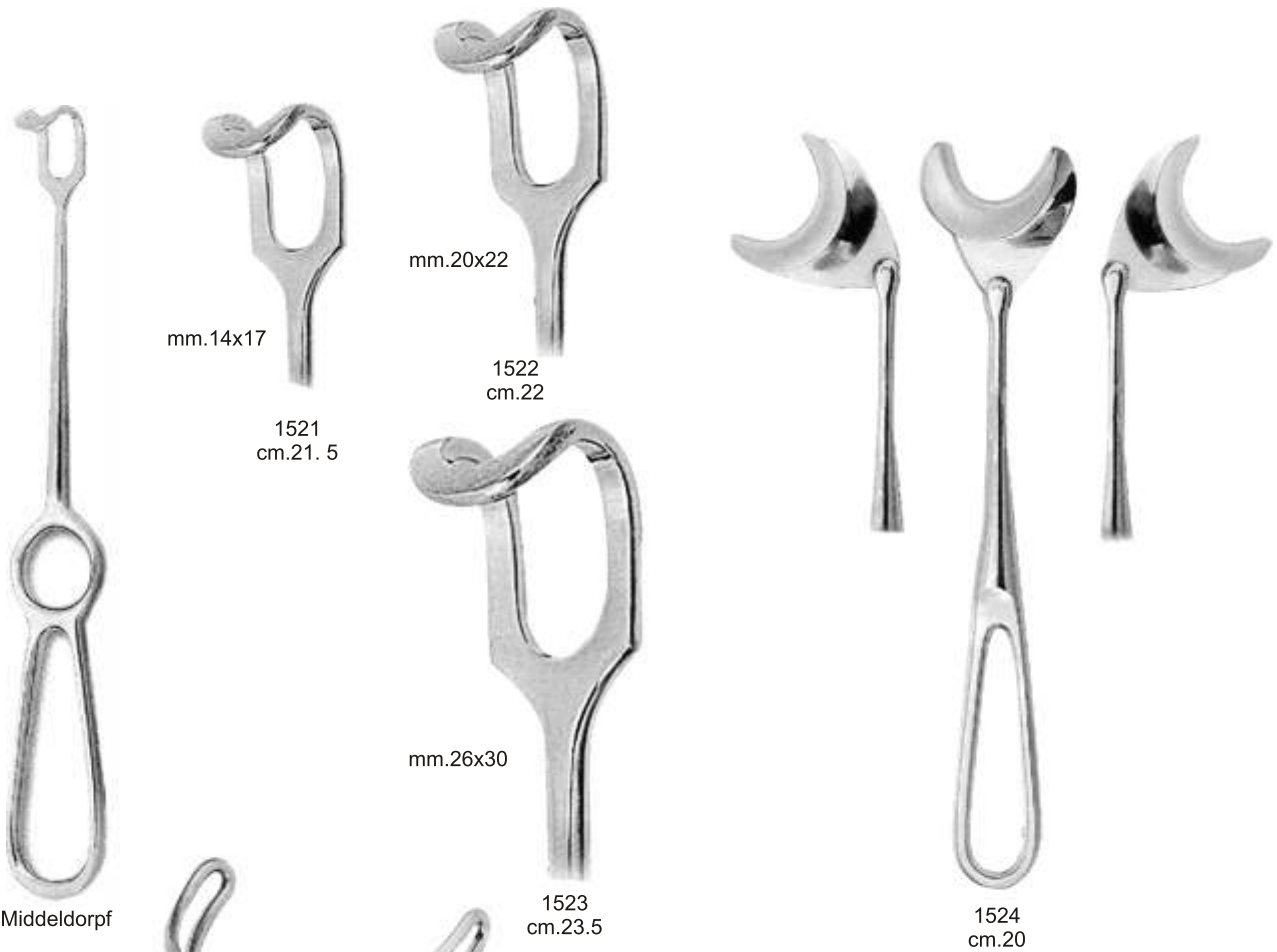

ANTRUM PROBES

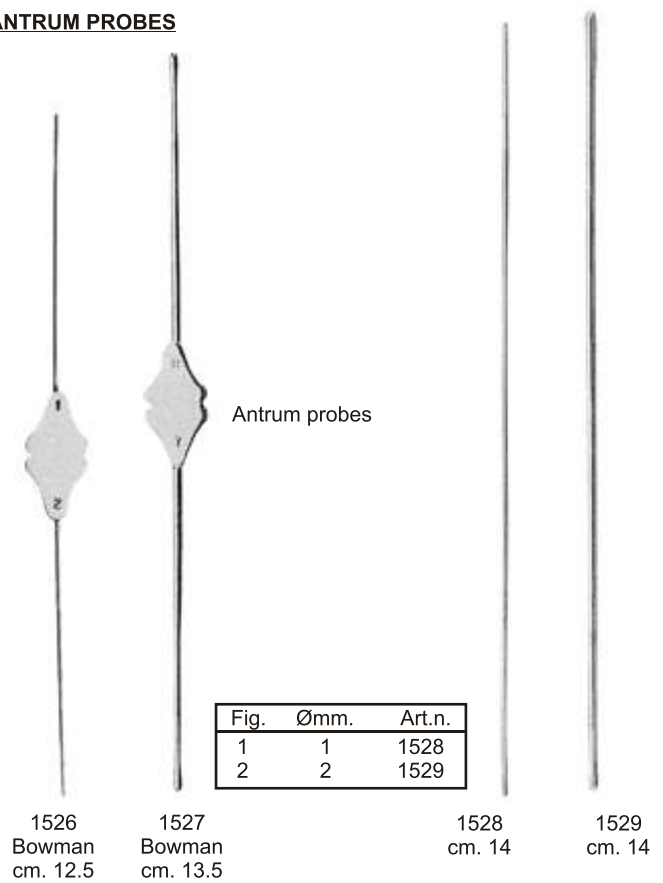
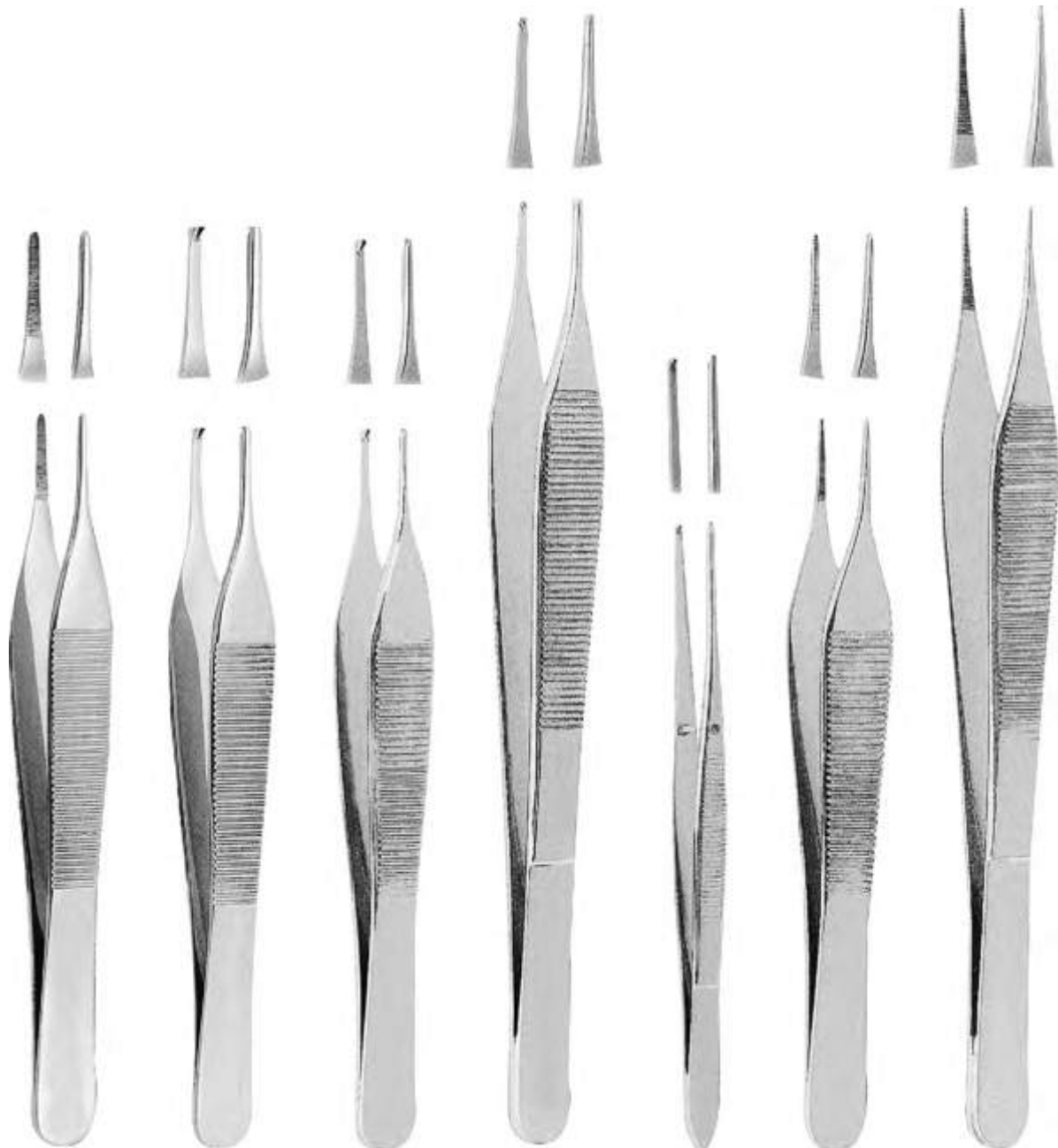

Fig.	Ømm.	Art.n.
1/2	0.9-1.1	1526
7/8	1.8/1.9	1527

Fig.	Ømm.	Art.n.
1	1	1528
2	2	1529

TISSUE PLIERS



1530
Fig.1
Adson

1531
Fig.1
Adson 1x2

1532
Fig.1
Micro-Adson 1x2

1533
Fig. 2
Micro-Adson 1x2

1534
Molto fine
very fine

1535
Micro-Adson
cm. 12

1536
Micro-Adson
cm. 15

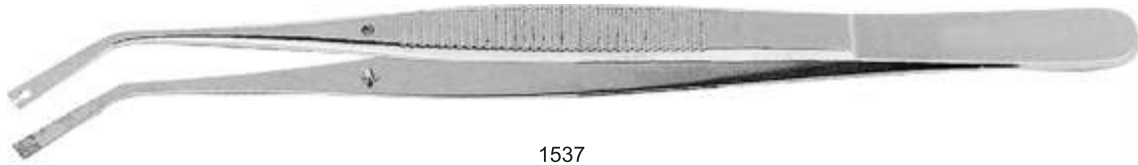

1537
Fig. 1
cm. 15
Suture Pliers



1538
Adson Brown
non traumatic
cm. 12



1539
Fig. 1
Semken-Taylor
cm. 12.5



1540
Fig. 2
Semken-Taylor
cm. 12.5

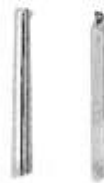

1541
Fig. 1
Semken-Taylor 1x2
cm. 12.5



1542
Fig. 2
Semken-Taylor 1x2
cm. 12.5

VERY FINE TIPS



1543
Fig. 1
cm. 12.5



1544
Fig. 2
cm. 12



1545
Fig. 3
cm. 11.5



1546
Fig. 4
cm. 11.5



1547
Fig. 5
cm. 11.5

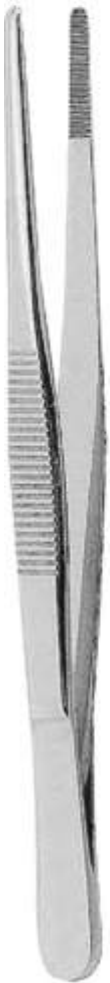

1548
Fig. 1
cm. 13



1549
Fig. 2
cm. 14



1550
Fig. 3
cm. 15



1551
Fig. 4
cm. 18



1552
Fig. 5
cm. 20.5

SURGICAL SALIVA EJECTORS

Stainless Steel Saliva Ejectors

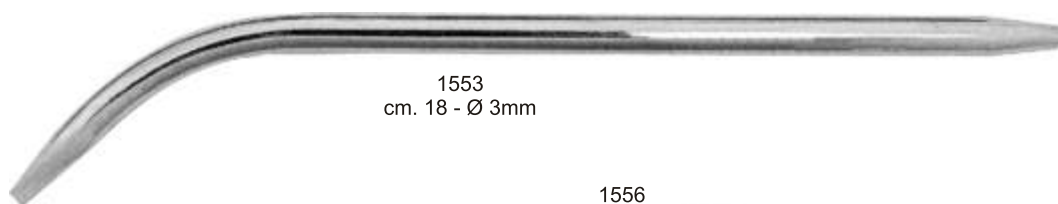

1553
cm. 18 - Ø 3mm



1554
cm. 18 - Ø 4mm



1555
cm. 18 - Ø 5mm



1556
Fig. 12FR
Frazier
cm. 15 - Ø 4mm



1557
Fig. 10FR
Frazier
cm. 15 - Ø 3.3mm



1558
Fig. 8FR
Frazier
cm. 15 - Ø 2.7mm



1559
Fig. 6FR
Frazier
cm. 15 - Ø 2mm

ASPIRATOR TIPS



1560



1561

1562

Autoavailable adaptor for 1561-1562

Aspirator tips specially shaped for surgical use, autoclavable.

Compactors



1563
Fig.1

MV
1564
Fig.2



1565
cm.17,5
Bone thickness gauge



Bone
injector

1567
cm. 16
Ø 4.5 mm

1566
cm.16
Ø2,5 mm

Bone
curette



1569
Fig. 3



Bone well

1568
Ø cm. 3.5
h.cm.3.5



Surgical mallets

Lead filling

1570
Partsch
cm. 19

1571
Mead
cm. 19.5



1579
N° 2 plastic inserts
autoclavable max 140°

Freer single cut scalpels

0.7 mm 1.3 mm 1.3 mm
2.0 mm 4.0 mm 6.3 mm

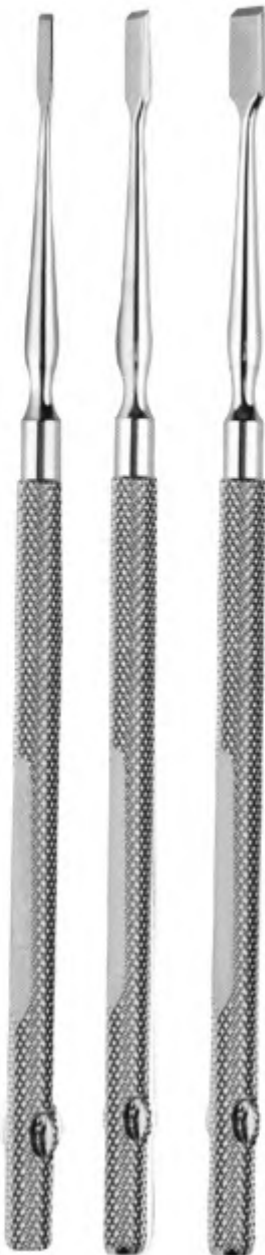

1572
Fig. 1
Freer

1573
Fig. 2
Freer

1574
Fig. 3
Freer

3.8 mm

Graduated scalpels

7.5 mm



1575
Fig. 1
mm 3.8
straight

1576
Fig. 2
mm 3.8
curved

1577
Fig. 3
mm 7.5
straight

1578
Fig. 4
mm 7.5
curved

Membrane placement instrument



1580
Buser



1581
Fig. M7
Molt



1582
Fig. M8
Molt



1583
Fig. M9
Molt



1584
Fig. 2
Hourigon



1585
Fig. Pr3
Prichard



1586
Fig. 9A
Allen



1587
Fig. GF
Goldman-Fox



1588
Williger
cm.16

OSTEOTOMES

1589
Set of 6

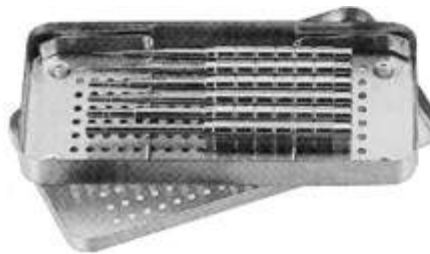

Concave end

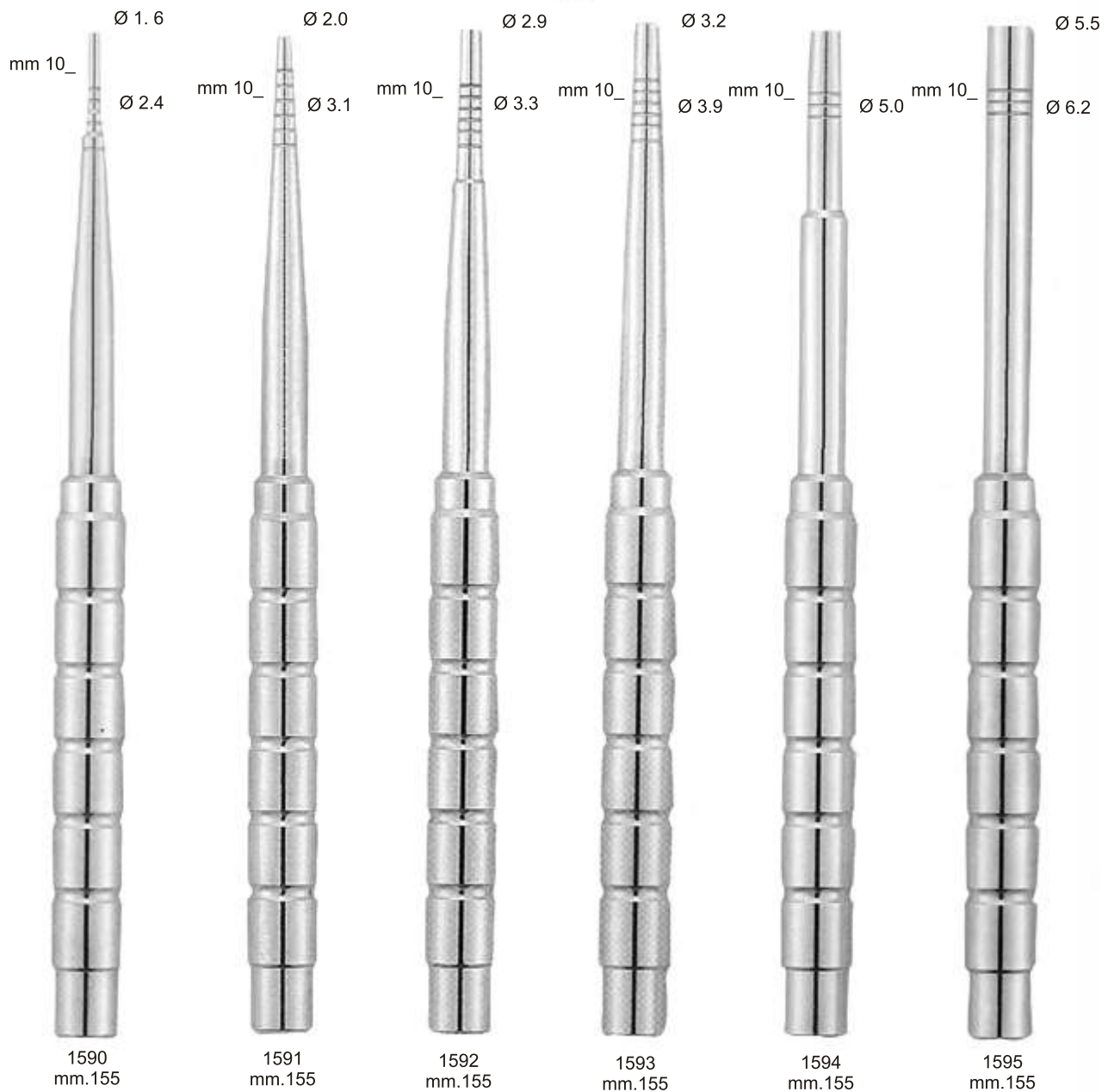

PERIOTOMES



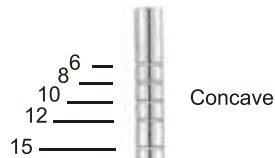
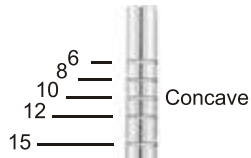

1598
Mini sinus lift kit

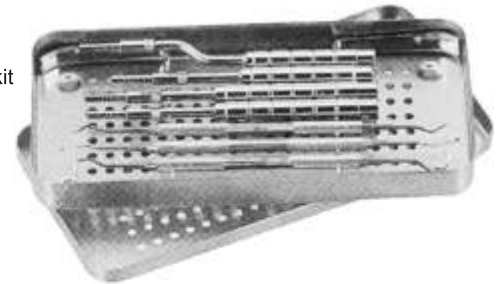

1599
mm. 165
Ø mm.3

Mini sinus lift



1603
mm. 165
Ø mm.3

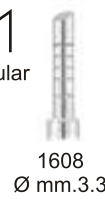
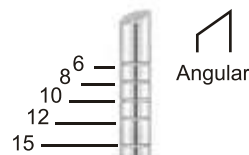

1607
mm. 165
Ø mm.3

Annular osteotomes with setting point

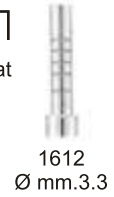
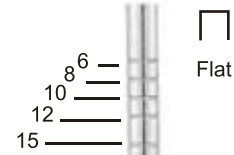

1615
Fig. 1
Hemingway

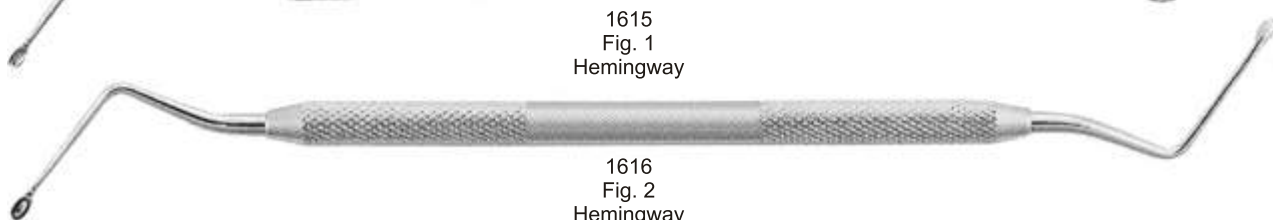

1616
Fig. 2
Hemingway

Implant site dilators

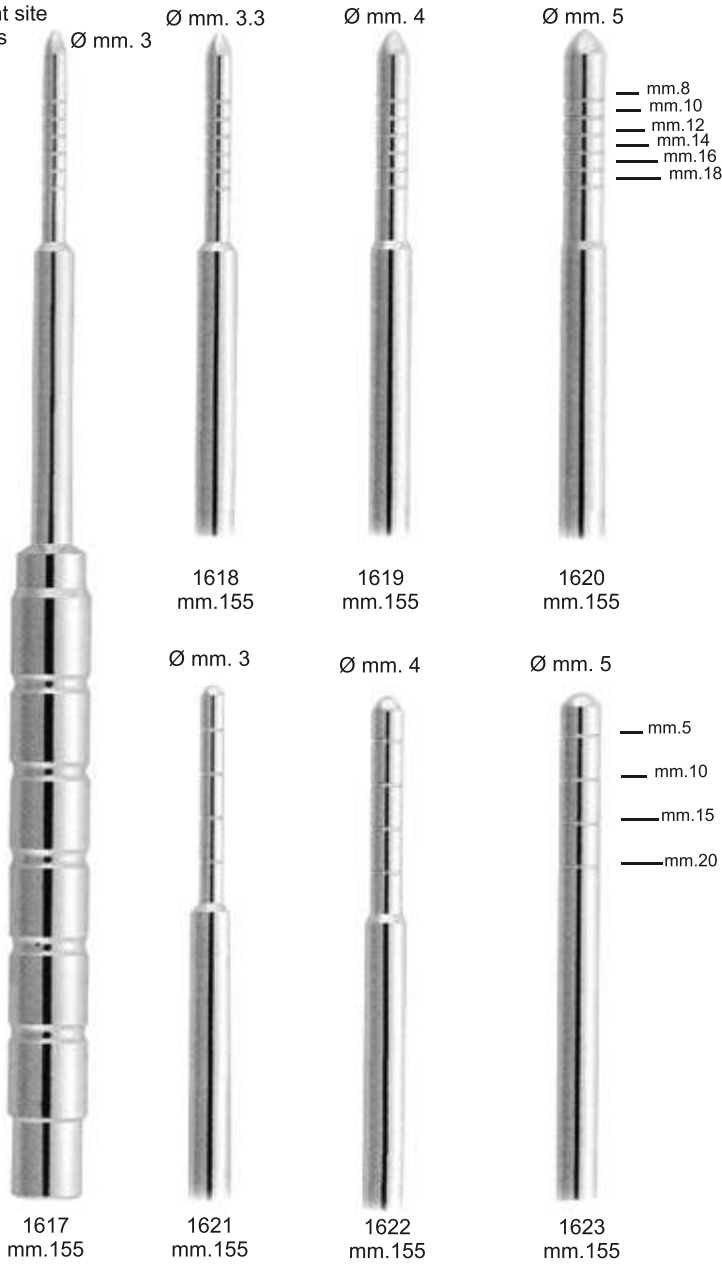

SINUS LIFT CURETTES



TREPINE BURS



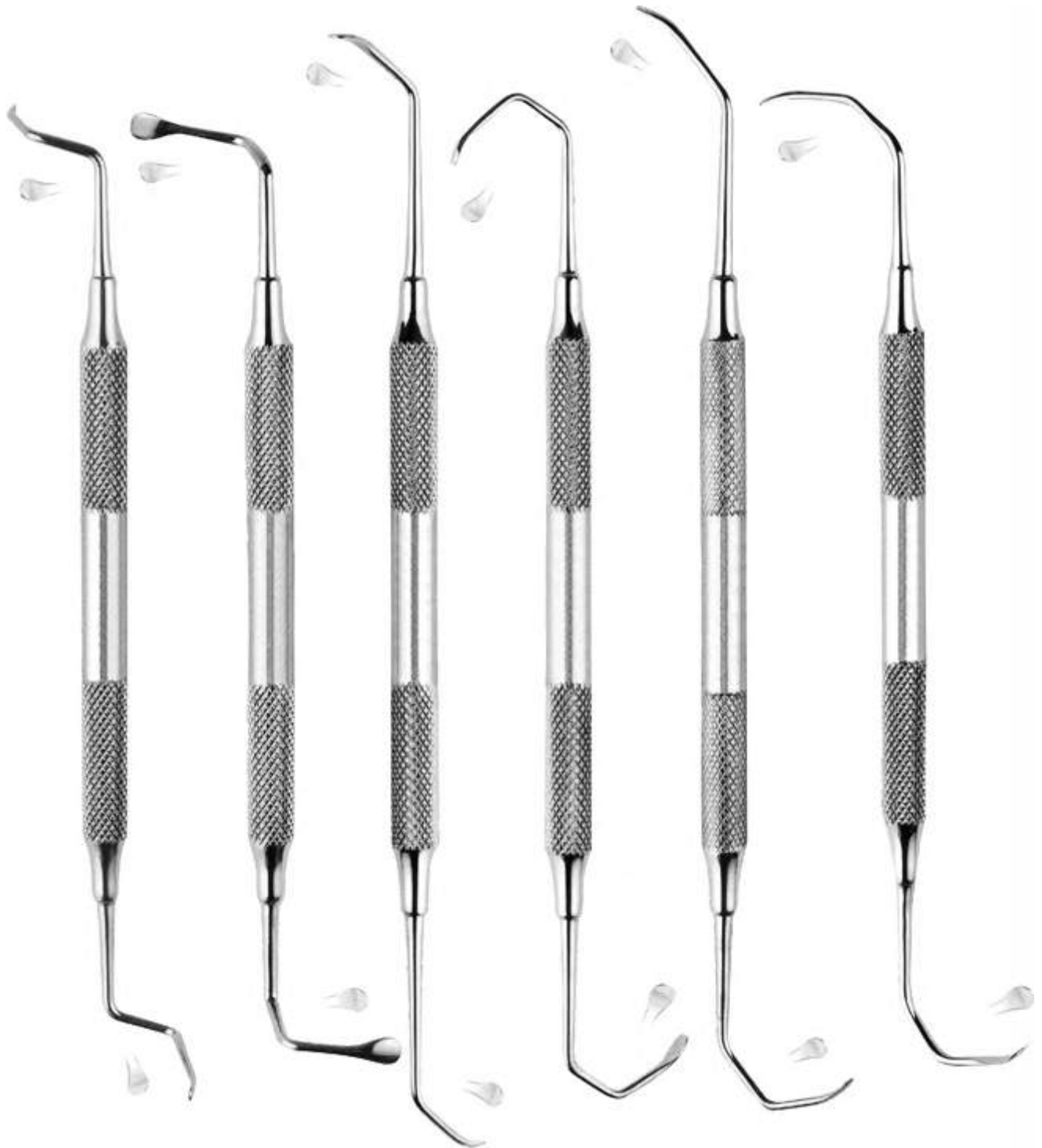

1630
Fig. 3

1631
Fig. 4

1632
Fig. 5

1633
Fig. 6

1634
Fig. 7

1635
Fig. 8

IMPLANT SURGERY

Periosteal Elevators

GLOMED
INSTRUMENTS

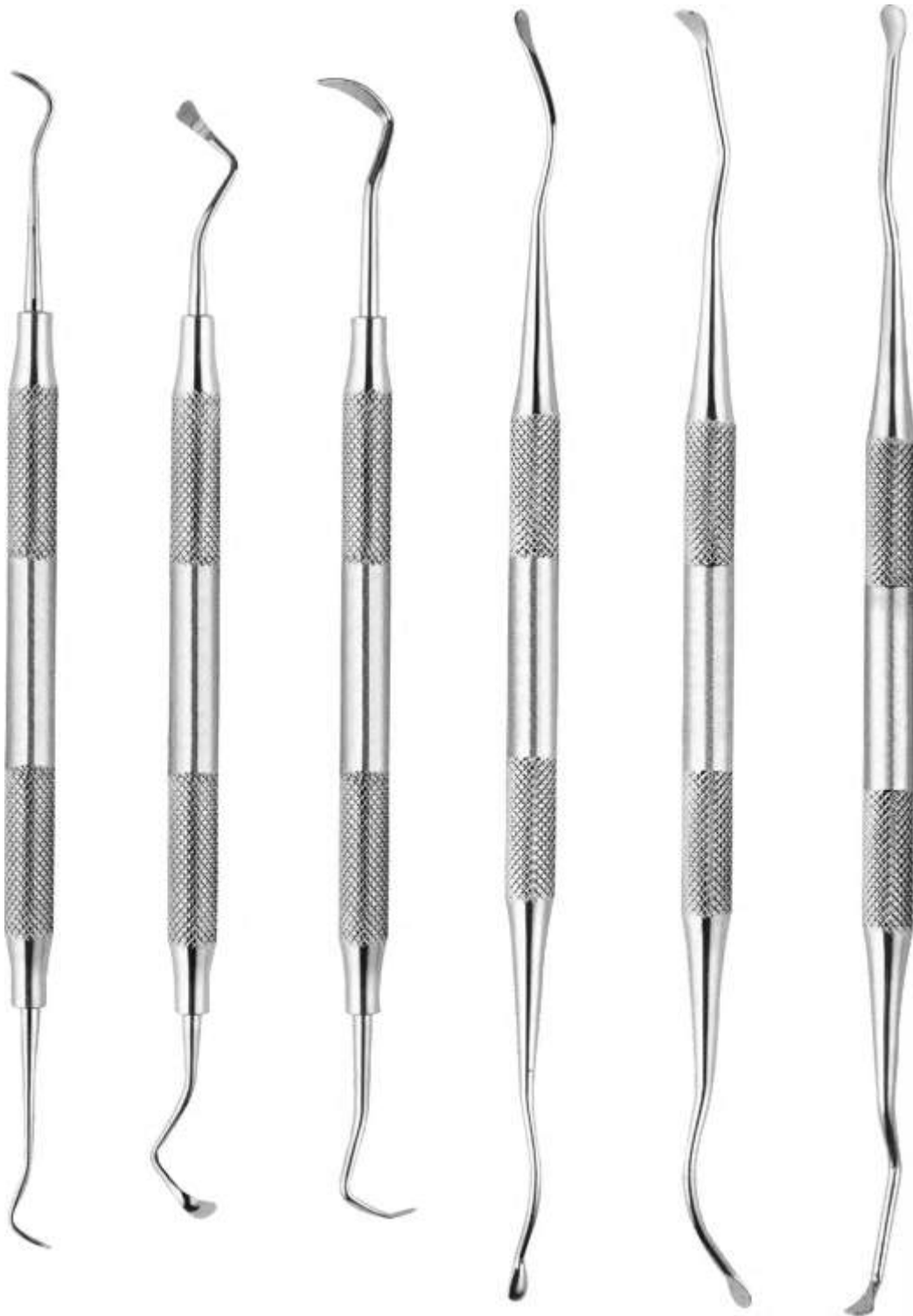

1636
Fig. 1

1637
Fig. 2

1638
Fig. 3

1639
Fig. 4

1640
Fig. 5

1641
Fig. 6

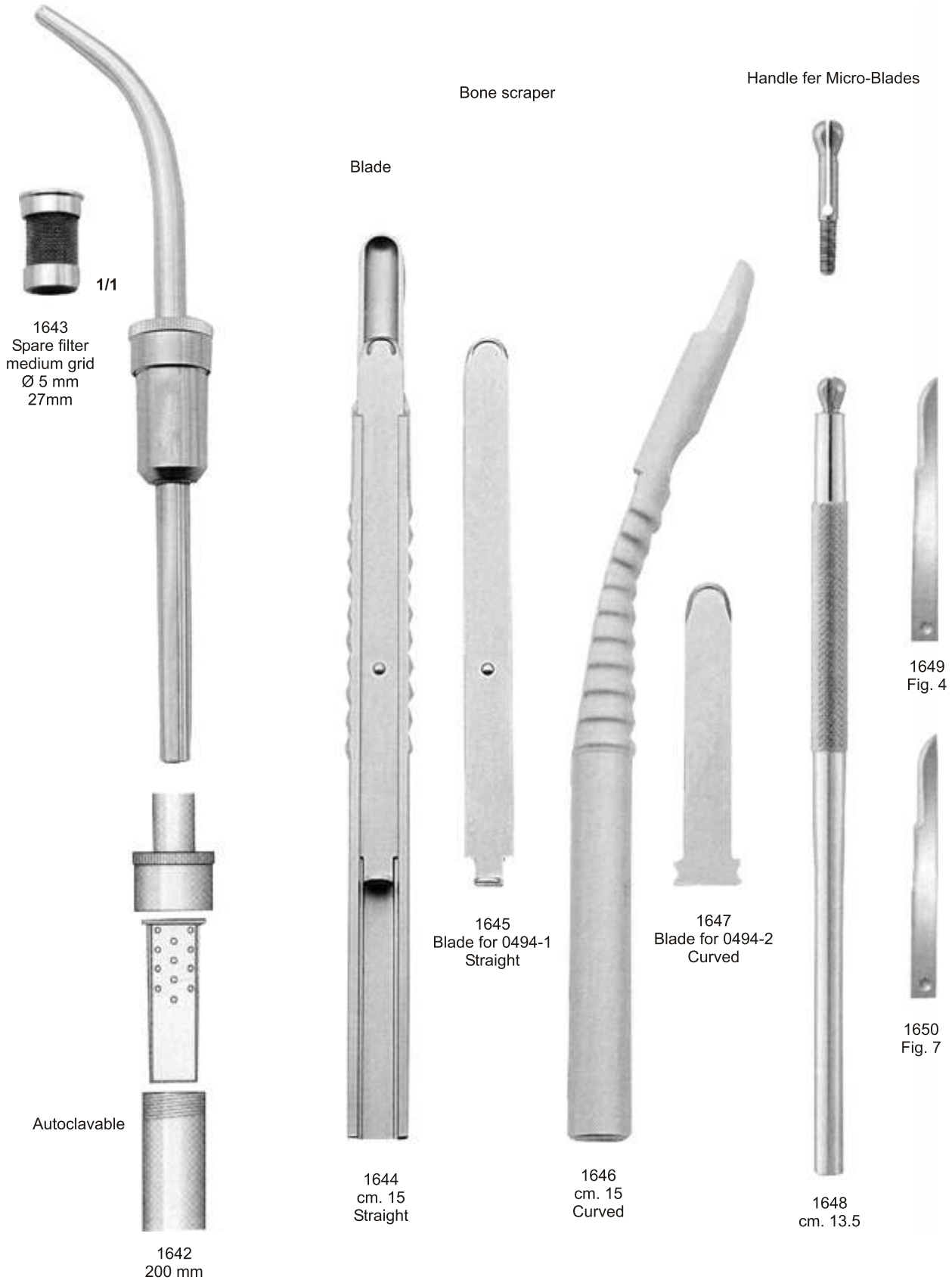

Surgical Saliva Ejector, bone filter

IMPLANT SURGERY

Implant retractors



1651
cm.23.5
Labial retractor



1652
Sternberg
cm. 14

Cheek retractor



1653
cm. 14



1654
cm. 20



1655
Middeldorpf
cm. 21.5



1656
Luer
cm. 15



1657
Blumenthal
cm. 15



1658
Blumenthal 45°
cm. 14, 5

PERIODONTAL POCKET MARKERS



1659
Fig. 1
Goldman-Fox

1660
Fig. 2
Goldman-Fox

BONE/SOFT TISSUE NIPPER



1661
Mini Friedman
cm. 12



1662
Goldman-Fox
cm. 10

COTTON AND DRESSING PLIERS



1663
Fig. 2



1664
Fig. 3
cm. 16



1665
Fig. 17
cm. 16



1666
Fig. 18
cm. 16



1667
Fig. 19
cm. 16, 5

Self-Locking



1668
Fig. 1
(Crane-Kaplan)
Goldman-Fox
cm. 15

1669
Fig.
(Crane-Kaplan)
Goldman-Fox
cm. 15



1670
Fig. 18L
Locking
cm. 16

1671
Fig. 1
cm. 15

1672
Fig. 2
cm. 15

EXPLORERS ANATOMIC HANDLE



1673
Fig. 23



1674
Fig. 2



1675
Fig. 3



1676
Fig. 3A



1677
Fig. 3R
Rhein



1678
Fig. 5



1679
Fig. 6



1680
Fig. 8



1681
Fig. 9



1682
Fig. 10



1683
Fig. 11



1684
Fig. 12



1685
Fig. 16



1686
Fig. 17



1687
Fig. 17A

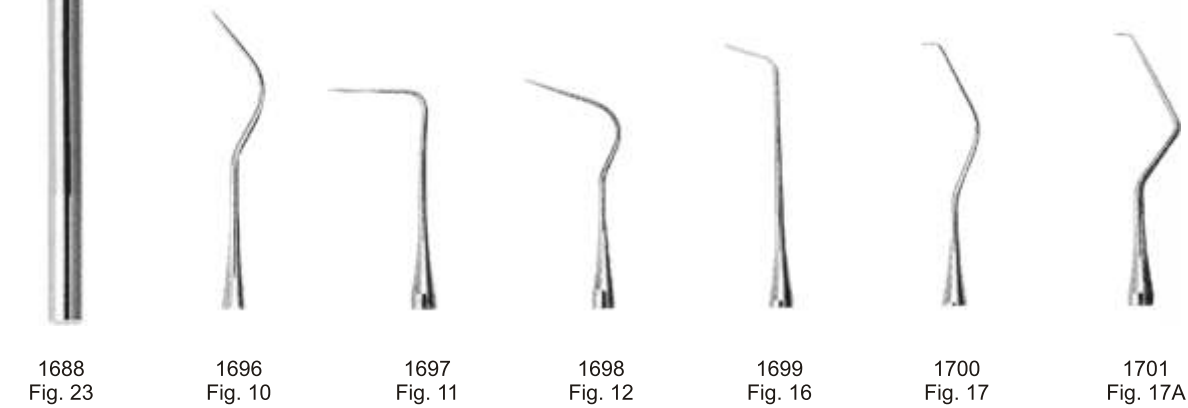
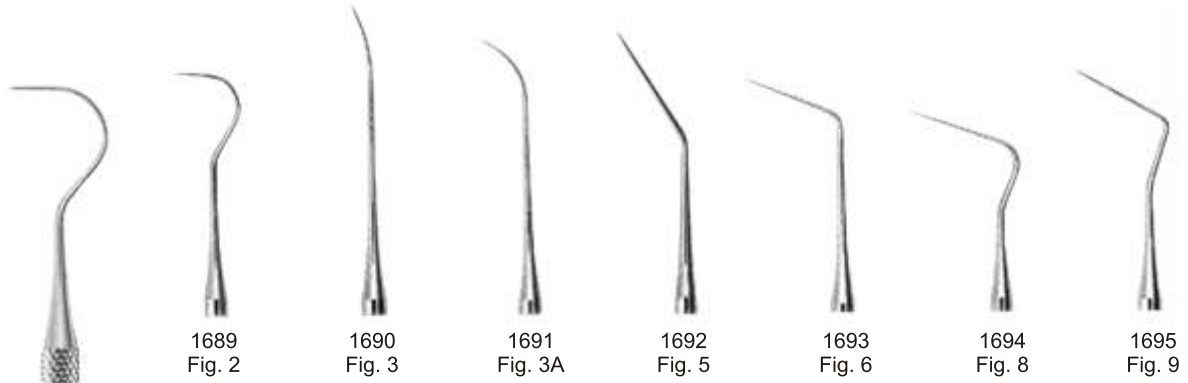

PERIODONTAL POCKET PROBES



1702
Goldman-Fox



1703
Fig. 1N



1704
Fig. 2N



1705
Fig. 2N



1706
Goldman-Fox
Williams



1707
Fig. 1N
Nabers



1708
Fig. 2N
Nabers



1709
Fig. UT 1/2
Cattoni

1710
Fig. 11/12AF



1711
Fig. 23/17



1712
Fig. 23/17A



1713
Fig. 2



1714
Fig. 2A



1715
Fig. 3

ROOT CANAL EXPLORERS



1716
Fig. 16/23



1717
Fig. 16/3



1718
Fig. 6/9



1719
Fig. 6/1



1720
Fig. 6/17



1721
Fig. 6/23

DOUBLE-ENDED EXPLORERS



1722
Fig. UT 1 /2
Cattoni



1723
Fig. 23/17

1724
Fig. 23/17A

1725
Fig. 2

1726
Fig. 2A

1727
Fig. 3

ROOT CANAL EXPLORERS



1728
Fig. 16/23

1729
Fig. 16/3

1730
Fig. 6/1

1731
Fig. 6/17

1732
Fig. 6/23

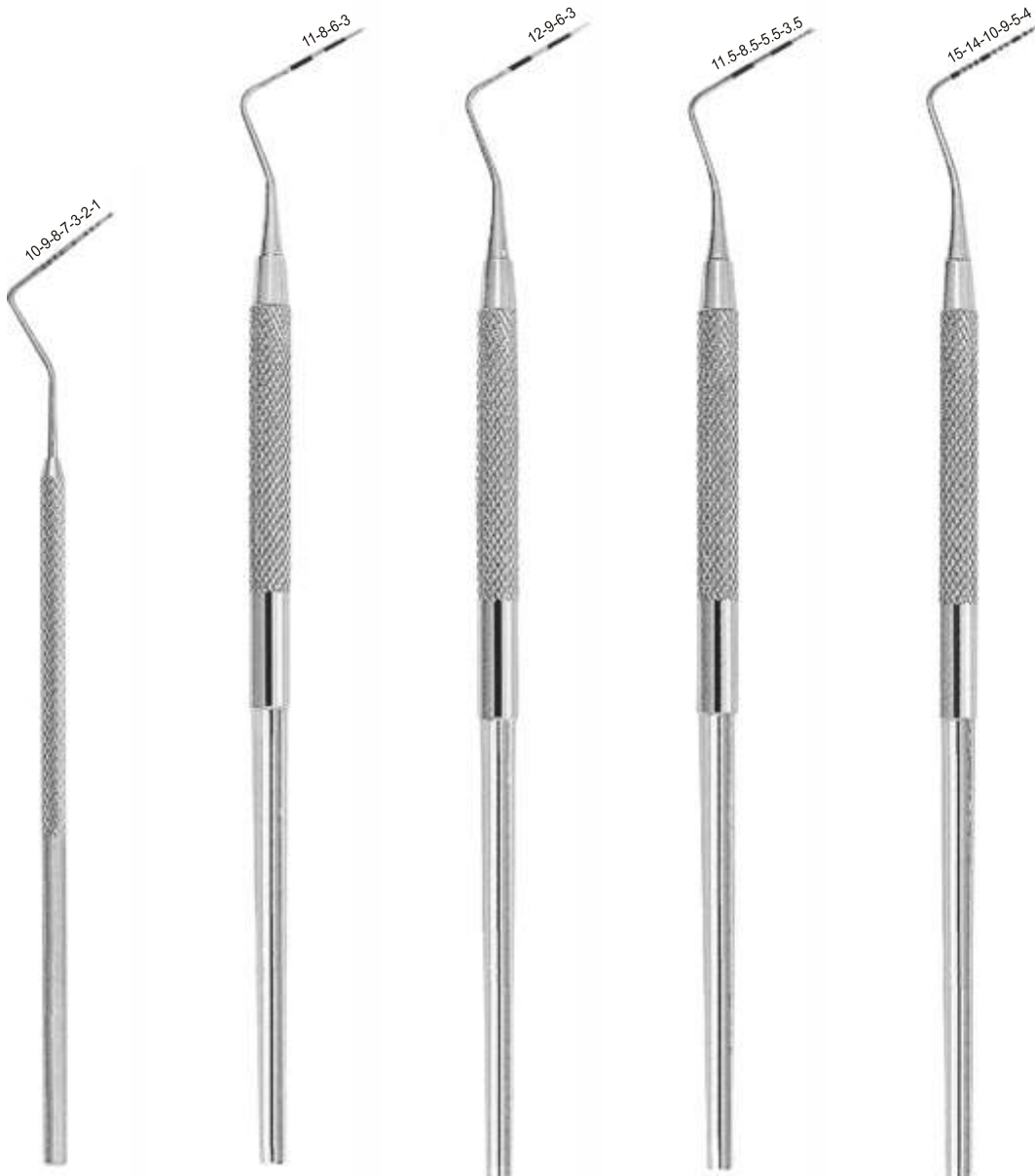

1733
CP-C

1734
CP-11

1735
CP-12

1736
CP-12S
O.M.S.

1737
CP-15

DOUBLE-ENDED EXPLORERS



1738
Williams

1739
Merrit A

1740
Merrit B

1741
Goldman
Fox
Punta Piatta

1742

1743
26 G



1744
Fig. 23
Goldnan-Fox
Punta Piatta
Flat tip



1745
Fig. 23



1746
Fig. 23
Williams



1747
Fig. 17
Goldman-Fox
Punta Piatta
Flat tip



1748
Fig. 17



1749
Fig. 17
Williams



1750
Fig. 3
Goldman-Fox
Punta Piatta
Flat tip



1751
Fig. 16
Goldnan-Fox
Punta Piatta
Flat tip



1752
Fig. 16
Williams



1753
Fig. 23/CP11



1754
Fig. 23/CP12

COMBINATION EXPLORERS - PROBES

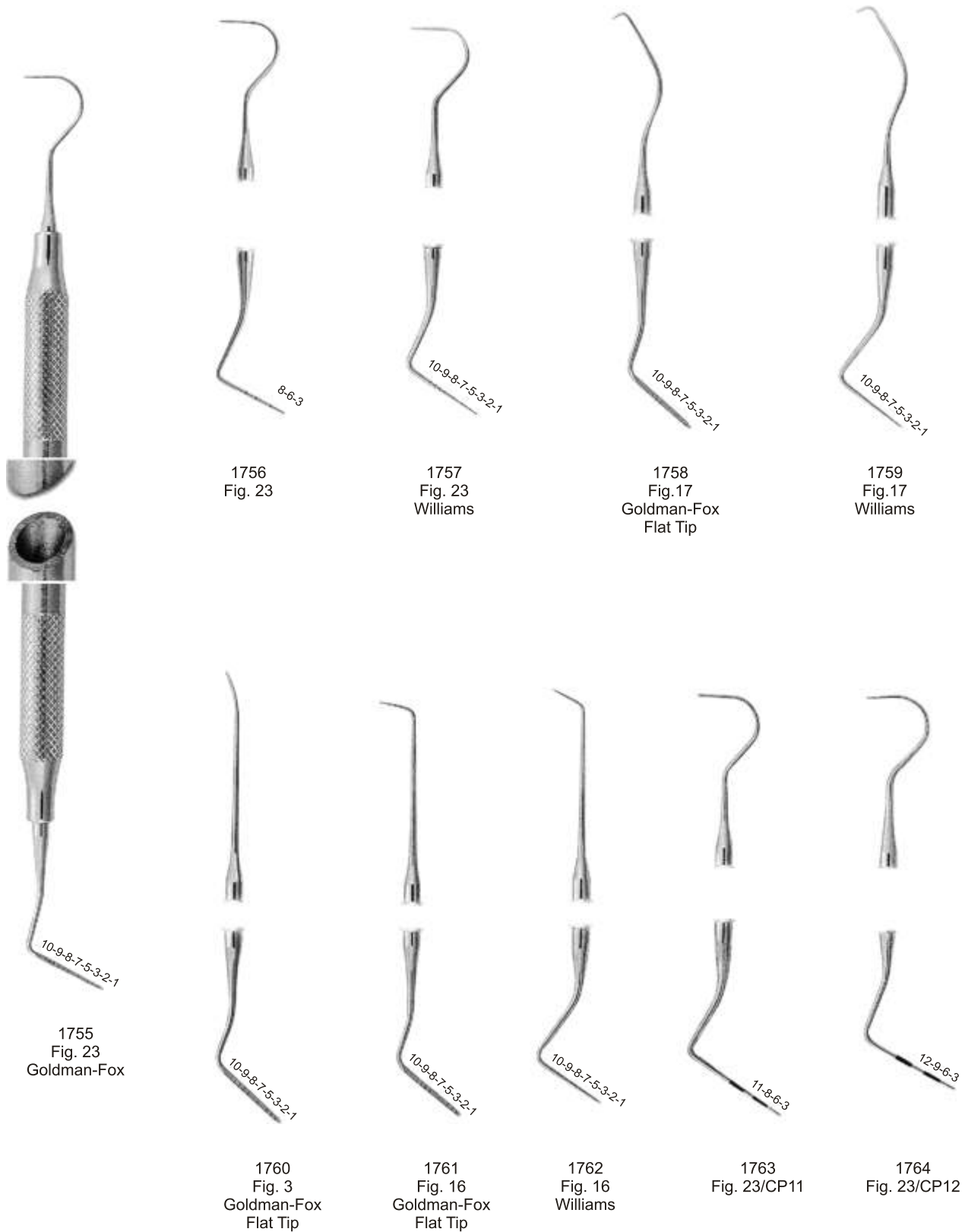



1765
Fig. 1
Spreader

1766
Fig. 2
Spreader

1767
Fig. 3
Spreader

1768
Fig. 4
Spreader

1769
Fig. 5
Spreader

1770
Fig. 6
Spreader

1771
Fig. 7
Spreader

Root-canal Pluggers

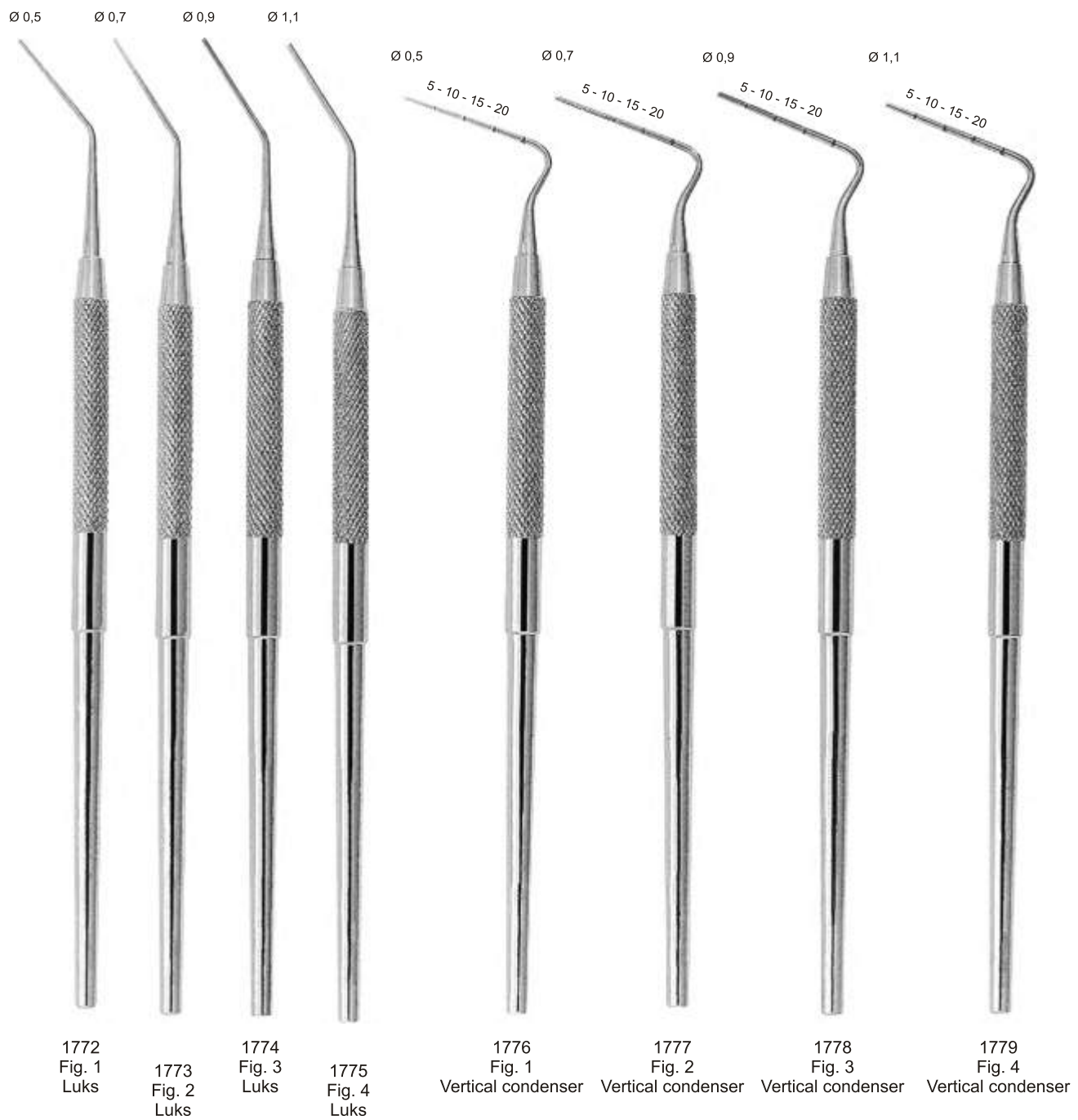

Root-canal explorers

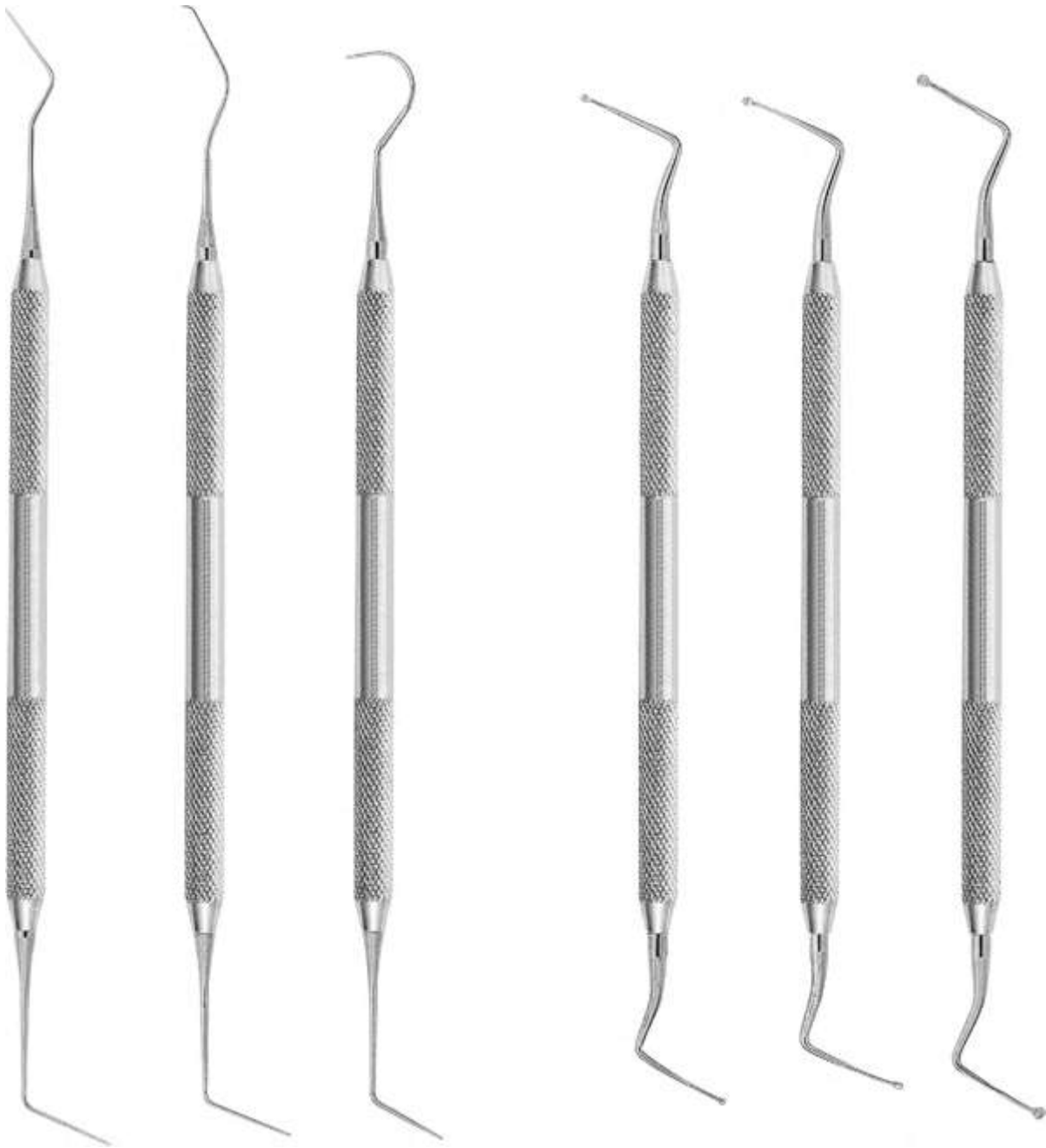

1780
Fig. 6/1

1781
Fig. 6/17

1782
Fig. 6/23

1783
Fig. 31L

1784
Fig. 32L

1785
Fig. 33L

ROOT-CANAL EXPLORERS



1786
Fig. 6/1

1787
Fig. 6/17

1788
Fig. 6/23

ROOT-CANAL EXCAVATORS

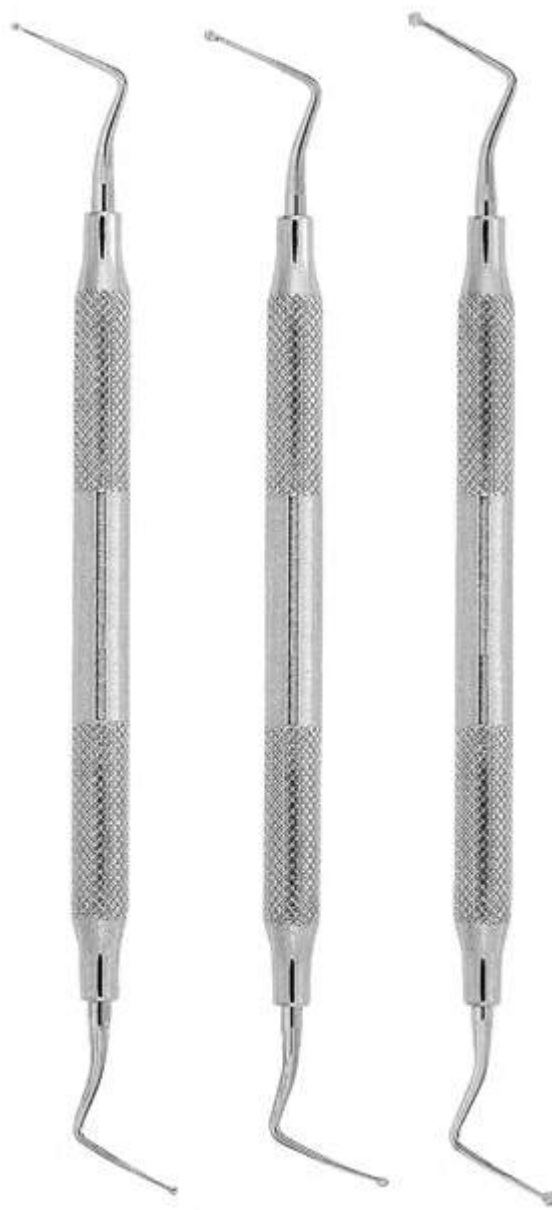

1789
Fig. 31L

1790
Fig. 32L

1791
Fig. 33L

ULTRALIGHT MIRROR



1792
cm. 16



Technical data:

2 batterie tipo AAA da 1,5 V
Consigliate quelle alcaline
n° 2 x 1,5 V alkaline
batties AAA type

Ricambi

- | | |
|------|--------------------|
| 1793 | O-Ring |
| 1794 | Lamp |
| 1795 | Spring |
| 1796 | Head with manaderl |

2 Alkaline Batteries.

Take out the batteries prior to sterilization.
Sterilizable O-ring on lamp to avoid penetration of saliva or liquid into the handle, thus preserving battery life.

Easy light on/off through bottom cap.

No mainrenance required for electrical or mechanical parts.

Full disassembly for proper cleaning.

Easy change of battries and lamps.

Ergonomic handle.

ULTRALIGHT RETRACTOR



1797
cm.15



Technical data:

2 batterie tipo AAA da 1,5 V consigliate quelle alcaline
n° 2x1.5 V alkaline batteries AAA Type

- | | |
|------|----------------------|
| 1798 | Ultralight Mirror |
| 1799 | Ultralight Retractor |
| 1800 | Locking Tray - Mini |



RUBBER DAM CLAMPS

PREMOLARS

ANTERIOR



Winged



1801
Fig. 9
Labial clamp

Winged



1802
Fig. 9T
Edged labial Clamp



Winged



1803
Fig. 212
Cervical clamp



Winged



1804
Fig. 210
Labial Clamp



1805
Fig. 00



1806
Fig. 0



1807
Fig. W0

For small teeth, elongated or with narrow collars



1808
Fig. 1



1809
Fig. 1T



1810
Fig. W1

For general use with adjustable jaws according to gingival line shapes



1811
Fig. 2A



1812
Fig. 2AT



1813
Fig. W2A

For premolars, with elongated collar



1814
Fig. 2



1815
Fig. 2T



1816
Fig. W2

For lower premolars with elongated collar



1817
Fig. 29



1818
Fig. 60

Primarily for lower premolars

MOLARS

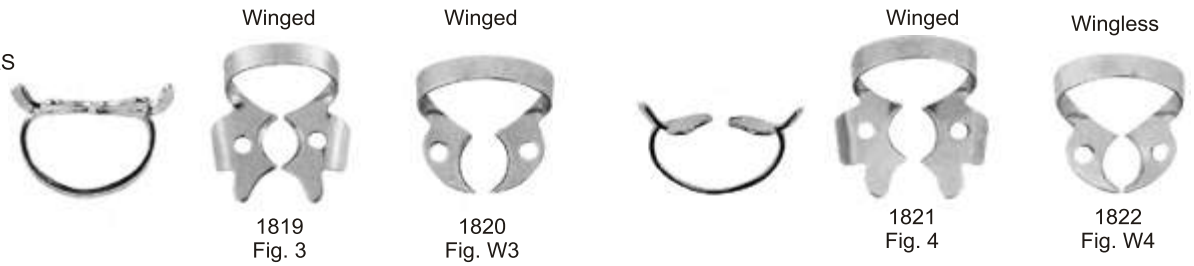

For small lower molars

For small molars with round collars



For square lower molars

For round upper molars

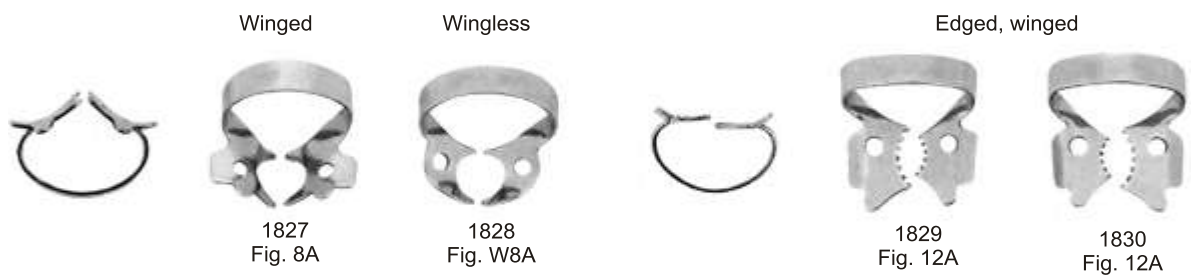

For molar roots

For partially broken molars

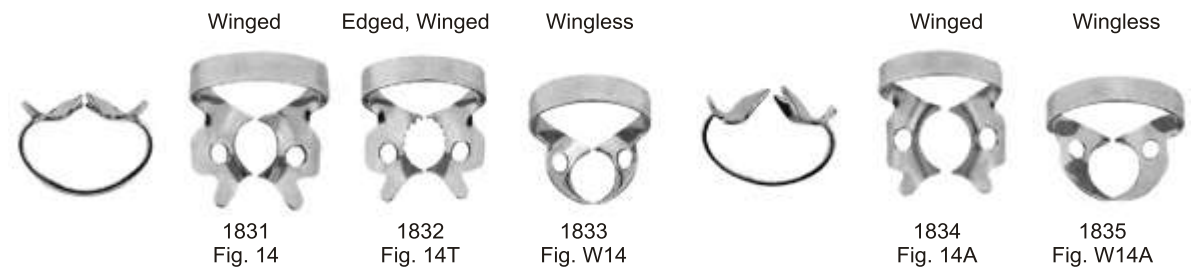

For round molars, partially broken, undersized or inclined



For upper molars

For big upper molars

RUBBER DAM CLAMPS



Band pusher

1840
Mershon
cm. 14



1841
Ainsworth
cm. 17

Punch Forceps



1842
Ivory
cm. 17

Clamp-forceps



1843
Ivory lightweight
cm.17



1844
Brewer
cm.17.5



1845
Stoke
cm.17.5

Latex dam vacuum packed. 36 pcs./pckg 15x15cm. Ready cut (6"x6")



1846

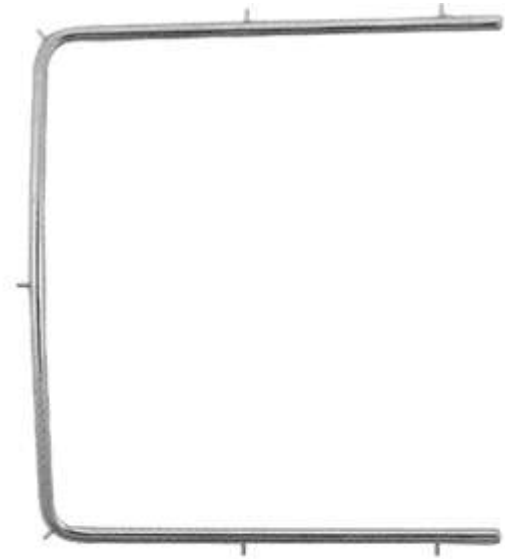

1847
cm. 10x10

Rubber dam frame - stainless steel

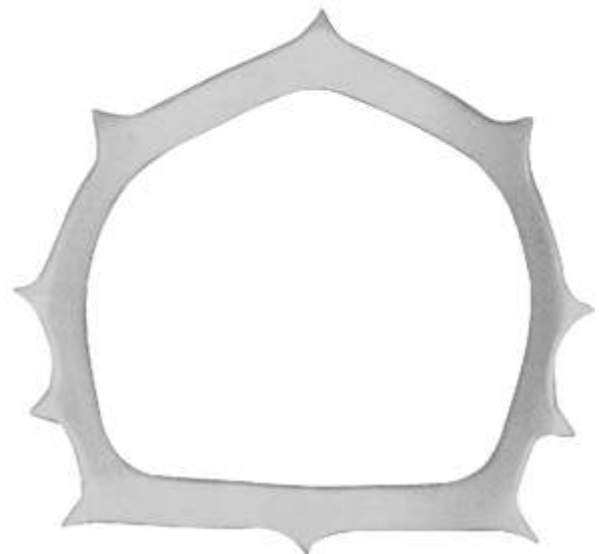

Doesn't need to be removed during x-rays.
Sterilizable.

1848

AMALGAM CARRIERS

Ø 1, 50mm

Ø 2, 50mm

Ø 3, 00mm

Ø 1, 50mm

Ø 2, 00mm

Ø 2, 50mm

Ø 3, 00mm

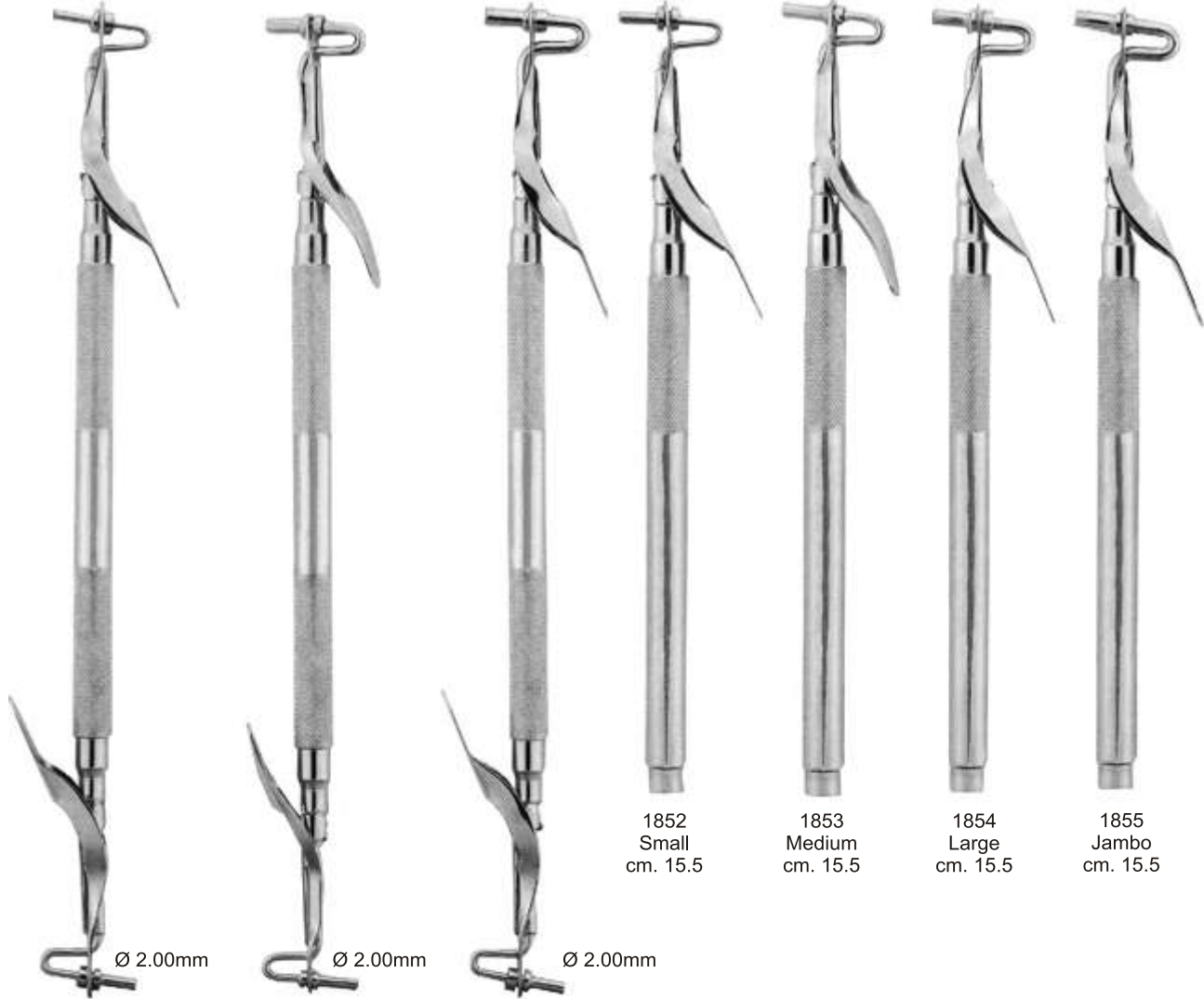

1849
Medium/Small
cm. 20

1850
Medium/Large
cm. 20

1851
Medium/Jumbo
cm. 20

1852
Small
cm. 15.5

1853
Medium
cm. 15.5

1854
Large
cm. 15.5

1855
Jumbo
cm. 15.5

AMALGAM WELLS



1856
Ø cm. 3.5
h.cm. 3.5



1857
Ø cm. 2
h.cm.4



1858
Ø cm. 2
h.cm.2.5

Autoclavable plastic amalgam carriers

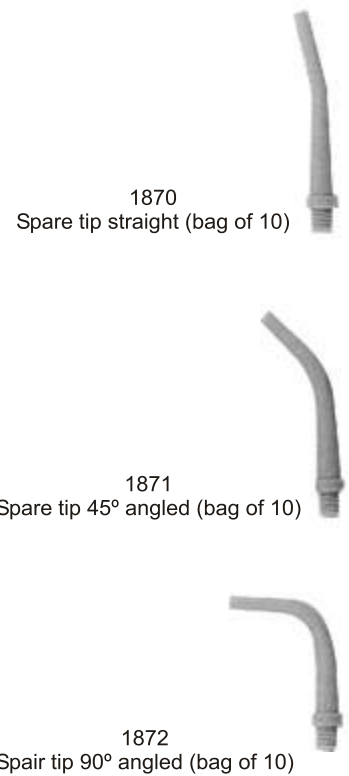
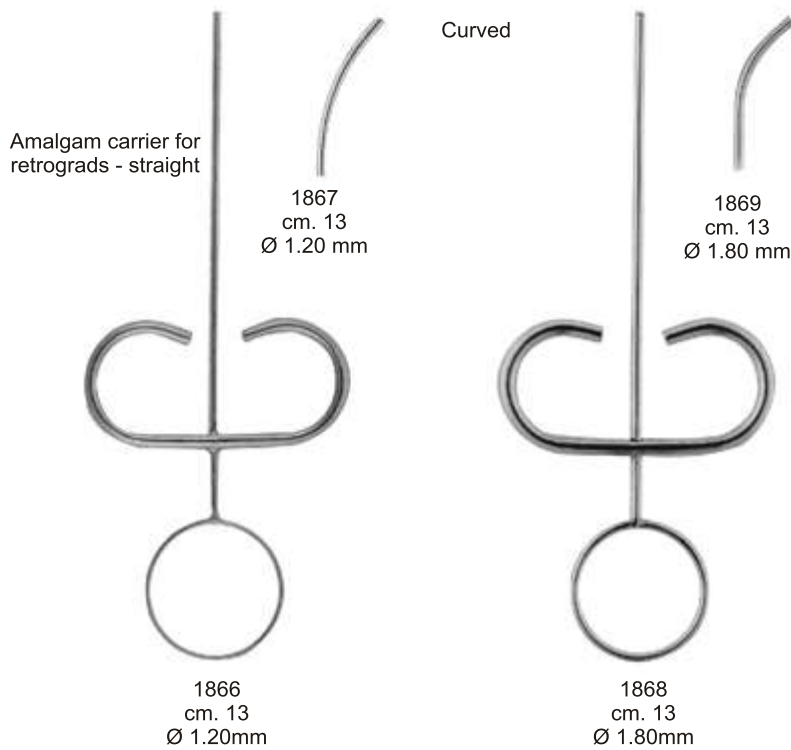

CEMENT SPATULAS

GLASS PLATE
1873
cm 8x12x0,5

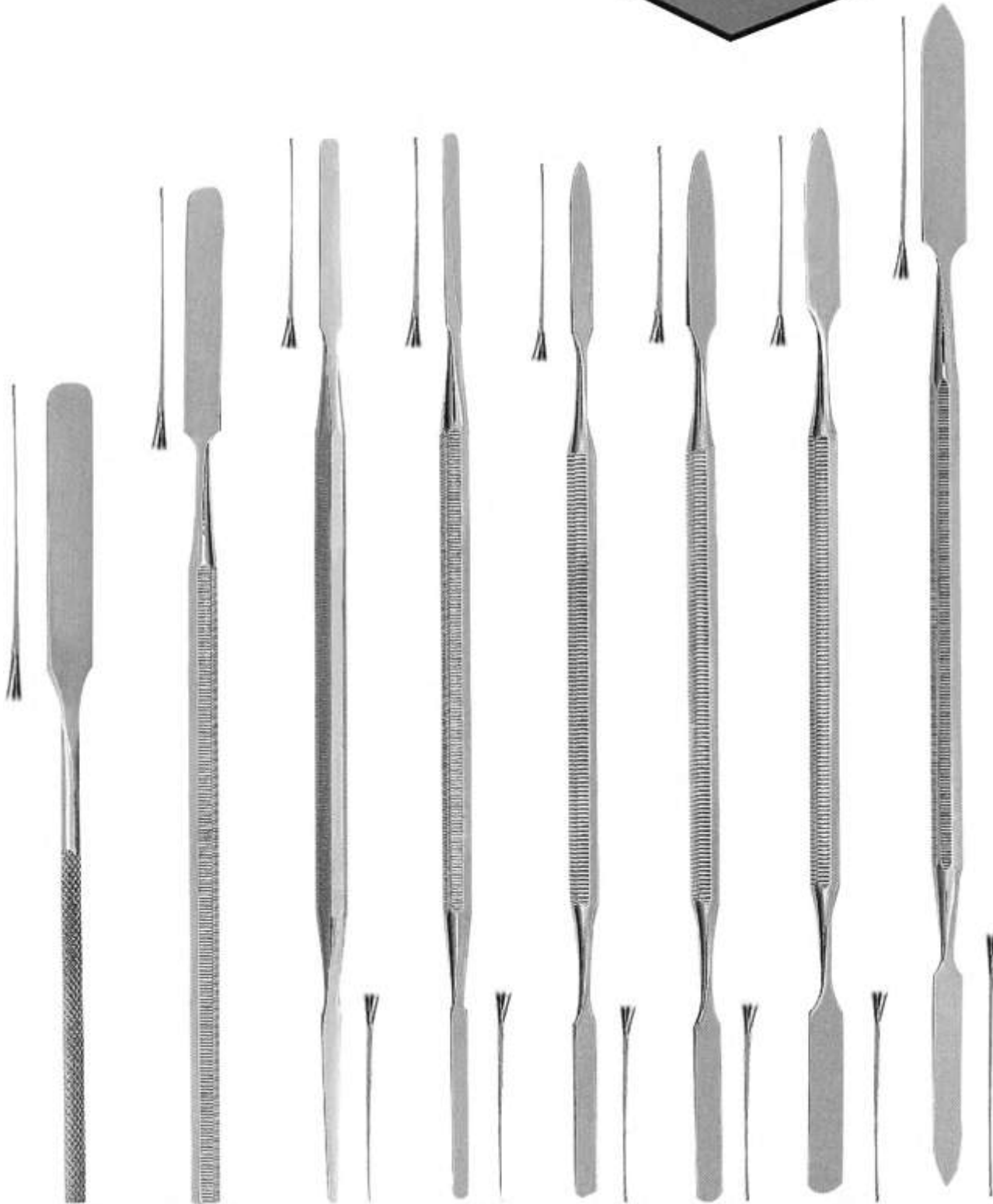

1874
Fig.1

1875
Fig.2

1876
Fig.00

1877
Fig.0

1878
Fig.1

1879
Fig.2

1880
Fig.3

1881
Fig.4

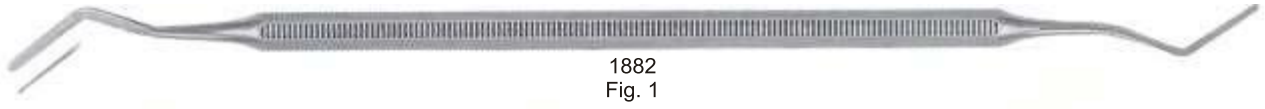

1882
Fig. 1



1883
Fig. 2

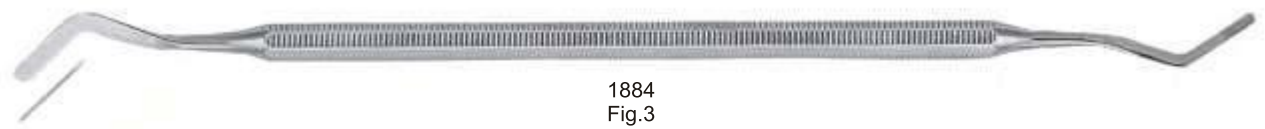

1884
Fig. 3



1885
Fig. 1



1886
Fig. 2



1887
Fig. 3

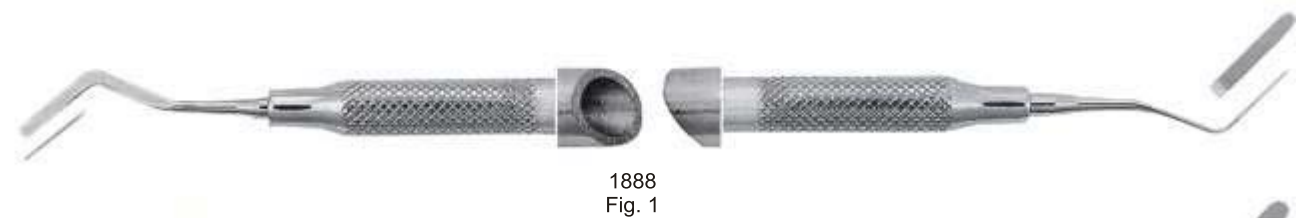

1888
Fig. 1

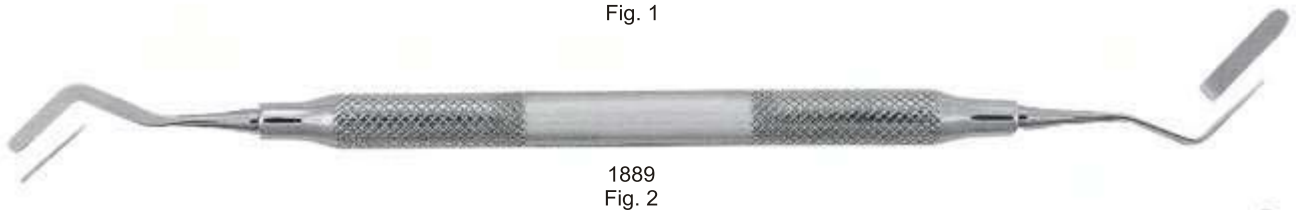

1889
Fig. 2



1890
Fig. 3

FILLING INSTRUMENTS

Amalgam instruments

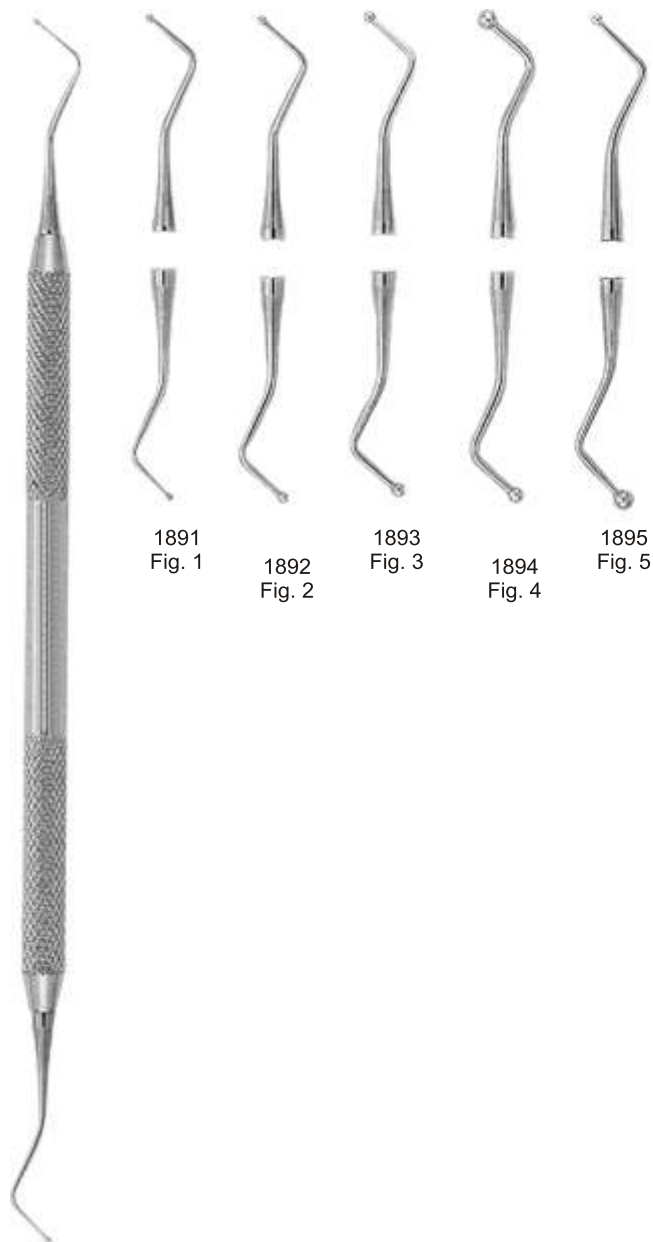

1891
Fig. 1

1892
Fig. 2

1893
Fig. 3

1894
Fig. 4

1895
Fig. 5

Serrated

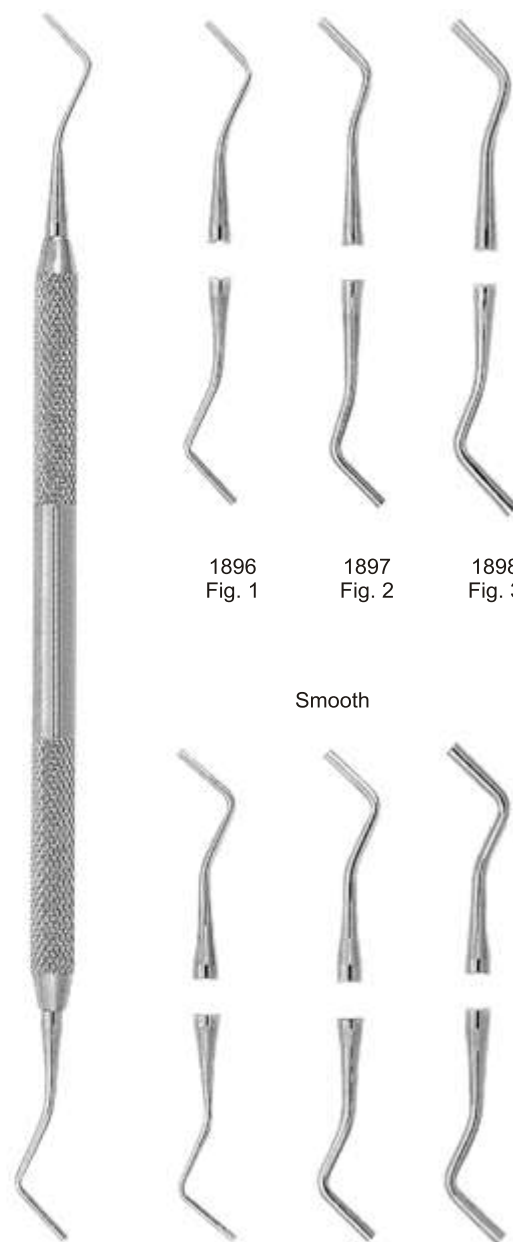

1896
Fig. 1

1897
Fig. 2

1898
Fig. 3

Smooth



1899
Fig. 1L

1900
Fig. 2L

1901
Fig. 3L

Serrated

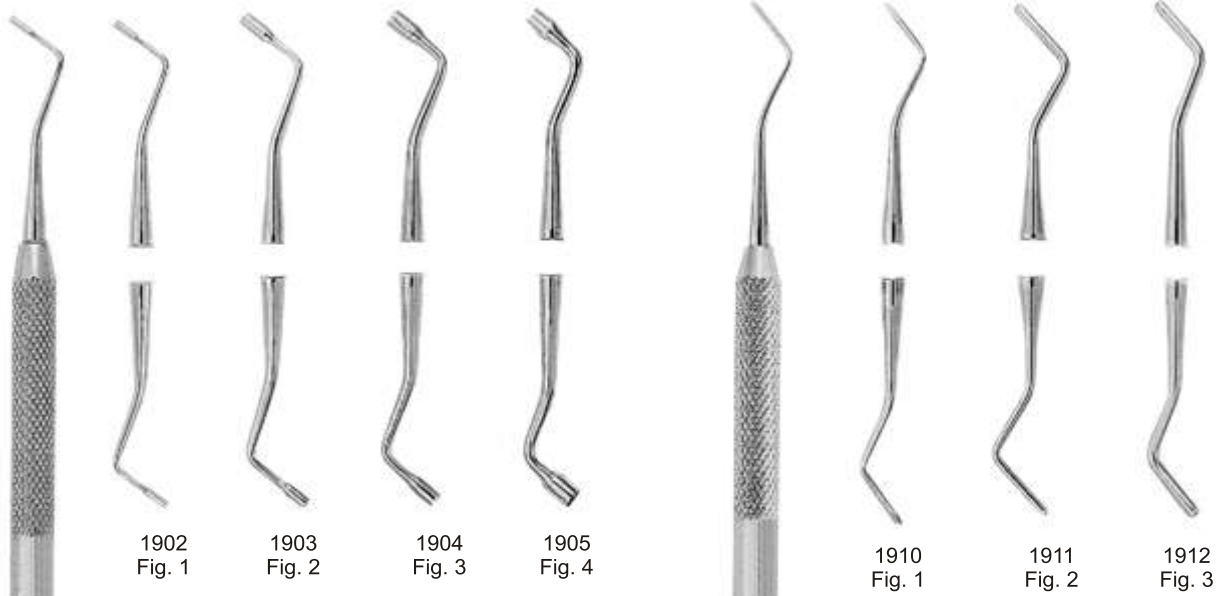

Smooth

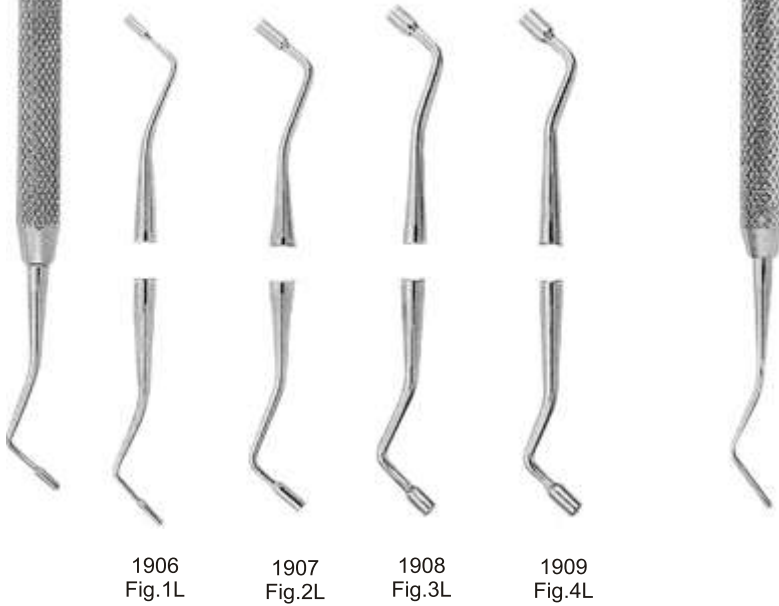

FILLING INSTRUMENTS

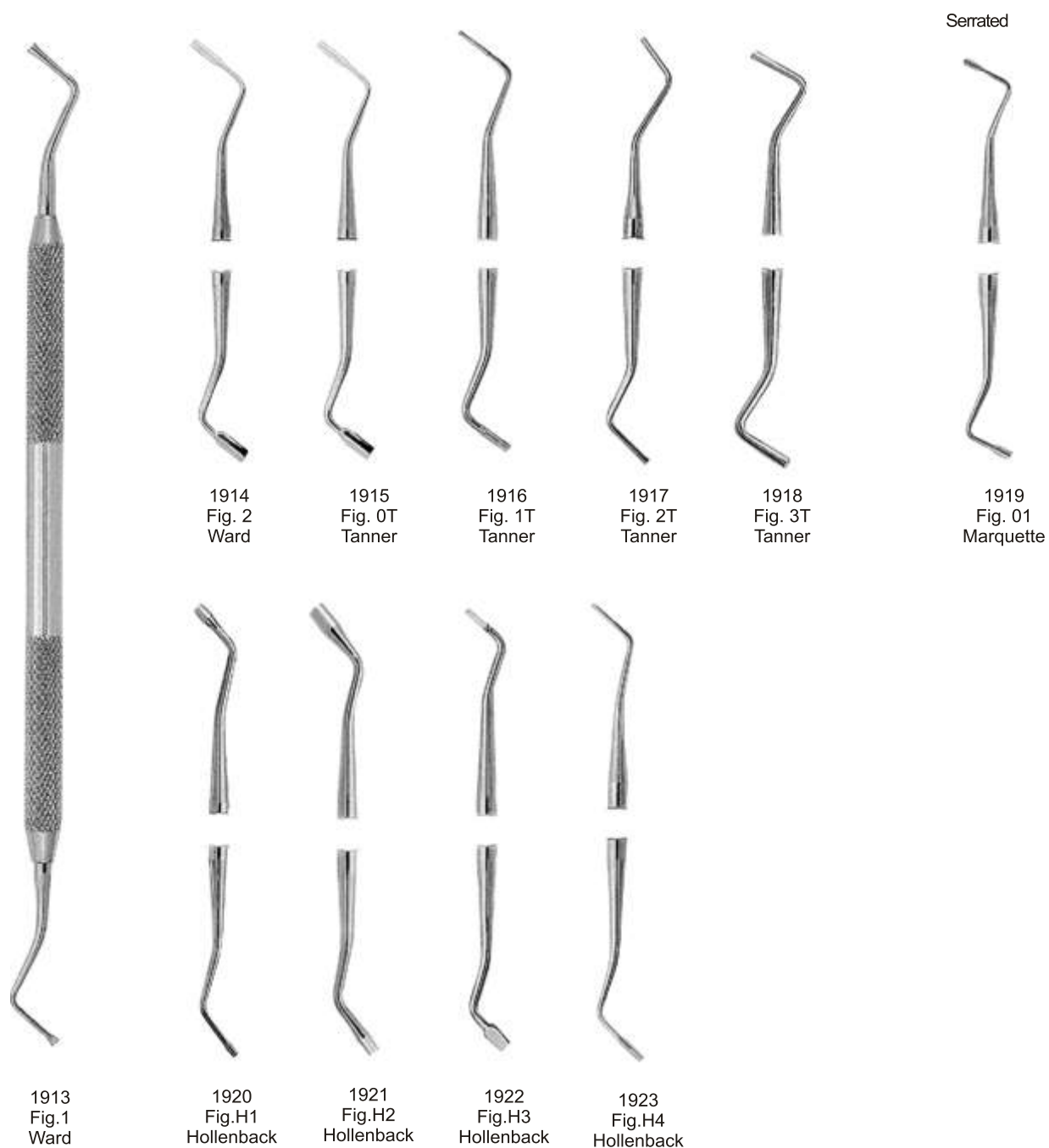

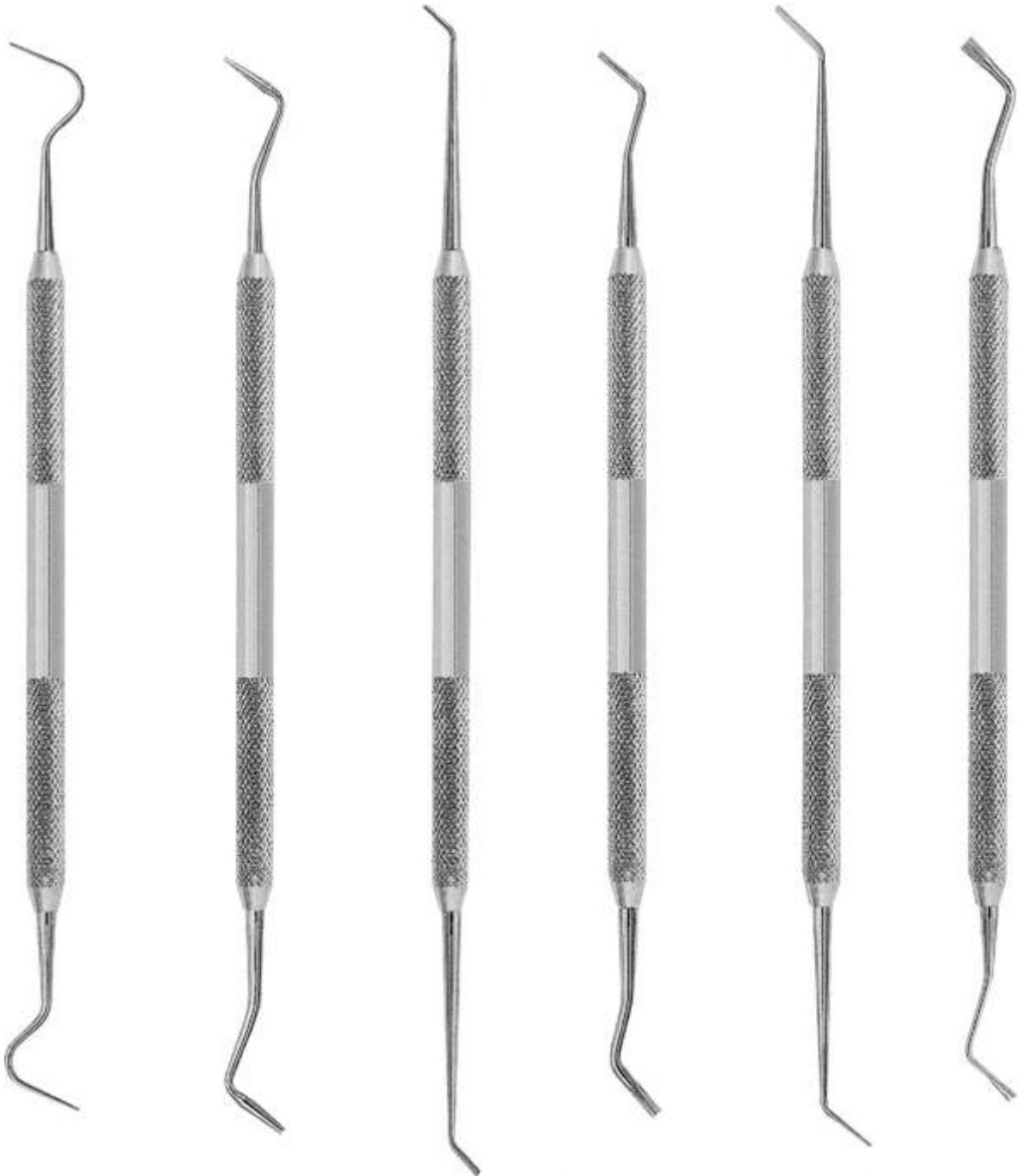

1924
Fig. 1
Markley

1925
Fig. 2
Markley

1926
Fig. 3
Markley

1927
Fig. 4
Markley

1928
Fig. 5
Markley

1929
Fig. 6
Markley

FILLING INSTRUMENTS

Foc Amalgam Instruments

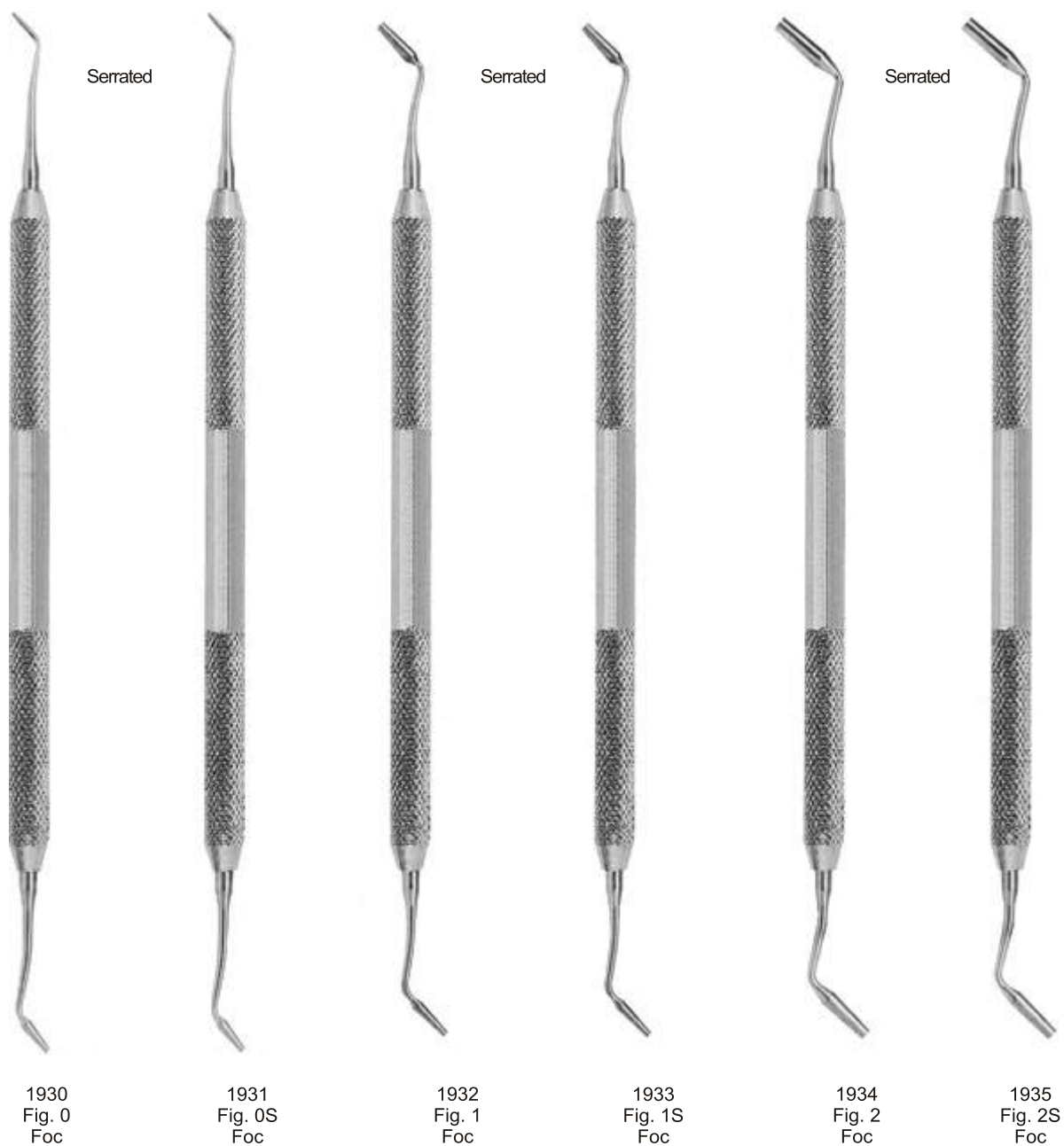



1936
Fig. 0
Foc

Serrated



1937
Fig. 0S
Foc



1938
Fig. 1
Foc

Serrated



1939
Fig. 1S
Foc



1940
Fig. 2
Foc

Serrated



1941
Fig. 2S
Foc

FILLING INSTRUMENTS

Burnishers

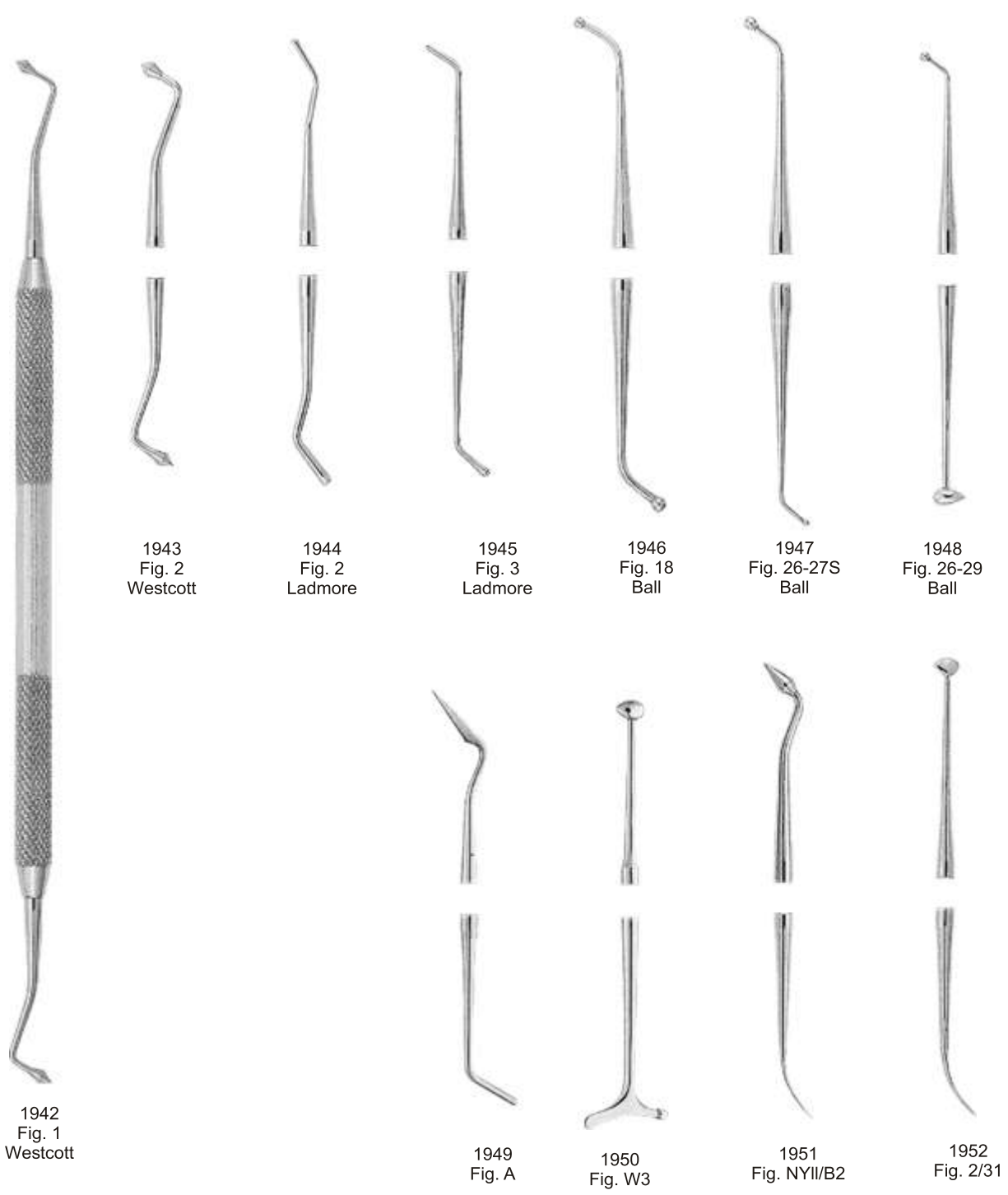

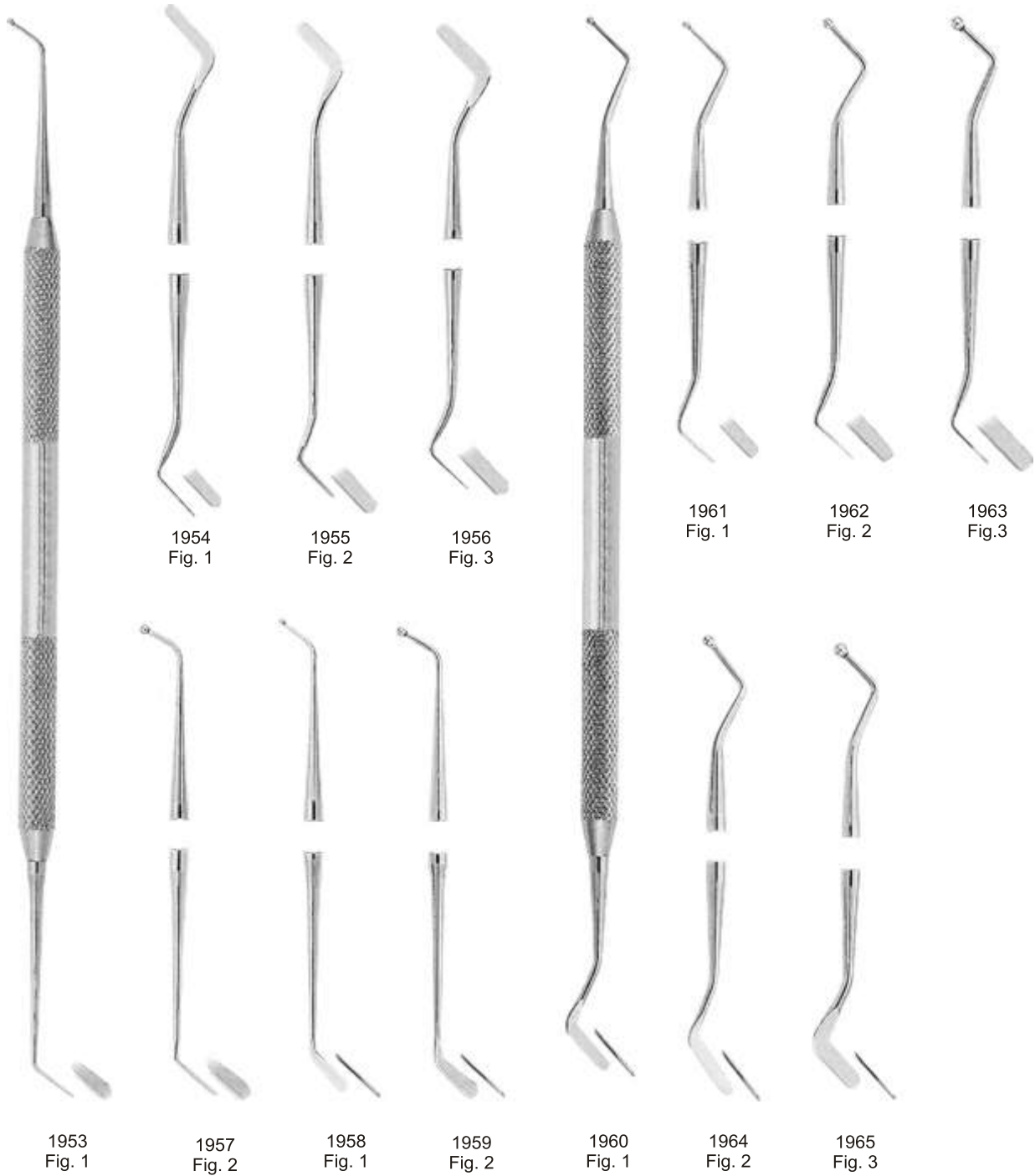

AMALGAM CARVES

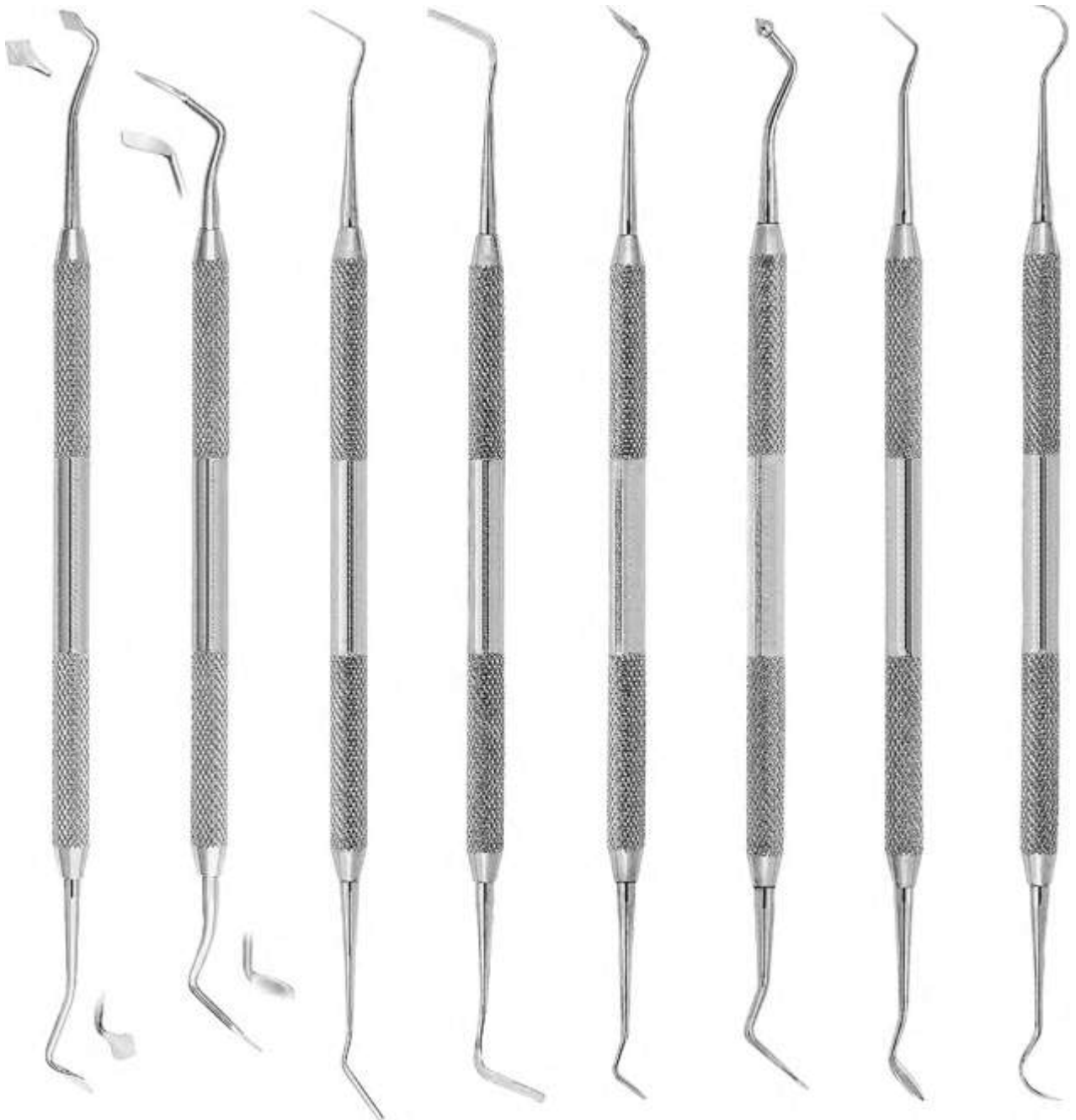

1966
Fig. 1
Frahm

1967
Fig. 2
USC

1968
Fig. 1
Interproximal

1969
Fig. 2
Interproximal
Off-Angle

1970
Fig. SHO-A

1971
Fig. 3-SHO

1972
Fig. 104

1973
Fig. 8
Wiland

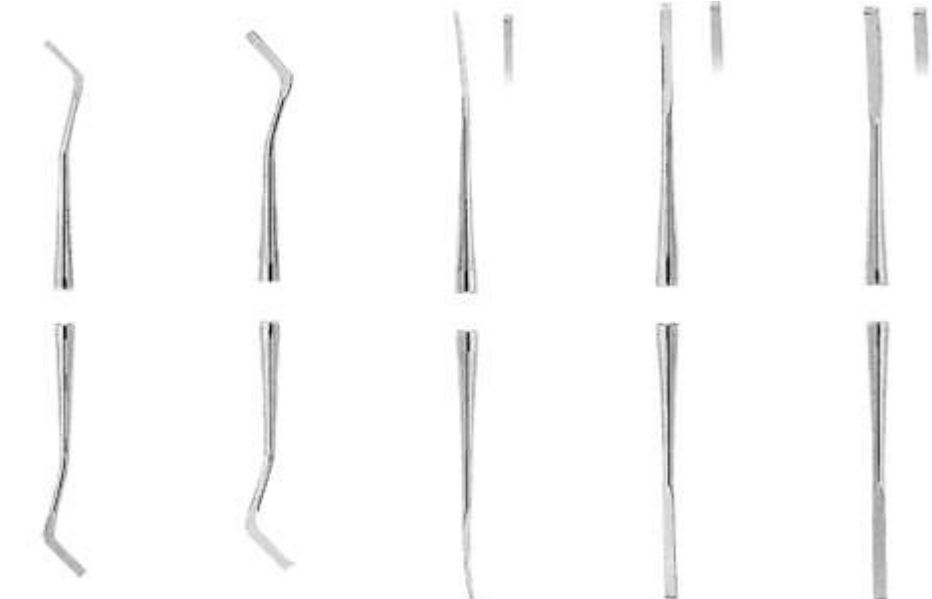

1975
Fig. 1
Black/53-54

1976
Fig. 2
Black/51-52

1977
Fig. 1 /2
Wedelstaet

1978
Fig. 3/4
Wedelstaet

1979
Fig. 5/6
Wedelstaet

Gingival margin trimmers



1974
Fig. 1
Black/26
Distal

1980
Fig. 2
Black/27
Mesial

1981
Fig. 3
Black/28
Distal

1982
Fig. 4
Black/29
Mesial

1983
Fig. 1
Black/77-78
Distal

1984
Fig. 2
Black/79-80
Mesial

EXCAVATORS

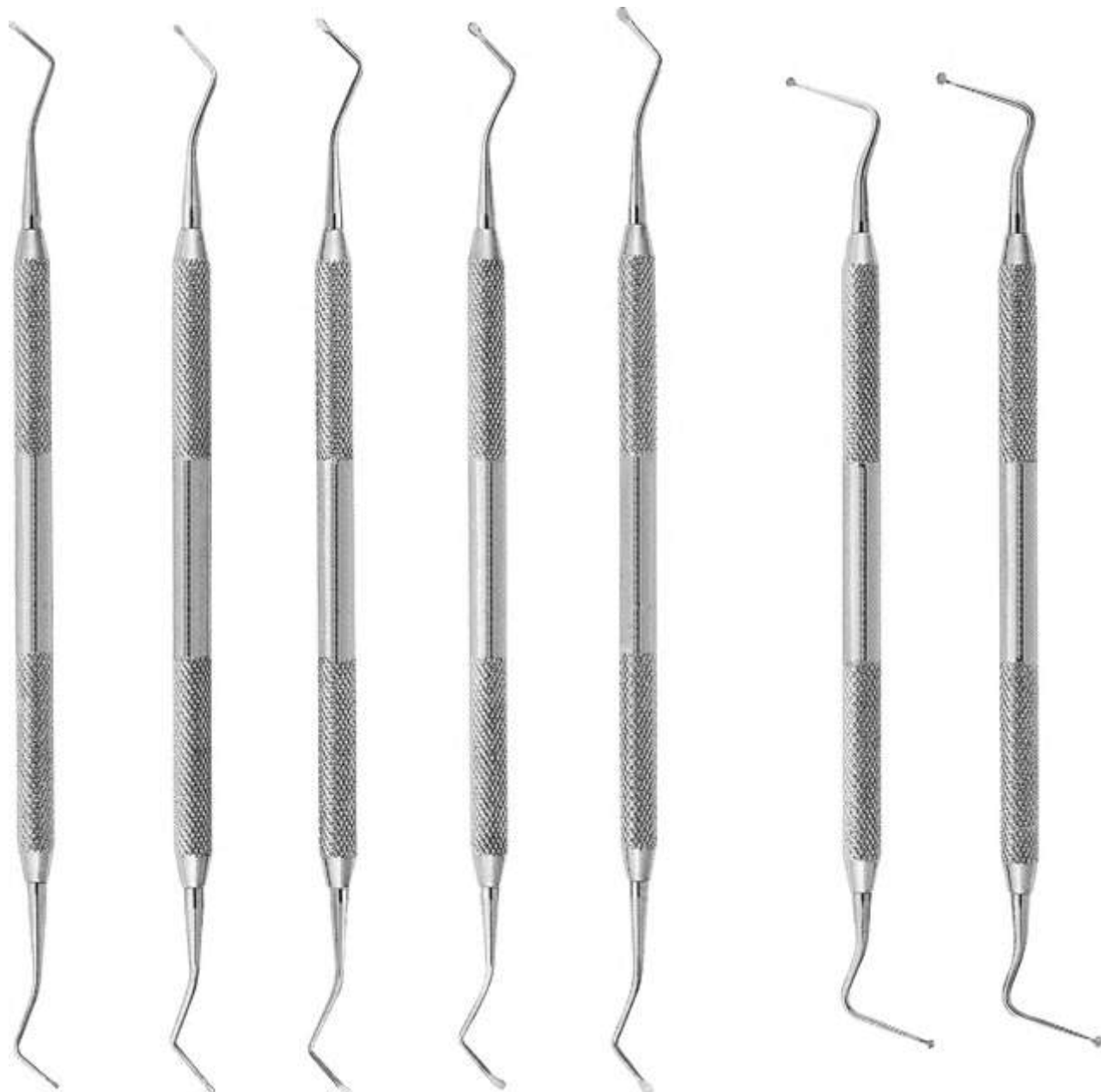

1985
Fig. 0

1986
Fig. 1

1987
Fig. 2

1988
Fig. 3

1989
Fig. 4

1990
Fig. 1

1991
Fig. 2



1992
Fig. 6



2000
Fig. 38/39

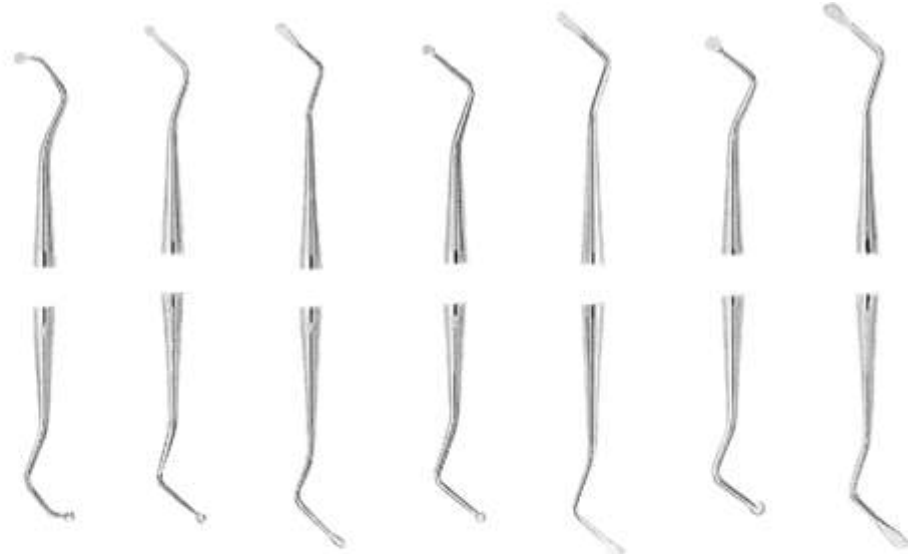

1993
Fig. 14

1994
Fig. 17

1995
Fig. 17W
Oval Spoon

1996
Fig. 18

1997
Fig. 18W
Oval spoon

1998
Fig. 19

1999
Fig. 19W
Oval spoon

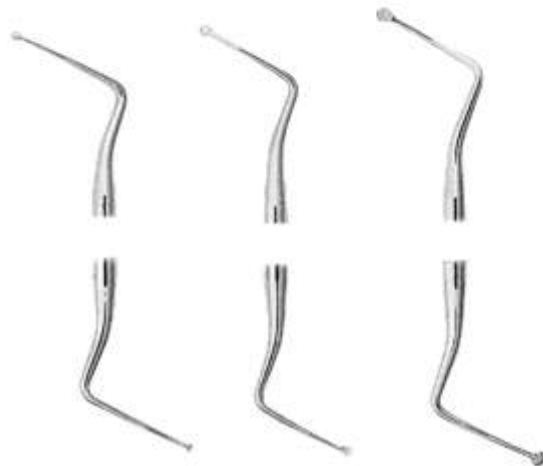

2001
Fig. 31L

2002
Fig. 32L

2003
Fig. 33L

EXCAVATORS

SS. White type

GLOMED
INSTRUMENTS

1 mm



2004
Fig. 5

1.2 mm



2005
Fig. 14

1 mm



2006
Fig. 17

1.2 mm



2007
Fig. 18

1.6 mm



2008
Fig. 19

2 mm



2009
Fig. 20

1 mm



2010
Fig. 243
ASH

1,4 mm



2016
Fig. G2
ASH

0,8 mm



2011
Fig. 1
Darby-Perry

0,8 mm



2012
Fig. 2
Darby-Perry

1 mm



2013
Fig. 11
Darby-Perry

1 mm



2014
Fig. 12
Darby-Perry

1,2 mm



2015
Fig. 21
Darby-Perry

1,2 mm



2017
Fig. 22
Darby-Perry

1,6 mm



2018
Fig. 31
Darby-Perry

1,6 mm



2019
Fig. 32
Darby-Perry

2 mm



2020
Fig. 41
Darby-Perry

2 mm



2021
Fig. 42
Darby-Perry

EXCAVATORS

SS. White type

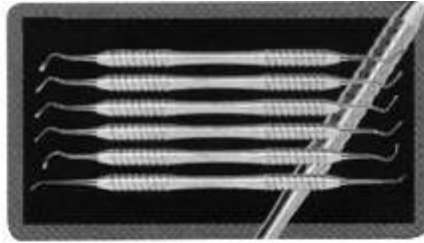

Set - 2022
Set of 6

1 mm



2023
Fig.5

1,2 mm



2024
Fig.4

1 mm



2025
Fig.17

1,2 mm



2026
Fig.18

1,6 mm



2027
Fig.19

2 mm



2028
Fig.20

1 mm



2029
Fig. 243
ASH

1,4 mm



2035
Fig. G2
ASH

0,8 mm



2030
Fig. 1
Darby-Perry

0,8 mm



2031
Fig. 2
Darby-Perry

1 mm



2032
Fig. 11
Darby-Perry

1 mm



2033
Fig. 12
Darby-Perry

1,2 mm



2034
Fig. 21
Darby-Perry

1,2 mm



2036
Fig. 22
Darby-Perry

1,6 mm



2037
Fig. 31
Darby-Perry

1,6 mm



2038
Fig. 32
Darby-Perry

2 mm



2039
Fig. 41
Darby-Perry

2 mm



2040
Fig. 42
Darby-Perry

Crown removers

Complete with 3 attachments



2042

2043

2044

Attachments

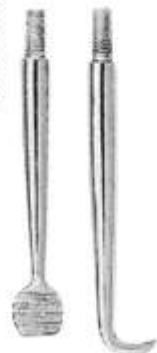

2041



2045

Crown Spreader, Crown Remover.
Special instrument for crown spreading after separating, simple and safe operation.

Complete with 2 attachments



2047

2048

Attachments

2046

2049

DECIMAL CALIPER

2051
For wax



2052
For metal

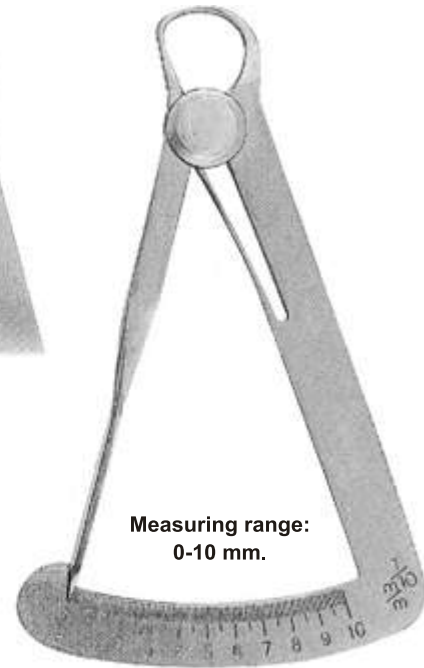

Measuring range:
0-10 mm.

Iwanson



2050
Boley
cm. 14

Measuring range 0-100 mm.

Copper rings removing pliers

Straight



2053
Furrer
cm. 16

Curved



2054
Furrer
cm. 16

Crown spreaders



2056
Fig. 1



2057
Fig. 2



2055
Fig. 0



2058
Fig. 3
Universal



Articulating paper forceps



2059
Miller
cm. 15



2060
cm. 15

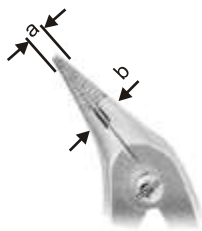

a 3,3mm
b 4mm

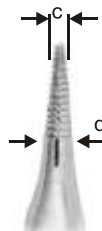

c 2,3 mm
d 3,0 mm

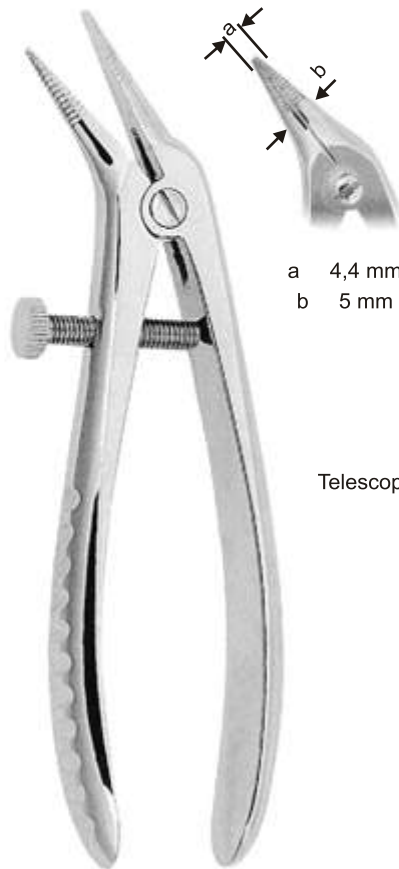

2061
cm. 11,5

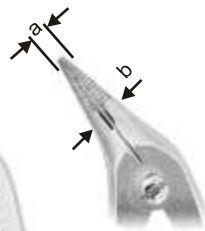

a 4,4 mm
b 5 mm



c 3,4 mm
d 3,8mm

Telescope Crown Pliers



2062
cm. 14,5



Straight

2063
Fig. 1
Kelly
cm. 14



Straight

2064
Fig. 1
Halstead-Mosquito
cm. 12



Straight

2065
Fig. 1
Micro-Mosquito
cm. 10

MATRIX RETAINERS



2066
Fig. 5
Ivory 8
mm 5



2067
Fig. 6
Ivory 8
mm 6



2068
Fig. 7
Ivory 8
mm 7



2069
Ivory 8 N



2070
Didner 8 P



2071
Fig. 1
Tofflemire-Universal



2072
Fig. 2
Tofflemire-Junior



2073
Fig. 3
Tofflemire-Senior



2074
mm. 6x cm.100



2075
mm. 5x cm. 100

For matrix retainers:



2076
mm. 7x cm.100

Assorted in Package of 12



2077
Tofflemire

12 Each for Package



2078
Fig. 1
Tofflemire



2079
Fig. 2
Tofflemire



2080
Fig. 3
Tofflemire

PERIODONRAL INSTRUMENTS

Bone chisels and gouges



Partsch
cm.13,5

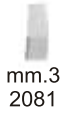

mm.3
2081



mm.4
2082



mm.5
2083



mm.6
2084



Partsch
cm.13,5



mm.3
2085



mm.4
2086



mm.5
2087



mm.6
2088



Partsch
cm.17



mm.3
2089



mm.4
2090



mm.5
2091



mm.6
2092



Partsch
cm.17



mm.3
2093



mm.4
2094



mm.5
2095



mm.6
2096

MALLETS



Lead filled

2097
Partsch
cm. 19



Plastic inserts
autoclavable max 140°

2098
Mead
cm. 19,5



With Interchangeable
Ferozell inserts

2099
Mead
cm. 17



2100
Vickers
cm. 19



2101
Herbert
cm. 19

PERIOSTEAL AND ELEVATORS



2102
Fig. 15
Freer

2103
Fig. 16
Freer

2104
König
cm. 15,5

2105
Parsch
cm. 14,5

2106
Fig. 22
Seldin retractor

2107
Fig. 23
Seldin retractor

2108
Williger
cm.17

2109
Williger
cm.16

2110
Williger
cm.16

2111
Williger
cm.13

BONE FILES

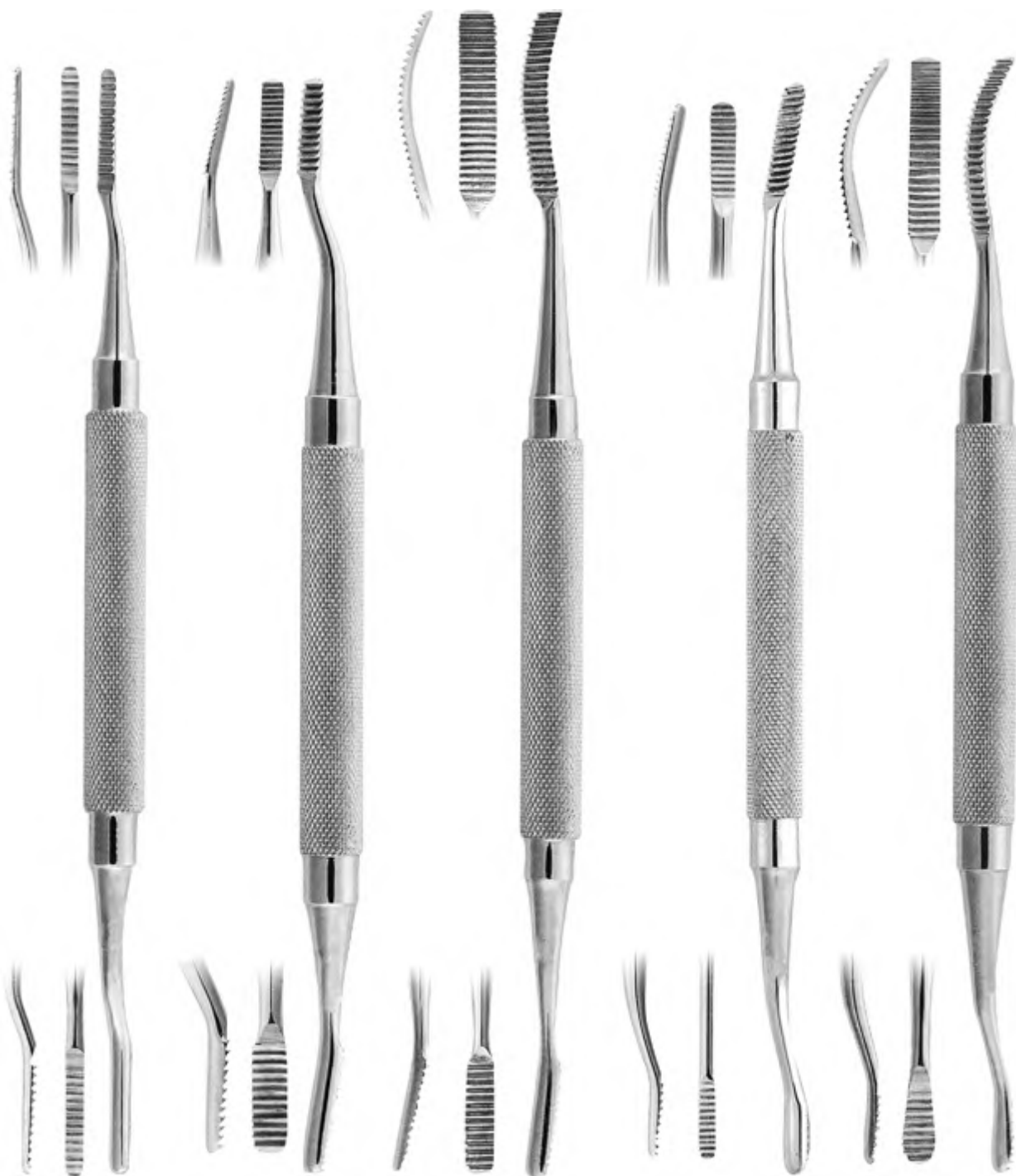

2112
Fig. 1
Polokoff

2113
Fig. 33

2114
Fig. 45
Miller

2115
Fig. 64
Miller

2116
cm. 10

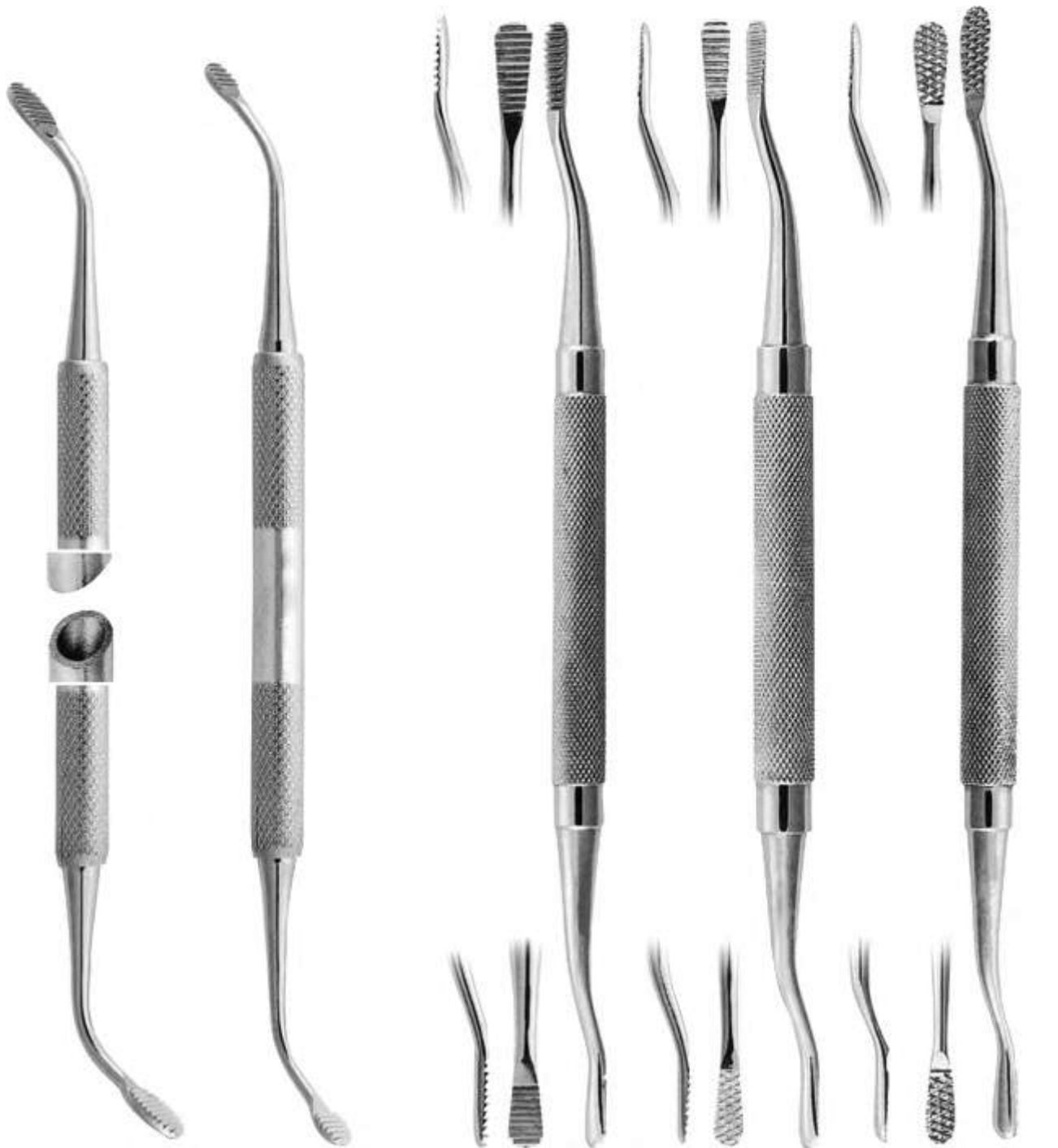

2117
Fig. 1
Wahl

2118
Fig. 2
Wahl

2119
Fig. 12
Howard

2120
Fig. 12A

2121
Fig. 12CA

PERIODONTAL INSTRUMENTS



Periodontal pocket markers



2123 Fig. 1 (Crane-Kaplan) Goldman-Fox cm. 15

2124 Fig. 2 (Crane-Kaplan) Goldman-Fox cm. 15

Small beaks for use in limited access areas



FILES



2127
Fig. 1S/2S
Sugarman

2128
Fig. 1S/4S
Sugarman

2129
Fig. 9/10
Schluger

CHISELS



2130
Fig. 3
Ochsenbein

2131
Fig. 4
Ochsenbein

2132
Fig. 36/37
Rhodes
Back-Action

CHISELS

GINGIVECTOMY KNIVES



2133
Fig. 1 /2
TG Chisel



2134
Fig. 1 /2
TG Chisel



2135
Fig. 1
TG Chisel



2136
Fig. 2
TG Chisel



2137
Fig. 1
(15K)
Kirkland



2138
Fig. 2
(16K)
Kirkland



2139
Fig. 1
Orban



2140
Fig. 2
Orban

GINGIVECTOMY KNIVES

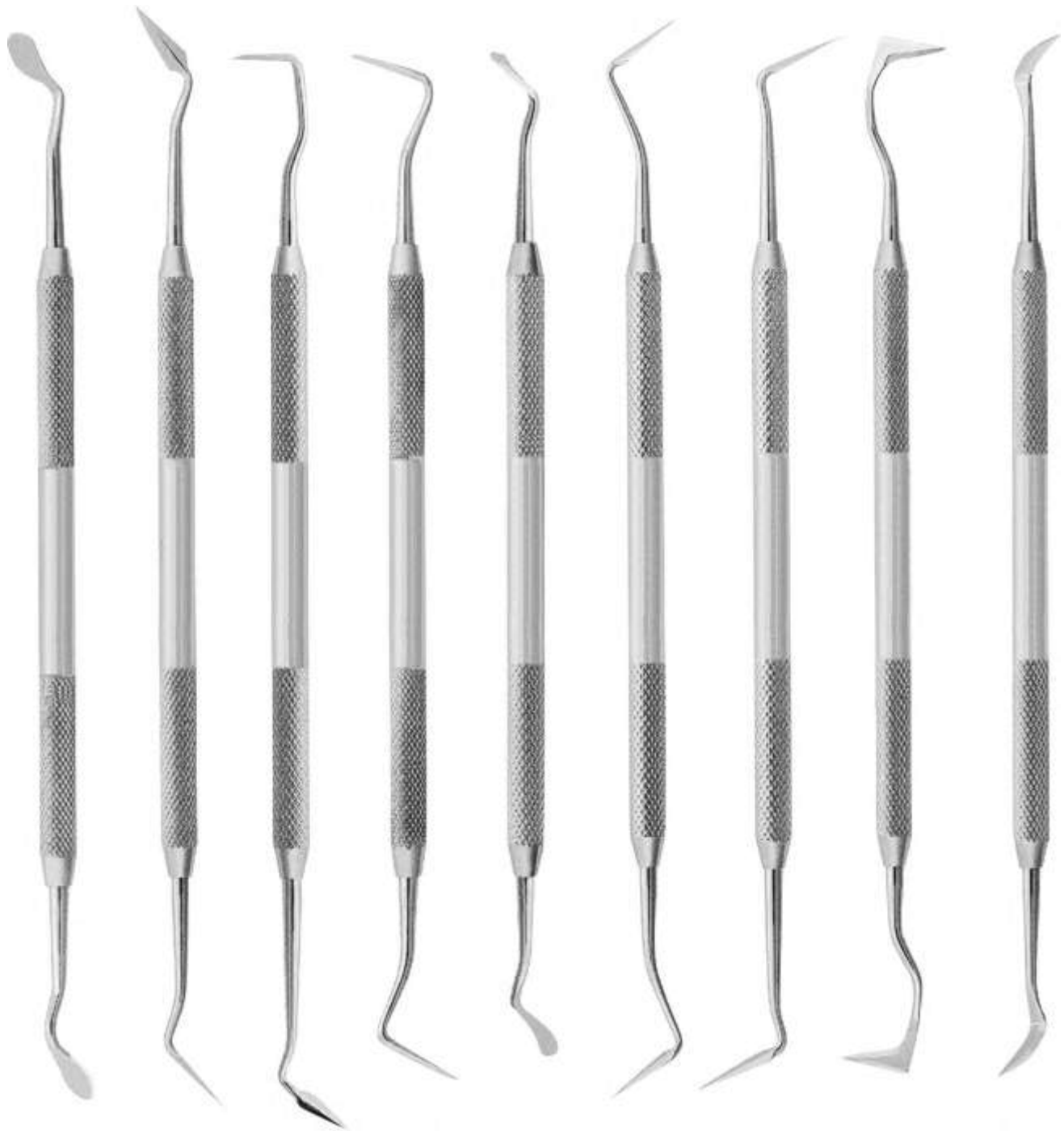

2141 Fig. 7 Goldman-Fox	2142 Fig. 8 Goldman-Fox	2143 Fig. 9 Goldman-Fox	2144 Fig. 11 Goldman-Fox	2145 Fig. 3/4 Buck	2146 Fig. 1/2 Sanders	2147 Fig. 4/5 Sanders	2148 Fig. 19/20	2149 Fig. Ck3 Crane-Kaplan
-------------------------------	-------------------------------	-------------------------------	--------------------------------	--------------------------	-----------------------------	-----------------------------	--------------------	----------------------------------

GRACEY CURRETTES AF TYPE

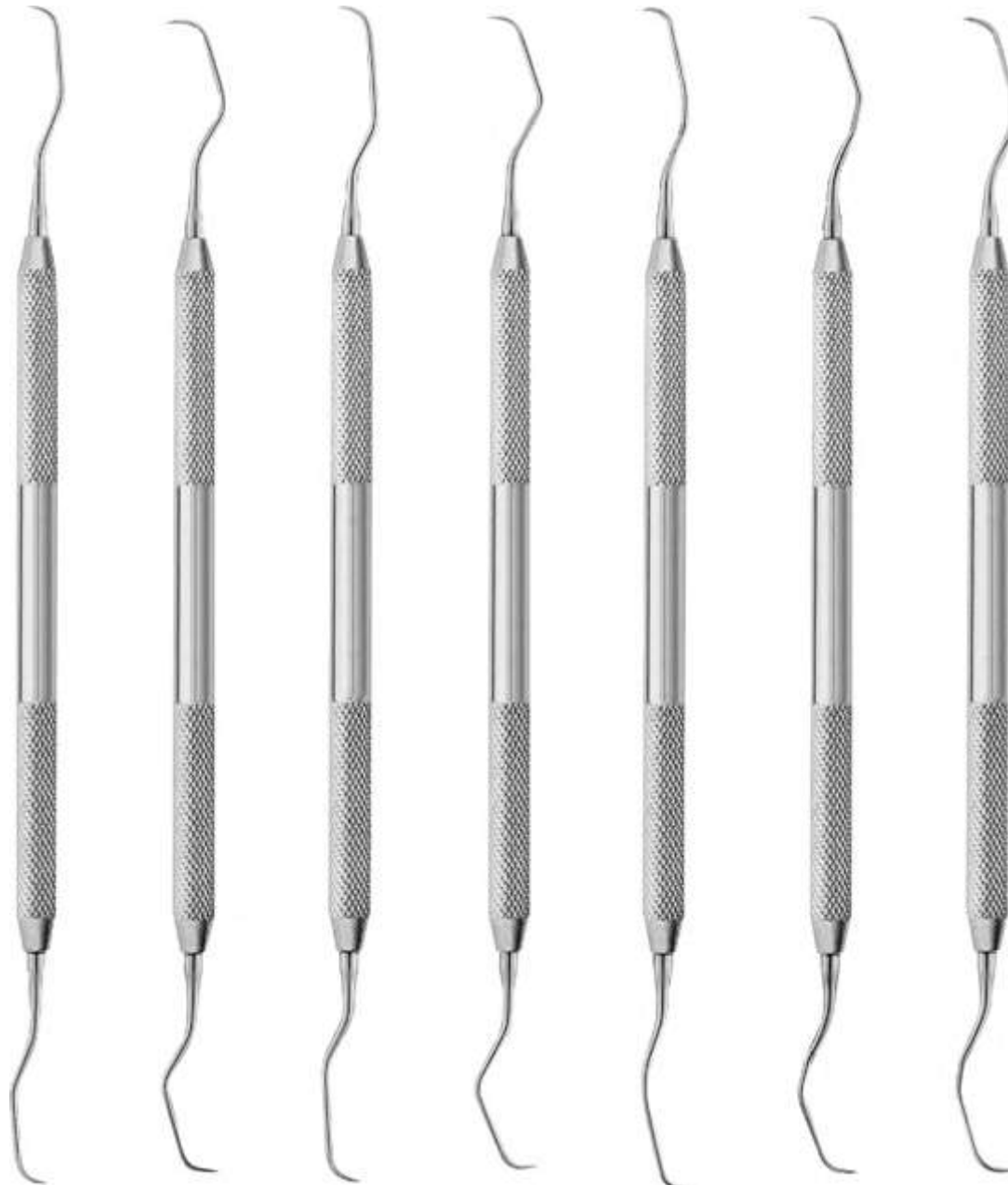

2150
Fig. 1/2
Gracey
AF / Type

2151
Fig. 3/4
Gracey
AF / Type

2152
Fig. 5/6
Gracey
AF / Type

2153
Fig. 7/8
Gracey
AF / Type

2154
Fig. 11/12
Gracey
AF / Type

2155
Fig. 13/14
Gracey
AF / Type

2156
Fig. 15/16
Gracey
AF / Type

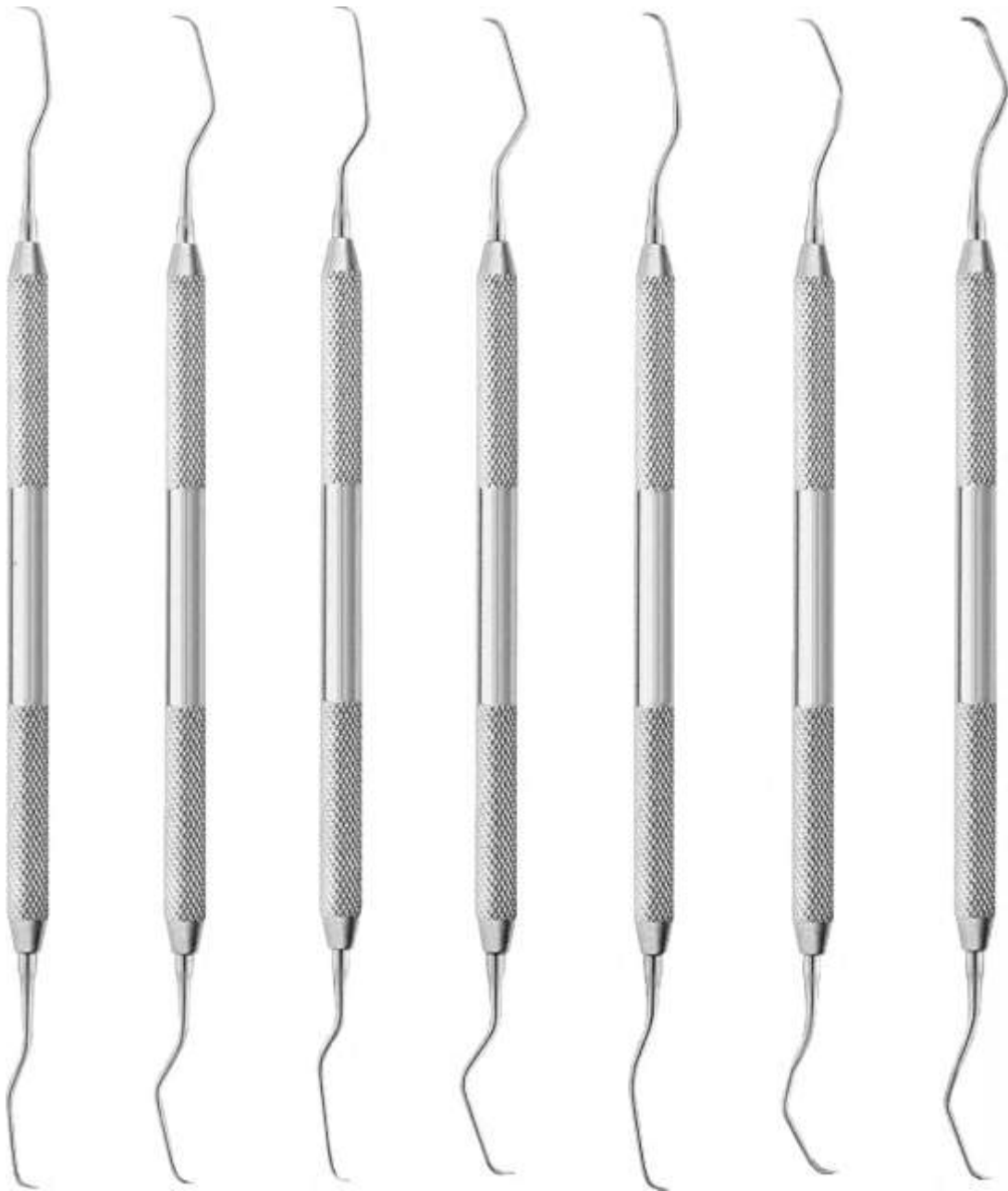

2157
Fig. 1/2
Gracey
MF / Type

2158
Fig. 3/4
Gracey
MF / Type

2159
Fig. 5/6
Gracey
MF / Type

2160
Fig. 7/8
Gracey
MF / Type

2161
Fig. 11/12
Gracey
MF / Type

2162
Fig. 13/14
Gracey
MF / Type

2163
Fig. 15/16
Gracey
MF / Type

CURETTES AND SCALERS

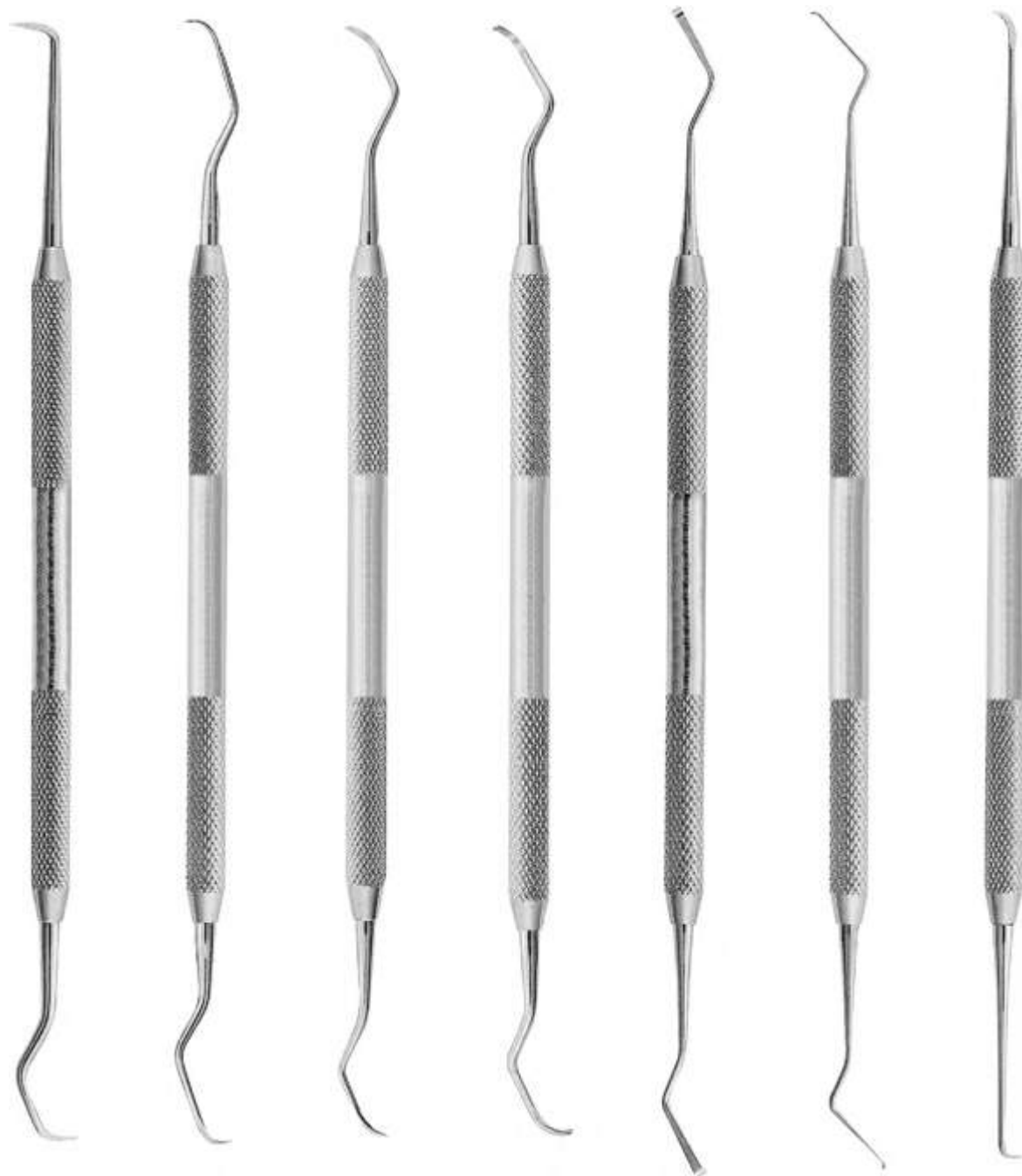

2164
Fig.1
Goldman-Fox

2165
Fig.2
Goldman-Fox

2166
Fig.3
Goldman-Fox

2167
Fig.4
Goldman-Fox

2168
Fig.5
Goldman-Fox

2169
Fig.6
Goldman-Fox

2170
Fig.21
Goldman-Fox

CURETTES AND SCALERS

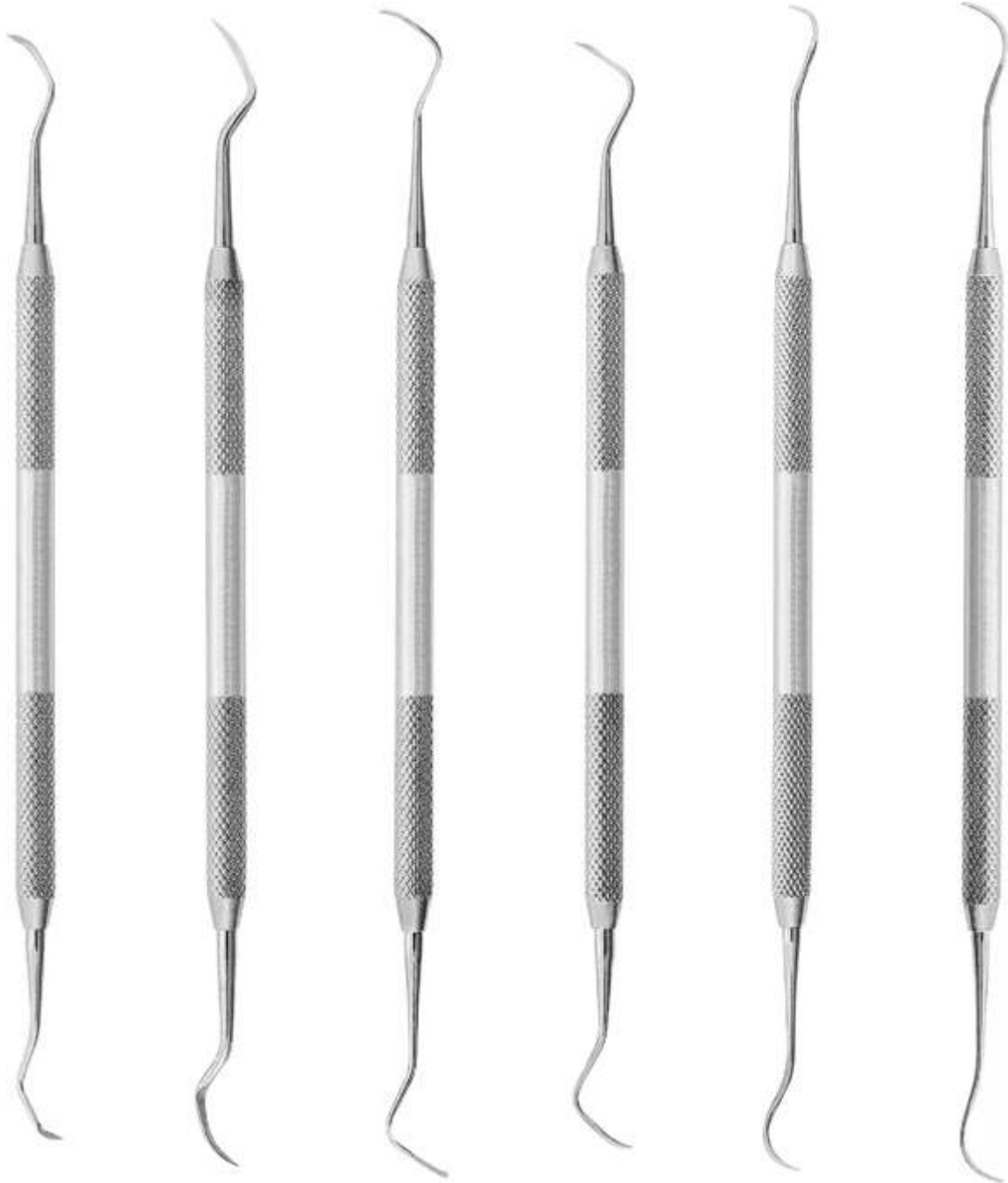

2171
Fig. 11/12
Mc Call

2172
Fig. 11A/12A
Mc Call

2173
Fig. 13/14
Mc Call

2174
Fig. 13S/14S
Mc Call

2175
Mc Call

2176
Fig. 19/20
Mc Call

CURETTES AND SCALERS

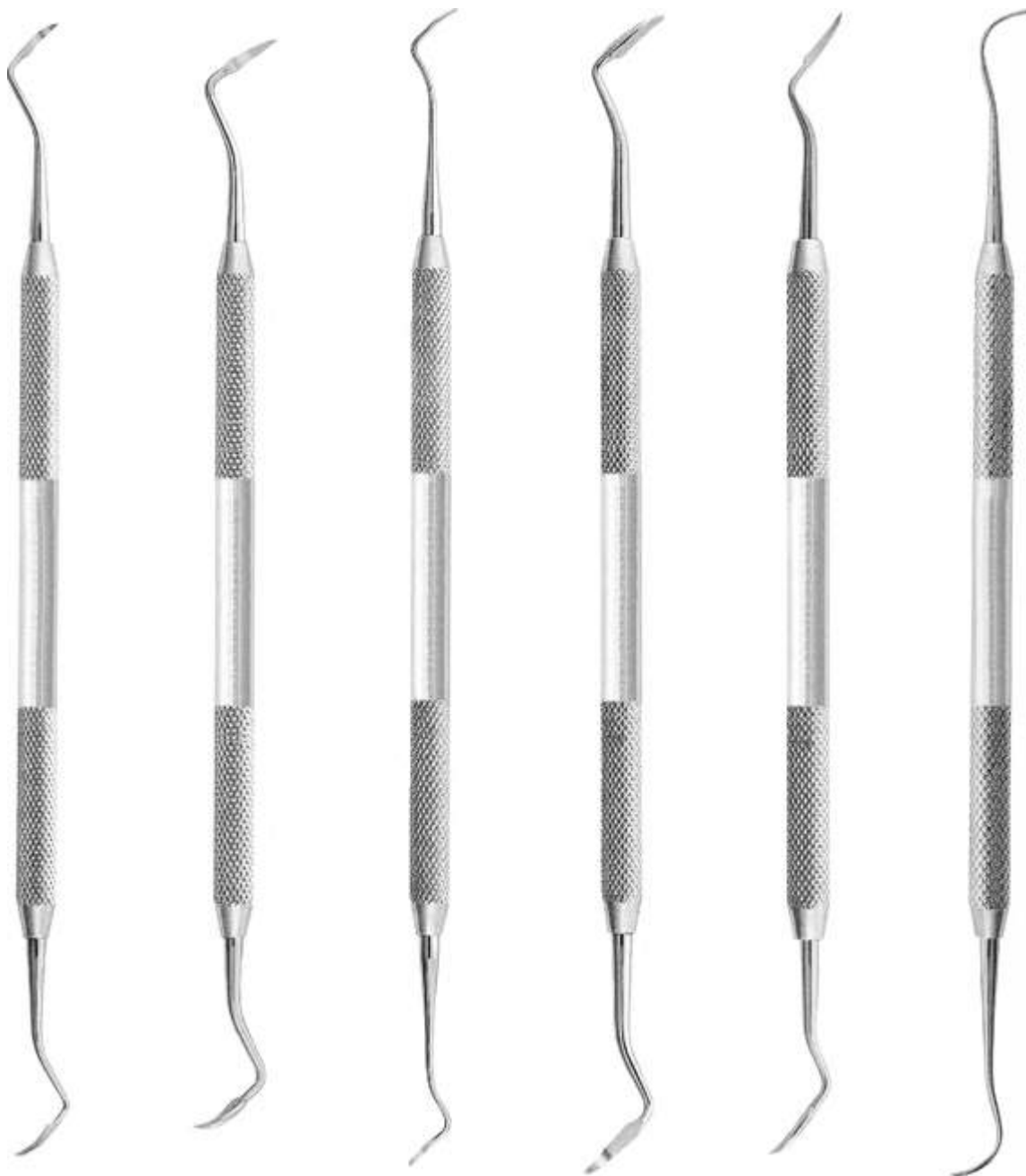

2177
Fig. 2/3
Tavlor

2178
Fig. 204

2179
Fig. 204S

2180
Fig. 6
Crane-Kaplon

2181
Fig. 6S
Mini Crane-Kaplan

2182
Fig. 7/8
Younger-Good

FILE



2183
Fig. 3/7
Hirschfeld

CURETTES AND SCALERS



2184
Fig. 31/32
Jacquette



2185
Fig. 30/33
Jacquette



2186
Fig. 34/35
Jacquette



2187
Fig. 37/38
Jacquette

SCALERS

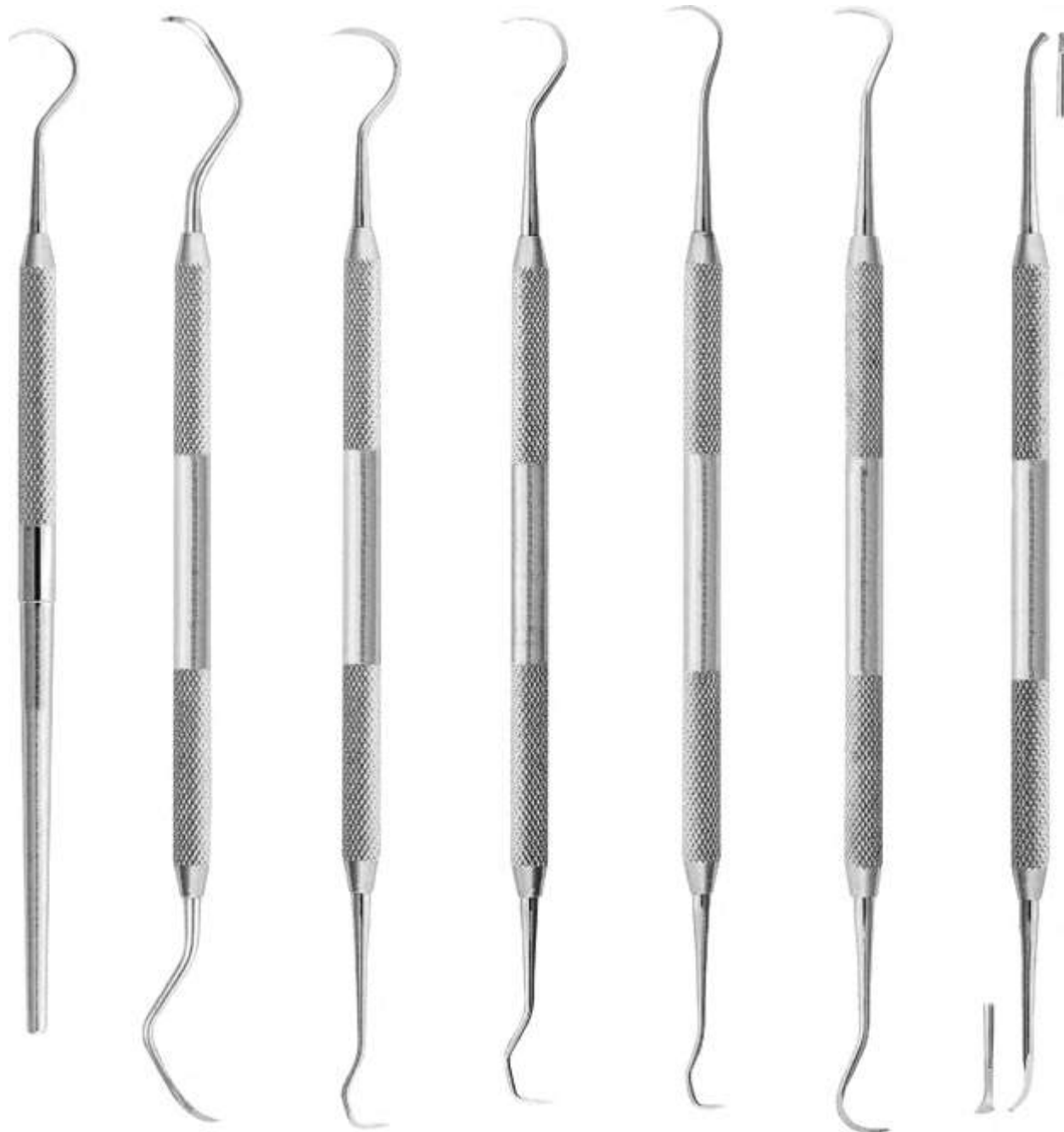

2188
Fig.U15
Towner

2189
Fig. M23
Universal Scaler

2190
Fig. U15/33
Towner Jacquette

2191
Fig. U15/30
Towner Jacquette

2192
Fig. H5/33

2193
Fig. H6/H7

2194
Fig. 1 /2



2195
Fig. 1



2196
Fig. 1L
Sinistro
Left



2197
Fig. 1R
Destro
Right



2198
Fig. 2L
Sinistro
Left



2199
Fig. 2R
Destro
Right



2200
Fig. H5
Hygienist



2201
Fig. H6
Hygienist



2202
Fig. H7
Hygienist



2203
Fig. 33

INSTRUMENT TRAYS



STANDARD
Dimensions
228x182x34 mm.

2204



2205
Orange



2206
Red



2207
Green

Locking Tray Large for 20 instruments, complete with silicone insert frame



STANDARD
Dimensions
288x182x34 mm.

2208



2209
Orange



2210
Red



2211
Green

Locking Tray Large for 15 instruments, complete with silicone insert frame



STANDARD
Dimensions
288x 182x34 mm.

2212



2213
Orange



2214
Red



2215
Green

Locking Tray Large for 10 instruments, complete with silicone insert frame



Set of 2 spare stainless steel knobs complete of washers

Aluminium colour - coded instrument trays - STANDARD - perforated



2216



2217

Colour - coded bases: dimensions mm. 284 × 183 × 17



2218



2219



2220



2221

Lid - grey only, dimensions mm. 288 × 187 × 29

INSERT FRAMES



2222
Insert frame for 10 instruments



2223
Insert frame for 11 instruments

STAINLESS STEEL IMPRESSION TRAYS WITH RETENTION RIM

"NEW SUPER" STAINLESS STEEL IMPRESSION TRAYS WITH RETENTION RIM



2224-U1
XL



2225-U2
L



2226-U3
M



2227-U4
S



2228-U5
XS



2229-L1
XL



2230-L2
L



2231-L3
M



2232-L4
S



2233-L5
XS

"PERMA-LOCK" solid regular stainless steel impression trays with retention rim



2234-U6
XL

2235-U5
L

2236-U4
M

2237-U3
S

2238-U2
XS

2239-U1
XXS



XL
2240-L6



L
2241-L5



M
2242-L4



S
2243-L3



XS
2244-L2



XXS
2245-L1



2246-L2D



2247-L4D



2248-L6D



2249-L2S



2250-L4S



2251-L6S

STAINLESS STEEL IMPRESSION TRAYS

"PERMAL-LOCK" solid regular stainless steel impression trays with retention rim

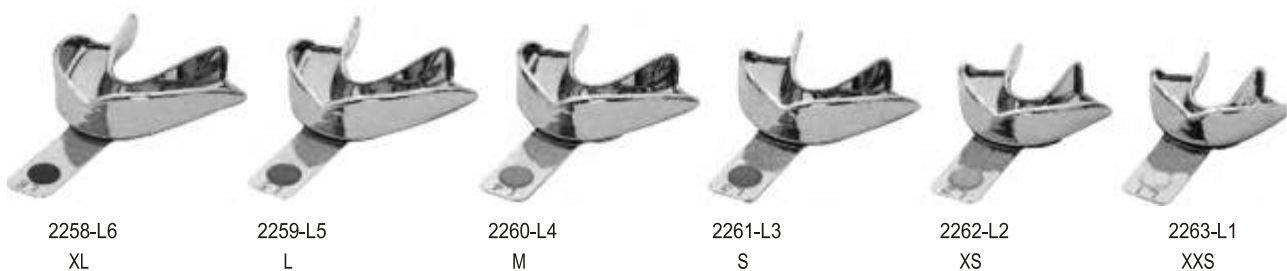
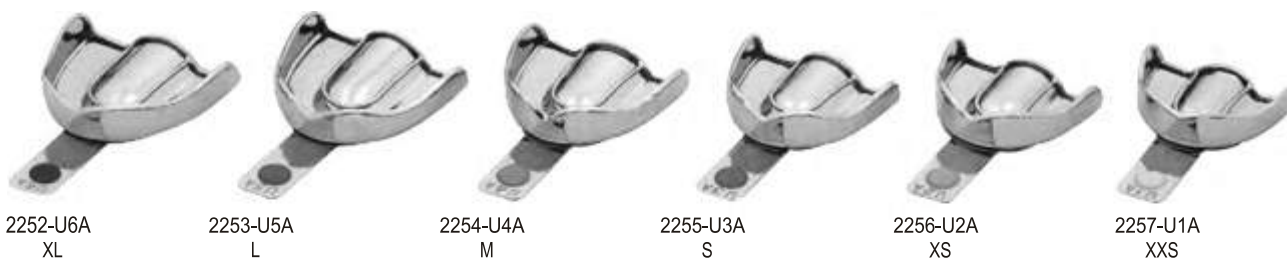

Solid regular stainless steel impression trays without retention rim



2264-U6
XL

2265-U5
L

2266-U4
M

2267-U3
S

2268-U2
XS

2269-U1
XXS



2270-L6
XL

2271-L5
L

2272-L4
M

2273-L3
S

2274-L2
XS

2275-L1
XXS

PARTIAL IMPRESSION TRAYS



2276-L2D



2277-L4D



2278-L6D



2279-L2S



2280-L4S



2281-L6S

STAINLESS STEEL IMPRESSION TRAYS

"ANATOMIC" solid regular stainless steel impression trays
without retention rim

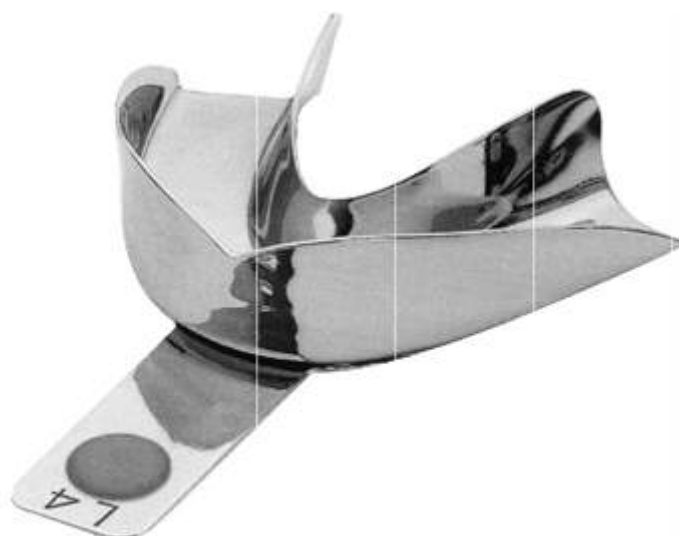

2282-U6A
XL



2283-U5A
L



2284-U4A
M



2285-U3A
S



2286-U2A
XS



2287-U1A
XXS



2288-L6
XL



2289-L5
L



2290-L4
M



2291-L3
S



2292-L2
XS



2293-L1
XXS

"PERMA-LOCK" Perforated regular stainless steel impression trays with retention rim

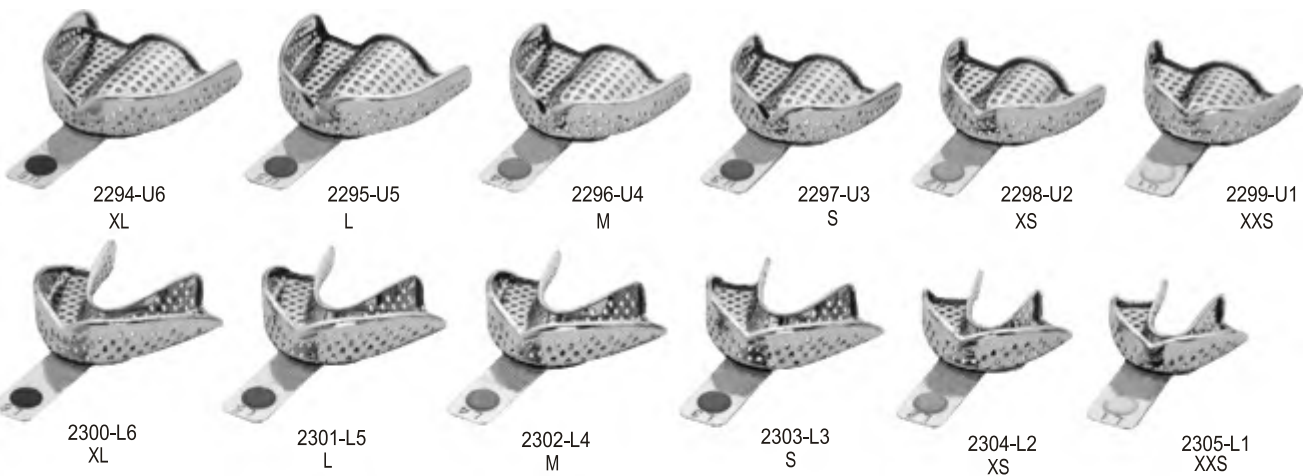

"PERMA-LOCK" partial Impression Trays



2314



2314 TECHICAL DATAS

Intercondylar distance	120 mm.
Condylar inclination	fixed at 30°
Bennet angle	fixed at 7°
Incisal table inclination	10°
Distance between mounting plates	90-110 mm.
Weight	700 gr.
Opening	108°

Features mod. 2314

Lightweight anatomic articulator made of aluminium die-casting. It can be used following the geometrical laws of medium values (Bonwill triangle). Fizing according to centric. Automatic return to the hinge axis with springs. Anti-shock hinge rod in case articulator falls accidentally. Bigger size lock screws for mounting plates.

Increased height and width

More space when using removable stumps systems.
More space for installation of mobile prosthesis with high chewing or big base.
More space when using magnetic plates.
Better back entrance.
Variable internal working distance.



Steel parts

Incisal guide rod and bearing rod for 180° opening are in stainless steel.
Stainless steel hinge rod.

Hinge rod

Antishock System.

Articulator holding

Anatomic back shoulders favour a practical and efficient holding of the articulator.

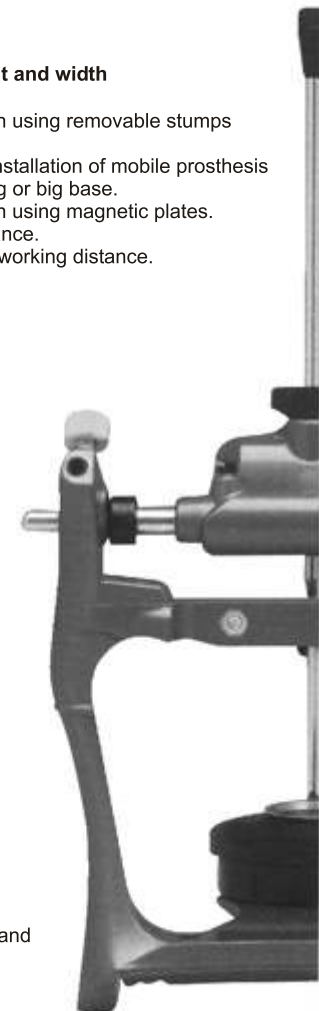

2314
TECHICAL DATAS

Intercondylar distance	120 mm.
Condylar inclination	fixed at 30°
Bennet angle	fixed at 7°
Incisal table inclination	10°
Distance between mounting plates	90-110 mm.
Weight	700 gr.
Opening	108°

2315



Features mod. 2315 - same features as mod. 2314 plus:
Adjustable back rod by registration screw to work without incisal rod by keeping constant trajectories and inclinations during side and back/forward movements. Pure translation movement(key and instructions included).

Back rod on the upper side

- Unchanged back entrance and visibility
- Easy mechanisms regulation

Hinge rod

Pure translation movement allowed



2316



Features mod. 2316

Lightweight anatomic articulator made of aluminium die-casting. It can be used following the geometrical laws of medium values (Bonwill triangle).

Fixing according to centric. Automatic return to the hinge axis with springs. Perfect stability also in reversed position. Easy access and visibility to the lingual surfaces. Interchangeable self centring aluminium mounting plates . Or magnetic plates. Pure translation movement (key and instructions included).

Anti-shock hinge rod in case articulator falls accidentally.

Bigger size lock screws for mounting plates.

2316-2317

TECHICAL DATAS

Intercondylar distance	110 mm.
Condylar inclination	fixed at 30°
Bennet angle	fixed at 7°
Incisal table inclination	10°
Distance between mounting plates	85 mm.
Weight	400 gr.
Opening	108°
Opening	108°
Opening	108°

2317



Features mod. 2317

same features as mod. 2316 plus:

Bearing rod for 180° opening

Perfect stability in fully opened (reversed) position

2318



**Features mod.2318
same features as mod. 2317 plus :**

Adjustable back rod by registration screw to work without incisal rod by keeping constant trajectories and inclinations during side and back/forward movements. Pure translation movement (key and instructions included).

Anti-shock hinge rod in case articulator falls accidentally. Bigger size lock screws for mounting plates. Interchangeable self centring aluminium mounting plates or magnetic plates

Spare parts



Screw for Articulators mod. 2314-2315 without spacer



2319

OCCLUSOR

2322



2320



2321



WAX AND MODELLING CARVERS

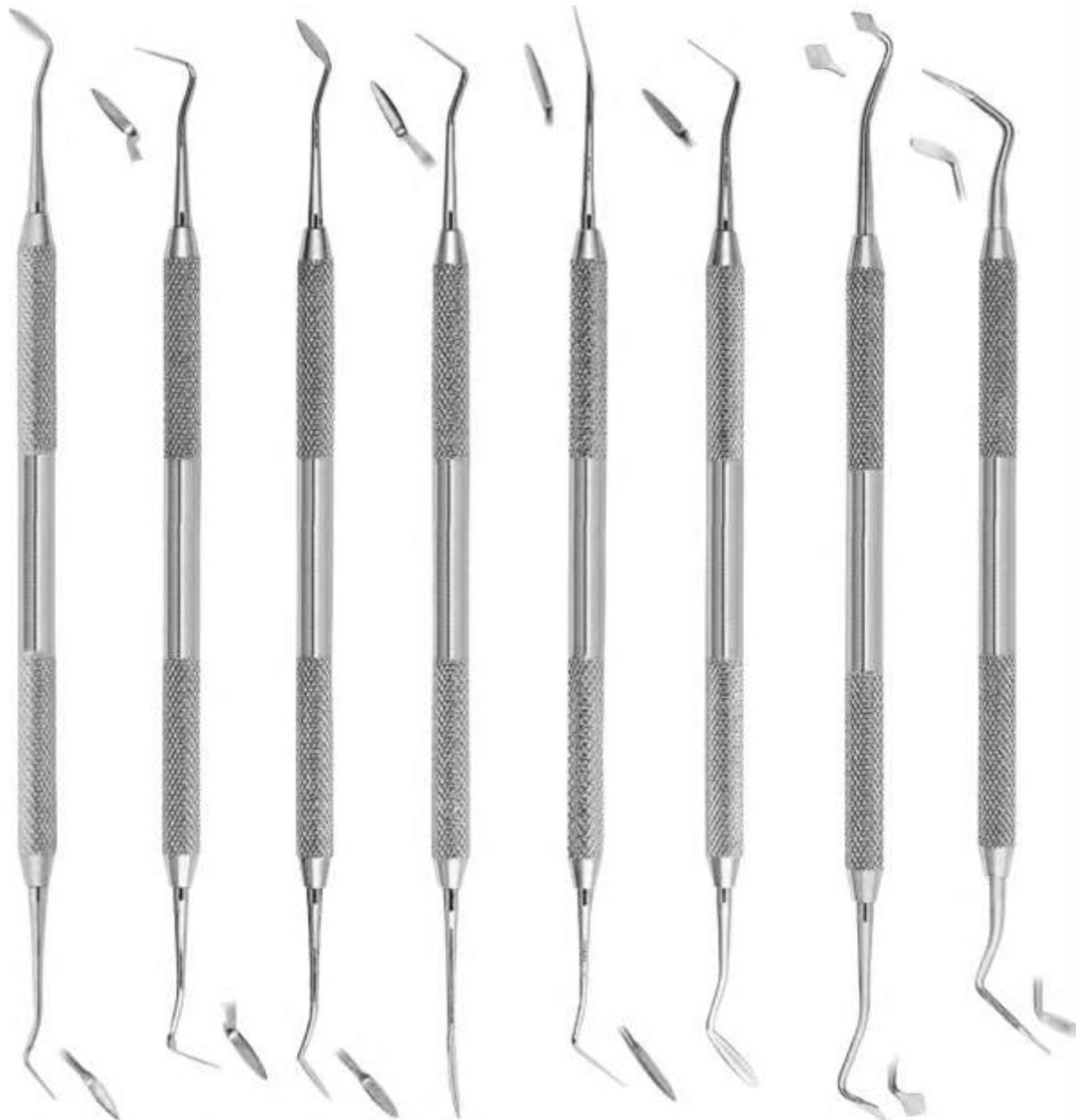

2323
Fig. 1 /2
Hollenback

2324
Fig. 3
Hollenback

2325
Fig. 3S
Hollenback

2326
Fig. 1
Ward

2327
Fig. 1S
Ward

2328
Fig. 2
Ward

2329
Fig. 1
Frahm

2330
Fig. 2
USC

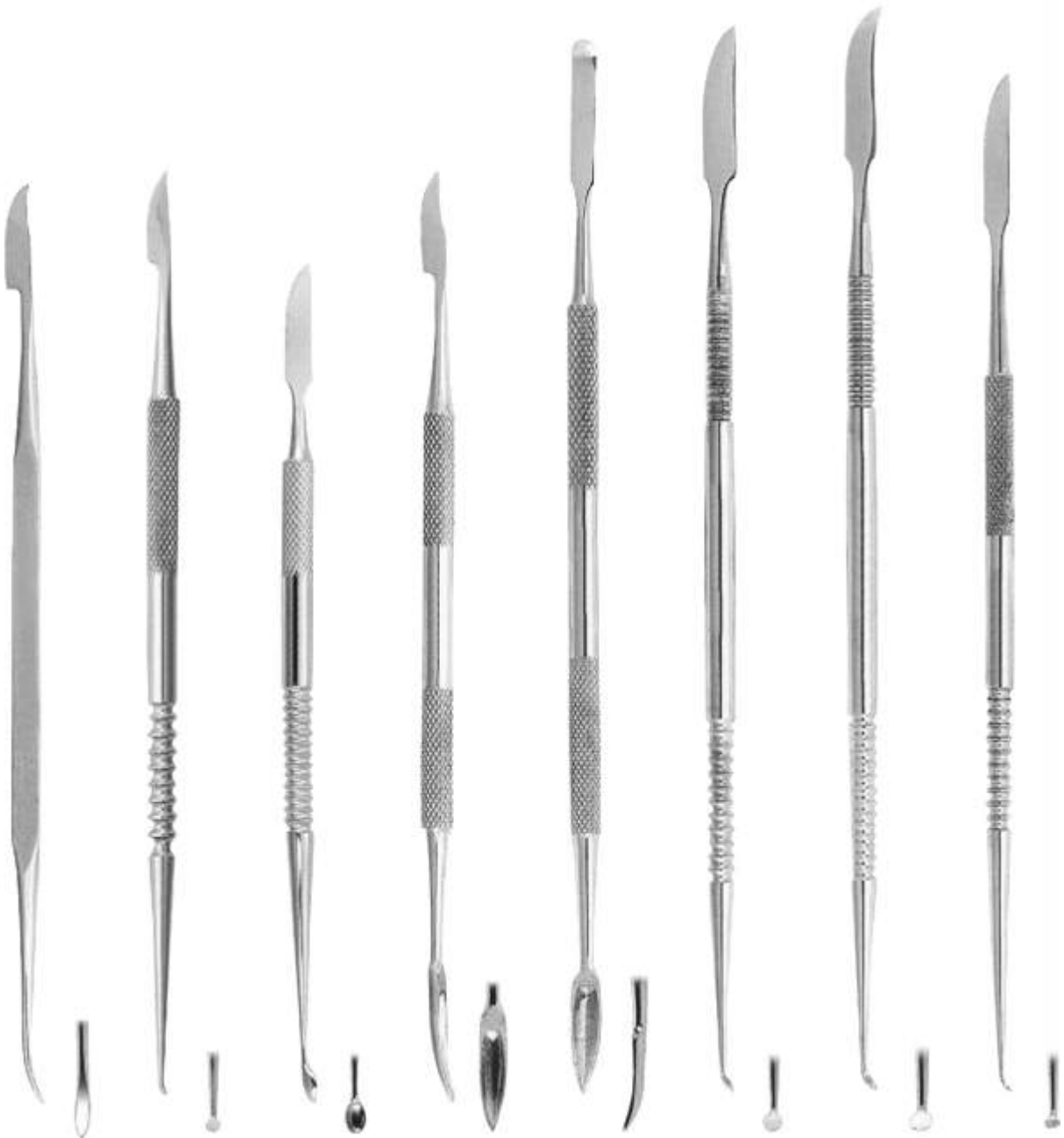

2331
Hylin

2332
Hylin-Le Cron

2333
Hylin-Ceramica

2334
Hylin

2335

2336
Le Cron

2337
Le Cron

2338
Le Cron

LABORATORY TWEEZERS

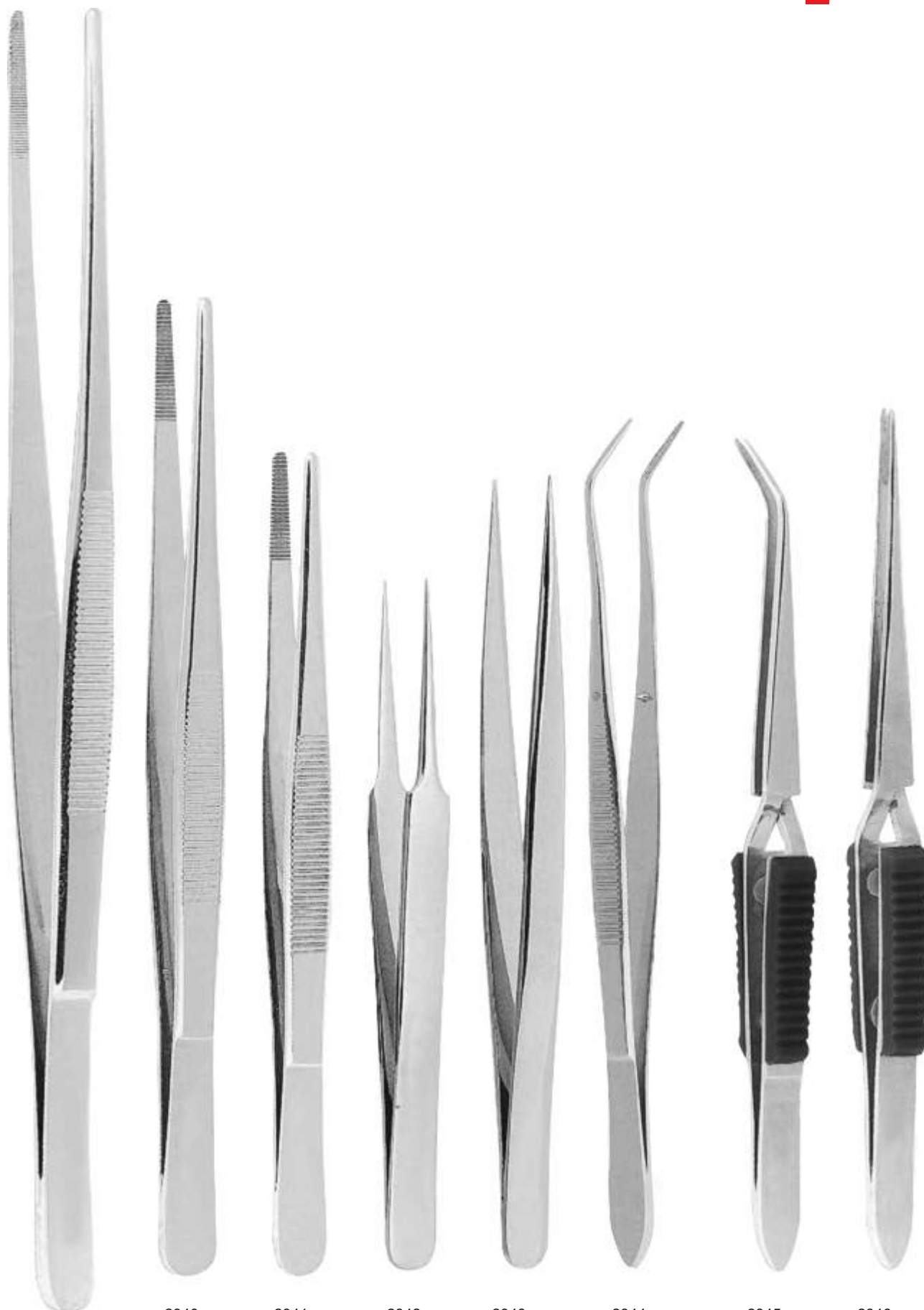

2339
Fig.3
cm. 26

2340
Fig.4
cm. 18

2341
Fig.3
cm. 15

2342
Fig.3
cm. 11.5

2343
Fig.2
cm. 12

2344
Fig.3
cm. 16

2345
Fig.2
cm. 16

2346
Fig.1
cm. 16.5

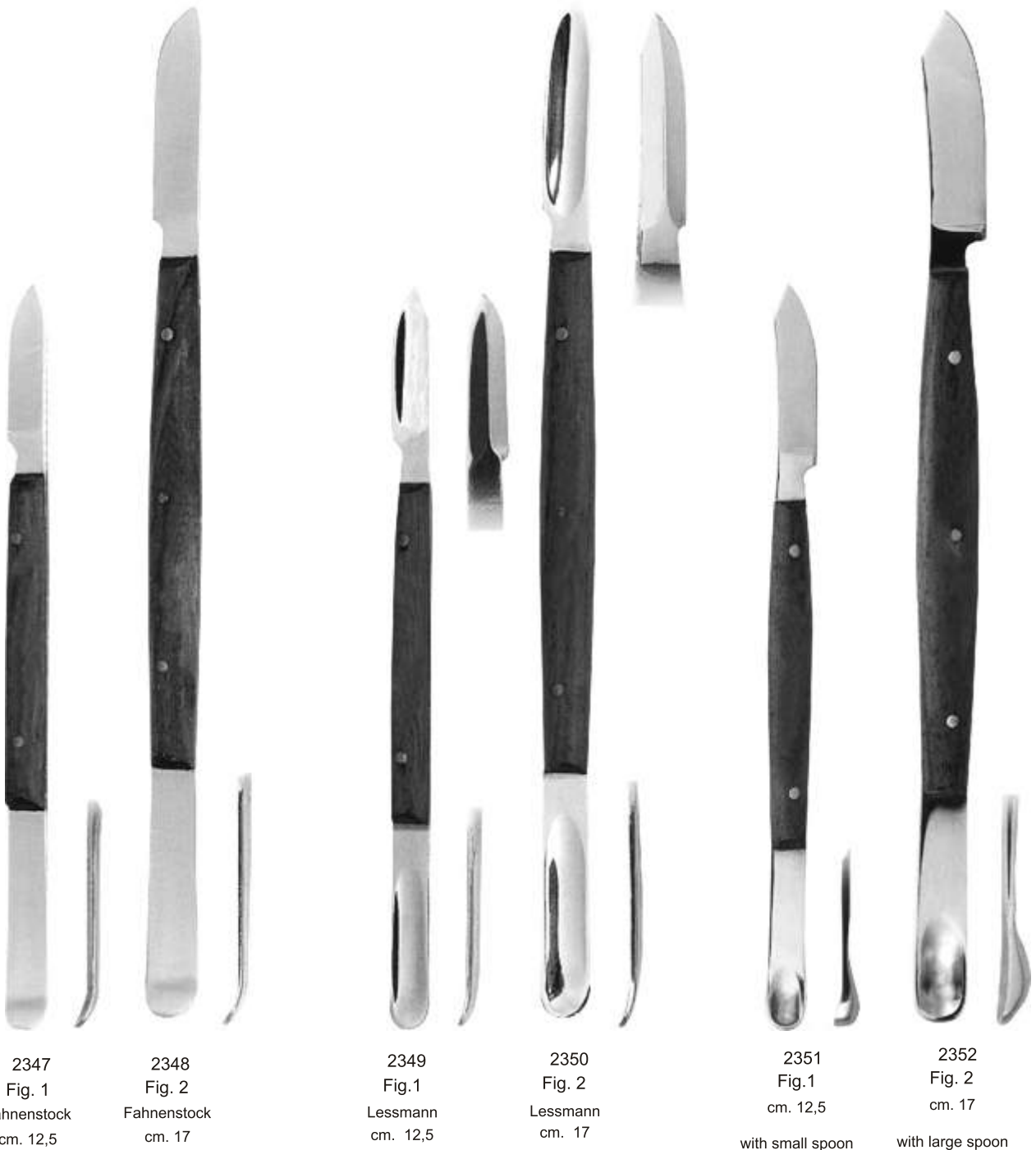

The wooden handle may suffer color changes

PLASTER KNIVES



2353
Fig. 1
cm. 17



2354
Fig. 2
Gritman
cm. 17



2355
Fig. 3
cm. 16



2356
Fig. 4
cm. 16

The wooden handle may suffer color changes

RIGID

FLEXIBLE



The wooden handle may suffer color changes

SPATULAS FOR PLASTER ALGINATE AND ELASTOMERS

Rigid



2362
Fig. 8
cm. 20

Alginato



2363
Fig.9
cm. 22,5

Rigid



2364
Fig.3
cm. 18,5

Flexible



2365
Fig. 4
cm.19.5

Elastomers

The wooden handle may suffer color changes

Calipers



2366
Boley
cm. 14

Measuring range

} 0-100mm.



Spring Caliper
for wax

2367
Spring caliper
for metal

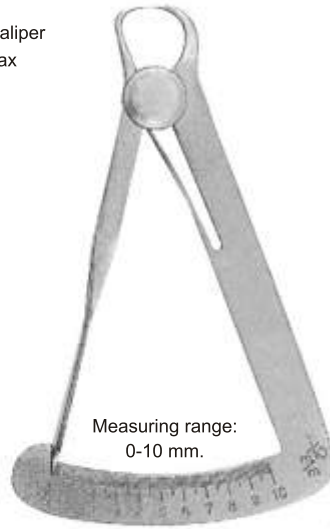

Measuring range:
0-10 mm.

Iwanson

2368
18 cm



2369

Aluminium caliper up to mm. 200.
Graded in mm and inches.



2370
Townley

Caliper graded
in mm and inches



2371
Jameson

Caliper

Pliers for Telescope Crowns



2372



2373

Crown Pliers

2374
13 cm



Plaster Cutting Pliers



2375
cm. 19,5



Mallets



2376
cm. 22

Riveting mallets



2377
cm. 22



2378
cm. 20

Horn mallet

CRUCIBLE TONGS.

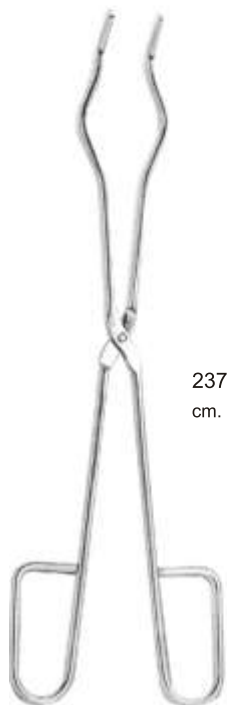

2379
cm. 31

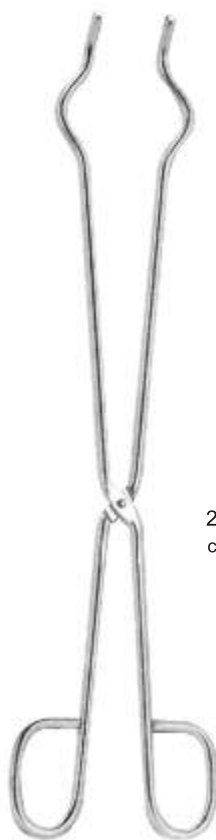

2380
cm. 40



2381
cm. 51

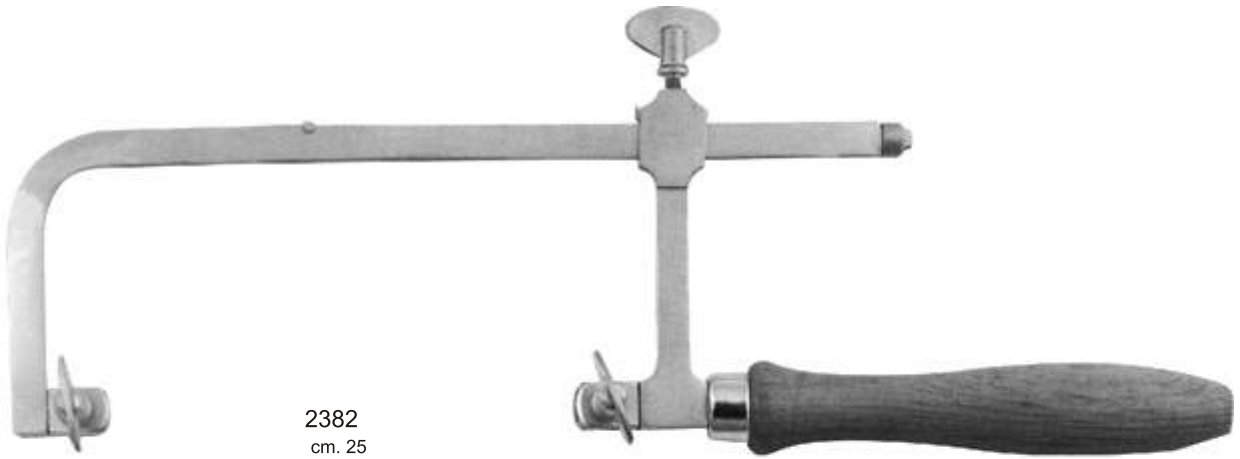

2382
cm. 25

Package of 12



2384

0,25×3 mm.



2385

0,25×5 mm.



2386

0,12×5 mm.



2383

Saw for models cm.18

UNIVERSAL PILERS



2387
Universal

Universal pliers for bending wires up to 0,9 mm. (.035") or cutting up to 0,7 mm. (.028").



2388
Universal

Universal pliers for bending wires up to 0,9 mm. (.035") or cutting up to 0,7 mm (.028")



2389
Waldsachs

Waldsachs universal pliers bending wires up to 1,0 mm (.039") or cutting up to 0,7 mm. (.028")

LOOP FORMING PLIERS



2391

Round-Concave pliers for loop forming and bending of thin round and square wires up to 0,5 mm. (.020")



2392
Tweed

Tweed Loop Forming Pliers. For round or rectangular wires up to 0,56 × 0,7 mm. (.022" × .028"). Replaceable cylindrical beak with three sizes: 1,15 mm. (.045"), 1,50 mm. (.059"), 1,90 mm. (.075"). Concave beak with slight parallel serrations, to keep the wire in proper position



2390
Nance

Nance loop closing pliers, for bending of stop loops and special pliers for Adams' clasps. Wires up to 0,7 mm. (.028").



2393
Tweed

Tweed Loop Forming Pliers. For making perfect Omega Loops with round or rectangular wires up to 0,56 × 0,7 mm. (.022" × .028") The concave beak is exactly the same as pliers, 5809-1



2394
Tweed

Single diameter loop forming pliers. Wire up to 0,56 × 0,7 mm. (.022" × 0.28"). Replaceable concave beak has only diameter section of 1,50mm. (.059")

ORTHODONTIC PLIERS



2395
Reynolds
Reynolds contouring pliers



2396
Lingual arch pliers used to form double and triple back bends in 0,7 mm, (.028") or 0,9 mm, (.035") wire for insertion in lingual sheaths



2397
Weingart
Utility and speciality pliers weingart pliers with serrated tips



2398
De La Rosa
De La Rosa arch forming pliers. Designed to form and contour arch wires on round or rectangular wire. The beak has grooves of 0,4mm, (.016") 0,46mm, (.018") and 0,56mm, (.022")



2399
De La Rosa
Arch forming pliers with non-grooved contouring surface for the forming of precise arches.

BAND REMOVERS PLIERS



2400
Direct bonding bracket remover with "Wide beak" pad. Designed for quick, comfortable removal of direct bonded brackets and elimination of adhesive residues. Wide tip.



2401
Direct bonding bracket remover with "Narrow beak" pad.



2402
Short nose pliers for easy band removal. Interchangeable plastic pad.



2403
Posterior band remover (long). These long style pliers are excellent for posterior band removing, also used to remove direct bonding bracket.

LIGATURE PLIERS AND WIRE CUTTERS



2404

Micro-miniature light wire cutter. It cuts soft ligature wires. For use in case of limited access. Caution: maximum cutting capacity: soft ligature wire up to 0,30 mm. (.012")



2405

Wire cutter. For ligature wires and pins. It is strong enough to bend archwire ends after distal cutting. Maximum cutting capacity up to 0,56x0,7 mm. (.022"x.028")



2406

Wire cutter. For ligature wires and pins. It is strong enough to bend archwire ends after distal cutting. Maximum cutting capacity: up to 0,9 mm. (.036")



2407

Micro-miniature light wire cutter. It cuts soft ligature wires. For use in case of limited access. Caution: maximum cutting capacity: soft ligature wire up to 0,30 mm. (.012") With tungsten carbide insert.



2408

Wire cutter. For ligature wires and pins. It is strong enough to bend archwire ends after distal cutting. Maximum cutting capacity up to 0,56 x 0,7 mm. (.022" x .028") with tungsten carbide insert.



2409

Wire cutter. For ligature wires and pins. It is strong enough to bend archwire ends after distal cutting. Maximum cutting capacity: wires up to 1,5 mm (.044") With tungsten carbide insert.

DISTAL END CUTTERS

D.B. BRACKET REMOVER PLIERS



2410

Distal end cutter -safety hold- a precision cutter designed for distal arch cutting in the patient's mouth. It cuts hard wires and holds the loose distal end preventing any damaging of oral tissue. Maximum cutting capacity rectangular wires up to 0,56 x 0,7 (022" x .028"), round wires up to 0,5 mm. (.022")



2411

Micro-distal end cutter -safety hold-



2412

Direct bonding bracket remover (wide). The removers grip firmly for easy incisal-gingival (vertical) use or, if needed, for mesial-distal (horizontal) use with the same ease.



2413

Distal end cutter -safety hold- a precision cutter designed for distal arch cutting in the patient's mouth. It cuts hard wires and holds the loose distal end preventing any damaging of oral tissue. Maximum cutting capacity rectangular wires up to 0.56 x 0.7 (022" x .028"), round wires up to 0,5 mm. (.020"). Tungsten carbide insert.



2414

Direct bond attachment remover (angled). For removing all bonded attachments, May be used mesialdistal (horizontal) or incisal-gingival (vertical) in anterior areas. Angled perfectly for easy access to difficult posterior areas.

ORTHODONTIC PLIERS



2415
Mc Kellops
Round and concave heavy wire pliers.
For forming loops in hard clasp
wires or labial arch
wires up to 0,8 mm. (.032").



2416
Johnson
Contouring band pliers,
Johnson pliers.

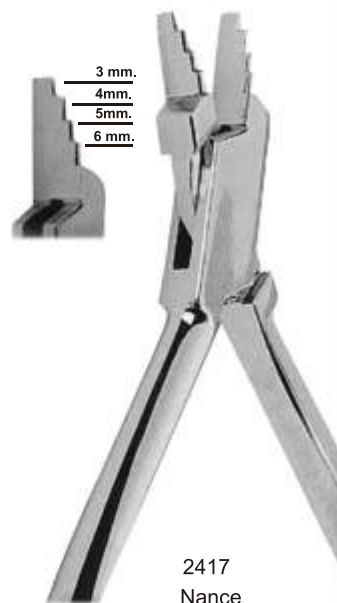

2417
Nance
Nance loops closing pliers
Nance style. With 4 steps tip
for forming various size loops in
rectangular and round wires,
up to 0,7 mm. (.028").



2418
Young
Loop forming pliers
Young pliers wires up to 0,7 mm. (.028").



2419
Wire cutter. For ligature wires and pins. It is strong
enough to bend archwire ends after distal cutting.
Maximum cutting capacity: wires up to 1,5 mm.
(.044"). With tungsten carbide insert.



2420
Wire bending pliers,
for wires up to 0,9 mm. (.036").



2421
Double rounded jaw wire
bending pliers, for wires
up to 0,7 mm. (.028").



2422
Angle
Bird Beak Angle pliers for
bending round, square or rectangular
wire up to 0,7 mm. (.028").

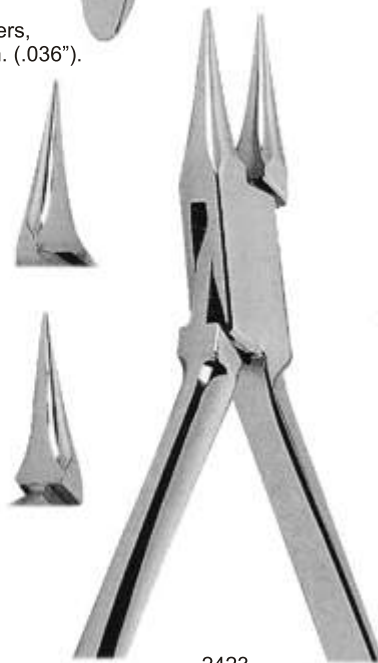

2423
Double rounded jaw wire bending pliers,
for wires up to 0,7 mm. (.028").



2424
Angle
Bird beak pliers for bending round,
square or rectangular
wire up to 0,7 mm. (.028"). With cutter

ORTHODONTIC PLIERS



2325
Adams
Adams pliers for bending
wires up to 0,7 mm. (.028").



2426
Adams
Adams pliers for bending
wires up to 0,7 mm. (.028").



2427
Tweed
Tweed loop forming pliers.
For forming loops in
wires up to 0,56 mm. (.022").

TORQUING PLIERS



2428
Aderer
Aderer three jaws bending pliers.
For wires up to 0.7 mm. (.028")



2429
Aderer
Aderer three jaws bending pliers.
For wires up to 0.7 mm. (.028")



2430

Light Bird Beak pliers for bending round, square or rectangular wires up to 0,4 mm. (.016").



2431
Tweed (Angle)

Tweed (Angle) arch bending pliers - short - Pliers with beaks (10 mm.) designed for convenient handling of square or rectangular wires the blades are parallel at 0,5 mm. (.020") pliers' opening.



2432
How

How pliers Universal well balanced for optimum control. Completely lip-safe beaks.



2433
How

How Universal pliers -curved 45°- well balanced for optimum control Completely lip-safe beaks

ORTHODONTIC PLIERS



2434

Flat nose pliers with smooth beaks for bending wires up to 0,7 mm. (.028").



2435

Bending wires up to 0,7 mm. (.028").



2436

Bending wires up to 0,7 mm. (.028").



2437

Bending wires up to 0,7 mm. (.028").

2438
Stainless steel pliers tray standard dimensions



A

Apexo (Root Elevators)	39,44
Adson (Needle Holders)	60
Arruga (Needle Holders)	62
Adson (Tissue Pliers)	77
Adson Brown (Tissue Pliers-Suture Pliers)	78
Aspirator Tips (Surgical Saliva Ejectors)	81
Allen (Implant Surgery)	84
Annular Osteotomes (Implant Surgery)	86
Anterior (Rubber Dam Clamps)	109
Ainsworth (Rubber Dam Clamps)	111
Amalgam Carriers	113,114
ASH (Excavators)	130,132
Aluminium Instrument Trays	156
Articulators	163,164,165,166,167,168
Angle (Orthodontic Pliers)	186
Adams (Orthodontic Pliers)	187
Aderer (Orthodontic Pliers)	187

B

Blumenthal (Bone Rongeurs)	31
Beyer (Bone Rongeurs)	32
Bein (Root Elevators)	35,42,43
Baumgartner (Needle Holders)	60
Brass Syringe (Intra-Ligamental Syringes)	64
Backhaus (Towel Clamps)	69
Buchwald (Retractors-Tongue Depressors)	72
Brunings (Retractors-Tongue Depressors)	72
Bowman (Retractors)	76
Bone Thickness Gauge (Implant Surgery)	82
Bone Injector (Implant Surgery)	82
Bone Curette (Implant Surgery)	82
Bone Well (Implant Surgery)	82
Buser (Implant Surgery)	84
Bone scraper (Implant Surgery)	90
Blumenthal (Implant Surgery)	92
Brewer (Rubber Dam Clamps)	111
Ball (Filling Instruments)	123
Boley (Crown Instruments)	134
Buck (Preiodontal Instruments)	146
Boley (Laboratory Instruments)	176
Band Removers Pliers (Orthodontic Pliers)	182

C

Cleveland 5 (Bone Rongeurs)	32
Cleveland-gardner (Bone Rongeurs)	32
Coleman (Root Elevators)	34
Cryer (Root Elevators)	40,42
Coupland (Root Elevators)	40
Cogswell (Root Elevators)	39
Coupland (Root Elevators)	41
Chompret (Sundesmotomes)	50
Crile-Wood (Needle Holders)	60
Castroviejo (Needle Holders)	63
Castroviejo-Barraquer (Needle Holders)	63
Crile (Haemostatic Forceps)	66
Collin (Mouth Gags-Tongue Forceps)	71
Columbia (Retractors-Tongue Depressors)	72
Compactors (Implant Surgery)	82
Crane-Kaplan (Cotton & Dressing Pliers)	94
Cattoni (Double-Ended Explores)	98,99
Crown Instruments	133

Crown Spreaders (Crown Instruments)	135
Crane Kaplan (Preiodontal Instruments)	143
Crane-Kaplan (Preiodontal Instruments)	146, 151
Crown Pliers (Laboratory Instruments)	176
Crucible Tongs (Laboratory Instruments)	177

D

Dean (Gum Scissors)	53
Derf (Needle Holders)	61
Dental Syringes	65
Distal (Cavity Preparation Instruments)	126
Darby-Perry (Excavators)	130,132
Decimal Caliper (Crown Instruments)	134
Didner (Matrix Retainers)	137
Destro (Scalers)	154
De La Rosa (Orthodontic Pliers)	181
Distal End Cutters (Orthodontic Pliers)	184
D.B Bracket Remover (Orthodontic Pliers)	184

E

Extracting Forceps	02-03-04-05-06-07 08-09-10-11-12-13-14-15-16-17
Extracting Forceps (Mead Pattern)	18
Extracting Forceps (Anatomically Shaped Handle)	19-20-21-22
Extracting Forceps (American Pattern)	23-24-25 26-28
Extracting Forceps (Children)	27
Extracting Forceps (Children - Klein Pattern)	29
Eiselberg-Mathieu (Needle Holders)	62
Excavators	127,129,131

F

Friedman (Bone Rongeurs)	31
Flohr (Root Elevators)	35,42,43
Friedman (Root Elevators)	41
Farabeuf (Retractors)	73
Frazier (Surgical Saliva Ejectors)	81
Freer (Implant Surgery)	83
Filling Instruments	117,118
Fox Amalgam (Filling Instruments)	121,122
Frahm (Amalgam Carves)	125
Furrer (Crown Instruments)	134
Freer (Periodonral Instruments)	140
Frahm (Wax and Modelling Carvers)	169
Fahnenstock (Wax Knives)	172

G

Goldman-Fox (Bone Rongeurs)	31
Gum Scissors	53
Goldman-fox (Gum Scissors)	54
Gillies (Needle Holders)	61
Gross-Maier (Dressing Forceps)	70
Graduated scalpels (Implant Surgery)	83
Gold mon-Fox (Implant Surgery)	84
Goldman Fox (Implant Surgery)	92
Goldman-Fox (Periodontal Pocket Probes)	97
Goldman-Fox Williams (Periodontal Pocket Probes)	97
Goldman Fox Punta Piatta (Double-Ended Explores)	101

Goldman Fox Punta Piatta (Combination Explorers Probes)	102,103
Glass Plate (Cement Spatulas)	115
Goldman-Fox (Preiodontal Instruments)	143,146,149
Gracey AF / Type	147
Gracey MF / Type	148
Gritman (Plaster Knives)	173

H

Hylin (Root Elevators)	34
Heidbrink (Root Elevators)	39, 44
Heidbrink (Root Tip Picks)	47
Hartmann (Haemostatic Forceps)	67
Hartmann (Haemostatic Forceps)	68
Hourigon (Implant Surgery)	84
Hemingway (Implant Surgery)	86
Handle fer Micro Blades (Implant Surgery)	90
Heidemann Separating Spatulas	116
Hollenback (Filling Instruments)	119
Halstead Mosquito (Crown Instruments)	136
Herbert (Periodonral Instruments)	139
Howard (Bone Files)	142
Hirschfeld (Preiodontal Instruments)	152
Hygienist (Scalers)	154
Hollenback (Wax and Modelling Carvers)	169
Hylin (Wax and Modelling Carvers)	170
Hylin-Le Cron (Wax and Modelling Carvers)	170
Hylin Ceramica (Wax and Modeling Carvers)	170
How (Orthodontic Pliers)	188

I

Implant Site Dilators (Implant Surgery)	87
Implant Surgery	88
Ivory (Rubber Dam Clamps)	111
Ivory Lightweight (Rubber Dam Clamps)	111
Interproximal (Amalgam Carves)	125
Interproximal Off-Angle (Amalgam Carves)	125
Iwanson (Crown Instruments)	134
Ivory (Matrix Retainers)	137
Instrument Trays	155
Impression Trays	157,158,159,160,161,162
Iwanson (Laboratory Instruments)	176

J

Jones (Towel Clamps)	69
Jacquette (Preiodontal Instruments)	152
Jameson (Laboratory Instruments)	176
Johnson (Orthodontic Pliers)	185

K

Kopp (Helicoidal Extracting Forceps)	36
Kit Syndesmotomes	49
Kit for Oral Surgery	52
Kelly (Gum Scissors)	55
Kocher (Haemostatic Forceps)	66
Kilner (Retractors)	73
Kocher (Retractors)	75
Kelly (Crown Instruments)	136
Konig (Periodonral Instruments)	140
Kirkland (Preiodontal Instruments)	145

L

Luer (Bone Rongeurs)	31
Lecluse (Root Elevators)	45
La Grange (Gum Scissors)	55
Locklin (Gum Scissors)	55
Lichtenberg (Needle Holders)	62
Longenbeck (Retractors)	75
Labial (Retractors)	76
Labial Retractor (Implant Surgery)	91
Luer (Implant Surgery)	92
Locking (Cotton & Dressing Pliers)	94
Luks (Endodontic Instruments)	105
Ladmore (Filling Instruments)	123
Le Cron (Wax and Modelling Carvers)	170
Laboratory Tweezers	171
Lessmann (Wax Knives)	172
Ligature Pliers & Wire Cutters (Orthodontic Pliers)	183

M

Mini Friedman (Bone Rongeurs)	31
Mead (Bone Rongeurs)	31
Mini-ruskin (Bone Rongeurs)	32
Miller-Apexo (Root Elevators)	37, 44
Mac Millan (Root Elevators)	41
Mayo (Surgical Scissor)	57
Metzencaum (Surgical Scissor)	57
Metzencaum Delikat (Surgical Scissor)	57
Mayo-Hegar (Needle Holders)	61
Mathieu (Needle Holders)	62
Micro-Mosquito (Haemostatic Forceps)	67,68
Molt (Mouth Gags-Tongue Forceps)	71
Middeldorpf (Retractors)	76
Micro-Adson (Tissue Pliers)	77
Molto Fine (Tissue Pliers)	77
Mead (Implant Surgery)	83
Molt (Implant Surgery)	84
Middeldorpf (Implant Surgery)	91
Mini Friedman (Implant Surgery)	92
Marquette (Filling Instruments)	119
Markley (Filling Instruments)	120
Mesial (Cavity Preparation Instruments)	126
Miller (Crown Instruments)	135
Mead (Periodonral Instruments)	139
Miller (Bone Files)	141
Mini Friedman (Preiodontal Instruments)	143
Mc Call (Preiodontal Instruments)	150
Mini Crane Kaplan (Preiodontal Instruments)	151
Mallets (Laboratory Instruments)	177
Mc Kellops (Orthodontic Pliers)	185

N

Neumann (Gum Scissors)	54
Noyes Castroviejo (Gum Scissors)	56
Nabers (Periodontal Pocket Probes)	97
Nance (Orthodontic Pliers)	180,185

O

Olsen-Hegar (Needle Holders)	60
Oringer Medium (Retractors-Tongue Depressors)	72
Osteotomes (Implant Surgery)	85
O.M.S. (Double-Ended Explores)	100
Oval spoon (Excavators)	128
Ochsenbein (Preiodontal Instruments)	144
Orban (Preiodontal Instruments)	145

P

Pott (Root Elevators)	46
Presentation Set	51
Pean (Haemostatic Forceps)	66
Partsch (Implant Surgery)	83
Prichard (Implant Surgery)	84
Periotomes (Implant Surgery)	85
Periosteal Elevators (Implant Surgery)	89
Plastic Filling Instruments	124
Partsch (Periodonral Instruments)	139,140
Polokoff (Bone Files)	141
Pliers Tray	190

Q

Qinby (Gum Scissors)	55
-----------------------------	----

R

Root Splinter Forceps	30
Root Elevators Kit	33
Roser-Koenig (Mouth Gags - Tongue Forceps)	71
Rhein (Explorers Anatomic Handle)	95
Root Canal (Double-Ended Explores)	98,99
Root-Canal Explorers (Endodontic Instruments)	106,107
Root-Canal Excavators (Endodontic Instruments)	107
Rubber Dam Clamps	109,110,112
Rhodes (Preiodontal Instruments)	144
Reynolds (Orthodontic Pliers)	181

S

Set For Extraction And Oral Surgery	01
Schmeckeberier Apexo (Root Elevators)	35,43
Seldin (Root Elevators)	37,38
Stout (Root Elevators)	38
Seldin (Root Elevators)	39,44
Syndesmotomes	48
Sullivan (Gum Scissors)	56
Spencer (Surgical Scissor)	57
Stevens (Surgical Scissor)	58
Scalpel Handles - Blades	59
Syringe (Intra-Ligamental Syringes)	64
Syringe Stand (Intra-Ligamental Syringes)	64
Schaedle (Towel Clamps)	69
Sternberg (Retractors-Tongue Depressors)	72
Senn-Miller (Retractors)	73
Suture Pliers (Tissue Pliers-Suture Pliers)	78
Semken-Taylor (Tissue Pliers-Suture Pliers)	78
Sinus Lift Curettes (Implant Surgery)	87
Spare Filter Medium Grid (Implant Surgery)	90
Sternberg (Implant Surgery)	91
Spreader (Endodontic Instruments)	104
Stoks (Rubber Dam Clamps)	111
Seldin Retractor (Periodonral Instruments)	140
Sugarman (Preiodontal Instruments)	144
Schluger (Preiodontal Instruments)	144
Sanders (Preiodontal Instruments)	146
Sinistro (Scalers)	154
Spatulas for Plaster Alginate And Elastomers	174,175
Saw for models (Saw and Blades)	178

T

Toennis (Needle Holders)	61
Tissue Pliers	79-80
Trephine Burs (Implant Surgery)	87
Tanner (Filling Instruments)	119
Telescope Crown Pliers (Crown Instruments)	136
Tofflemire Universal (Matrix Retainers)	137
Tofflemire Junior (Matrix Retainers)	137
Tofflemire Senior (Matrix Retainers)	137
Tofflemire (Matrix Bands)	138
Tomati (Preiodontal Instruments)	143
TG Chisel (Preiodontal Instruments)	145
Taylor (Preiodontal Instruments)	151
Towner (Scalers)	153
Towner Jacquette (Scalers)	153
Townley (Laboratory Instruments)	176
Tweed (Orthodontic Pliers)	180,187
Tweed Angle (Orthodontic Pliers)	188

U

Ultralight Mirror	
(Ultralight Mirror and Retractor)	108
USC (Amalgam Carves)	125
Universal (Crown Instruments)	135
Universal Scaler (Scalers)	153
USC (Wax and Modeling Carvers)	169
Universal (Universal Pliers)	179

V

Vertical Condenser (Endodontic Instruments)	105
Vickers (Periodonral Instruments)	139

W

Woodward (Root Elevators)	41
Walter F. Barry (Root Elevators)	45
Winter (Root Elevators)	46
Warwick-james (Root Tip Picks)	47
Westcott (Gum Scissors)	56
Williger (Retractors)	74
Williger (Implant Surgery)	84
Williams (Double-Ended Explores)	101
Merrit A (Double-Ended Explores)	101
Merrit B (Double-Ended Explores)	101
Williams (Combination Explorers Probes)	102,103
Ward (Filling Instruments)	119
Westcott (Filling Instruments)	123
Wiland (Amalgam Carves)	125
Wedestaet (Cavity Preparation Instruments)	126
Williger (Periodonral Instruments)	140
Wahl (Bone Files)	142
Ward (Wax and Modelling Carvers)	169
Waldsachs (Universal Pliers)	179
Weingart (Orthodontic Pliers)	181

Y

Young (Mouth Gags - Tongue Forceps)	71
Younger Good (Preiodontal Instruments)	151
Young (Orthodontic Pliers)	185

DENTAL INSTRUMENTS



We Present this Catalogue with the aim of long life commitment and missionary dedication brought the Company, We acquired unblemished of reputation as manufacturers of complete range of Surgical Instruments as per standard set by international medical and surgical organizations.

We have come to specialize in instruments concerning General Surgery or The two vital factors that can darken or illuminate the world of a patient are the dexterity of the surgeons hands & the precision of the instruments involved. As for as the accuracy of the instruments is concerned, we perform our part as conscientiously as is possible by the combination of human hands and the latest available technology.

Service to humanity comes first on our agenda, business and profit is the second.

From the procurement of raw materials to packing, all the phases of the process are conducted under the same roof. This ensures and facilitates our interference at any stage of the process, which makes it possible for us to achieve perfection. Our technical experts can achieve any degree of technicality, ranging from the slightest variations to complete redesigning and production of entirely new items.

The quality of raw materials is of the international standard, but we can also satisfy individual specifications selecting from a large variety of imported steel.

We also welcome enquires for the instruments not listed in this catalogue both in the Surgical Instruments

DIAGNOSTICS SET	03 - 09
SURGICAL HANDLES	10 - 12
STERILE BLADES	13
SKIN GRAFTING KNIVES	14
SCISSORS	15 - 19, 23 - 24
DELICATE SCISSORS	20
ORAL, DELICATE SCISSORS	21
ORAL SCISSORS	22
“TC” SCISSORS	25 - 36
“TC” DISSECTING FORCEPS	37 - 40
TISSUE FORCEPS	41 - 42, 56 - 59, 79
DISSECTING & LIGATURE FORCEPS	43 - 44
SPLINTER FORCEPS	45
TOOTHED DISSECTING FORCEPS	46 - 49
DELICATE DISSECTING FORCEPS	50 - 51
SERRATED DISSECTING FORCEPS	52 - 55
HAEMOSTATS FORCEPS	60 - 66
DRESSING FORCEPS	67
SPONGE HOLDING FORCEPS	68
TOWEL CLAMPS	69
TONGUE DEPRESSORS	70 - 71
NEEDLE HOLDERS	72 - 78
MICRO NEEDLE HOLDERS	80
“TC” NEEDLE HOLDERS	81 - 88
DISSECTORS	89 - 90
PROBES	91 - 92
TROCARS	93
SELF RETAINING RETRACTORS	94 - 101, 103
RETRACTOR	102, 105
HAND HELD RETRACTORS	104, 106 - 120
INTESTINAL CLAMPS	121 - 124
CHOLECYSTECTOMY AND GALL STONE FORCEPS	125
GALL DUCT PROBES	126
CHOLECYSTECTOMY & GALL STONE	127 - 128
VAGINAL SPECULUM	129, 131 - 134
VAGINAL RETRACTOR/UTERINE DILATORS	130
UROLOGY	135 - 139
HAEMORRHOIDAL SYRINGES	140
PROCTOLOGY HAEMORRHOIDAL IGATORS	141
SIGMOIDOSCOPY / BIOSPY	142, 143
PROCTOLOGY	144 - 145
HYSTERECTOMY CLAMPS	146
PERITONEUM INSTRUMENTS	147
OBSTETRICS INSTRUMENTS	148
UTERINE CANNULAE	149
CERVICAL BIOPSY FORCEPS	150 - 152
OVUM FORCEPS	153-154
MALLETS	155 - 156
OSTEOTOMES, CHISELS & GOUGES	157
BONE SCOOPS	158
RASPATORIES	159 - 161
BONE LEVERS	162 - 164
ELEVATORS	164
AMPUTATION INSTRUMENTS	165 - 166
SUCTION TUBES	167 - 168
ATRAUMA CARDIOVASCULAR FORCEPS	169 - 170, 186 - 194, 196
ATRAUMA BULLDOG CLAMPS	171, 195
RIB SPREADERS	172 - 174
BONE & RIB SHEARS	175
PLASTER CAST REMOVAL INSTRUMENTS	176
BONE CUTTING FORCEPS	177
DISC RONGEURS	178
BONE RONGEURS	179 - 181
BONE HOLDING FORCEPS	182
TUNNELING SET	183
VASCULAR DILATORS	184
DILATORS	185

DIAGNOSTICS SET



Set
3001



Set
3002



Set
3003



Set
3004

DIAGNOSTICS SET



Set
3005



Set
3006



Set
3007



Set
3008

DIAGNOSTICS SET



3009



3011



3010



3013



3012



Set
3014



Set
3015



Set
3016

DIAGNOSTICS SET



Set
3017



Set
3018



No.4L
3019



ERGONOMIC
3020



No.7
3021



No. 3
3022

SURGICAL HANDLES



3023



3024



3025



No. 3L
3026



No. 10
3027



No. 4
3028



No. 9
3029



BARRON
3030
For "B.P." type blades
for use with No's 10, 11, 12
& 15 blades
135mm (5.1/4")

STERILE BLADES



3031



3032



3033



3034



3035



3036



3037



3038



3039



3040



3041



3042



SILVER

3043
Skin Graft Knife
without blade
190mm (7.1/2")



WATSON

3044
Skin Graft Knife
without blade
300mm (12")



COBBETT

3045
Skin Graft Knife
without blade
315mm (12.2/3")

SCISSORS



MAYO
Straight, bevelled blades



3046
140 mm
(5.1/2")

3047
190 mm
(7.1/2")



3048
170 mm
(6.3/4")

3049
215mm
(8.1/2")



3050
140 mm
(5.1/2")

3051
190 mm
(7.1/2")



3052
170 mm
(6.3/4")

3053
215mm
(8.1/2")

Curved on flat, bevelled blades



MAYO
Round Blades



3054
170 mm
(6.3/4")

200mm
(8")
Straight



3055
140mm
(5.1/2")

150 mm
(6")
Straight



MAYO
Round Blades



3056
170 mm
(6.3/4")

200mm
(8")
Curved on flat



3057
140mm
(5.1/2")

150 mm
(6")
Curved on flat

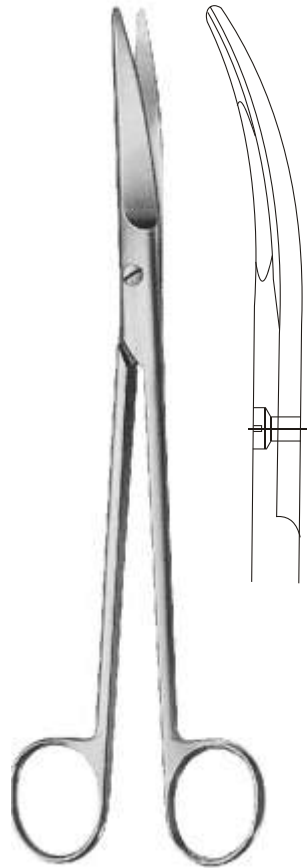

MAYO HARRINGTON
3058
225mm (9")
Curved on flat , blunt points

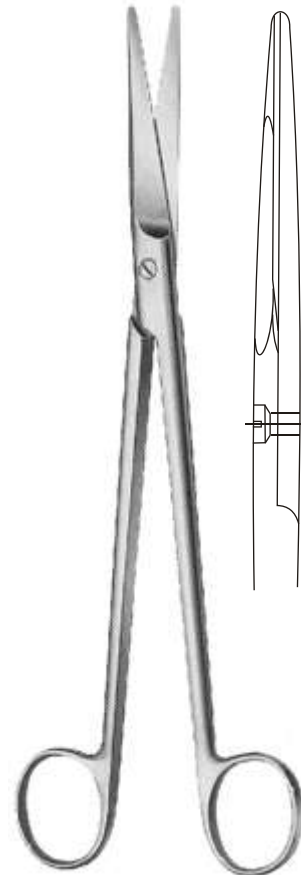

MAYO HARRINGTON
3059
225mm (9")
Straight, blunt points



MAYO (STILLE)

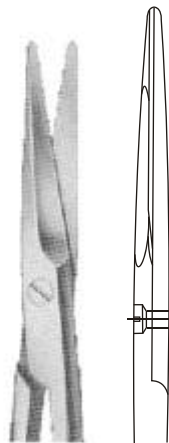

3060
170 mm
(6.3/4")
Straight



3061
150 mm
(6")
Straight



3062
170 mm
(6.3/4")
Curved on
flate

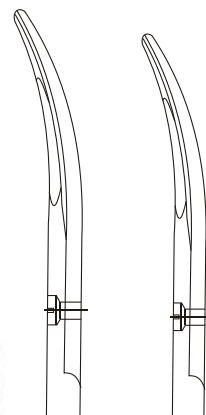

3063
150 mm
(6")
Curved on
flate



METZENBAUM

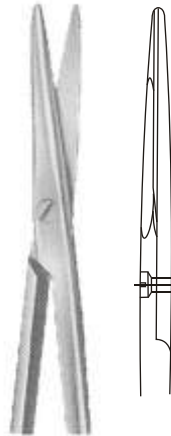

METZENBAUM
Straight, blunt points
3064
115mm (4.1/2")
3065
145mm (5.3/4")
3066
180mm (7")
3067
200mm (8")

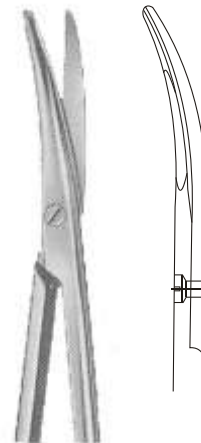

METZENBAUM
Curved on flat, blunt points
3070
115mm (4.1/2")
3071
145mm (5.3/4")
3072
180mm (7")
3073
200mm (8")

METZENBAUM (Nelson)
Straight
3068
230mm (9")
3069
250mm (10")

METZENBAUM (Nelson)
Curved on flat
3074
230mm (9")
3075
250mm (10")

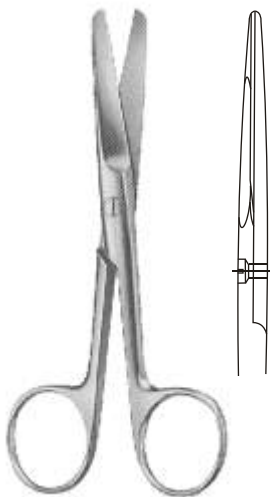

DRESSING
Straight, blunt / blunt points
3076
125mm (5")
3077
145mm (5.3/4")
3078
150mm (6")
3079
180mm ((7")
3080
200mm (8")

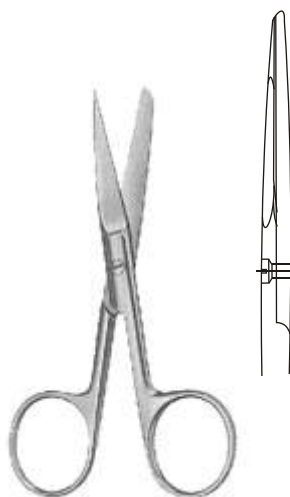

DRESSING
Straight, sharp / blunt points
3081
125mm (5")
3082
145mm (5.3/4")
3083
150mm (6")
3084
180mm ((7")
3085
200mm (8")

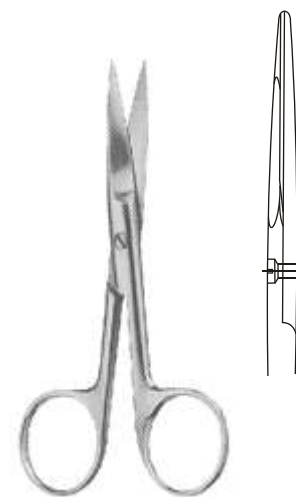

DRESSING
Straight, sharp / Sharp points
3086
125mm (5")
3087
145mm (5.3/4")
3088
150mm (6")
3089
180mm (7")
3090
200mm (8")



CRAFOORD

3091
305mm (12")
Straight

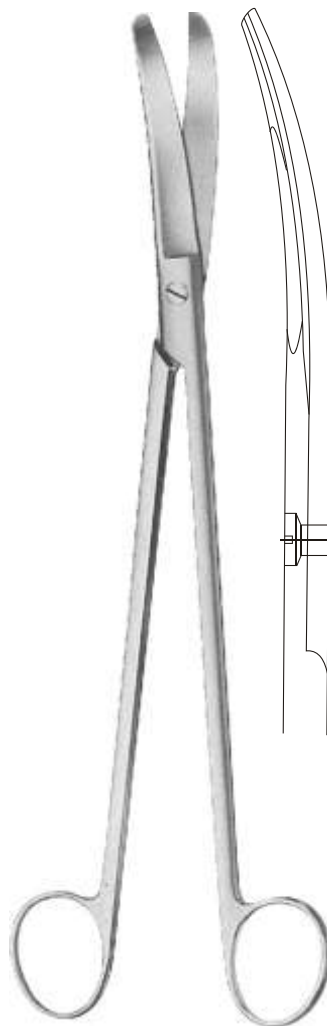

LLOYD DAVIS RECTAL
blunt points, flat blades

3092
255mm (10")
Curved on flat
3093
255mm (10")
Straight

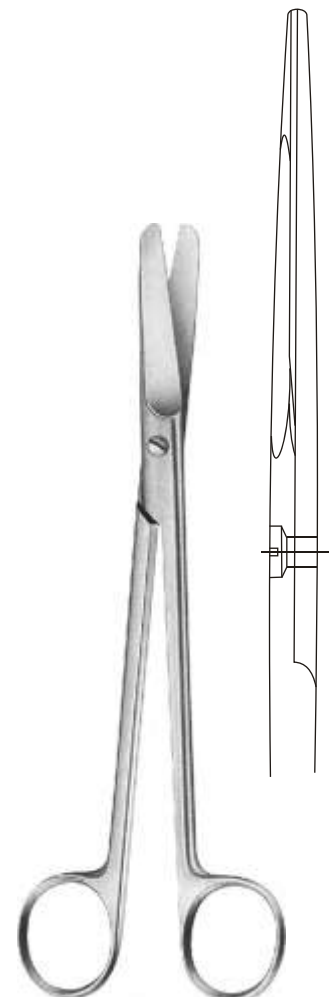

UTERINE

3094
230mm (9")
Straight. blunt points

SCISSORS

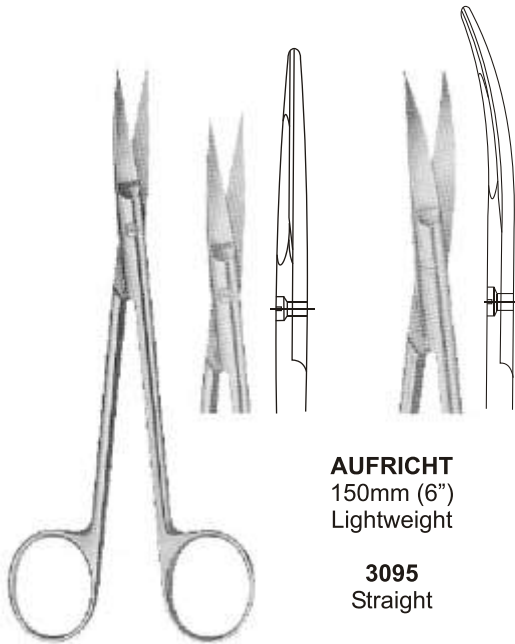

AUFRICHT
150mm (6")
Lightweight

- 3095**
Straight
- 3096**
Curved on flat



KILNER

- 3097**
110mm (4.1/2")
Straight, sharp points
- 3098**
110mm (4.1/2")
Curved on flat, blunt points

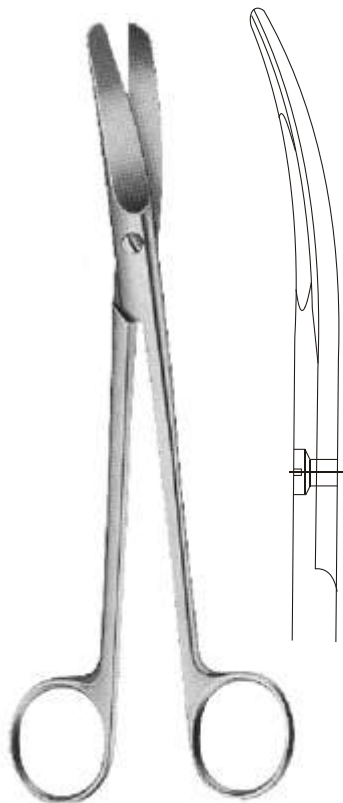

UTERINE
Curved on flat, blunt points

- 3099**
200mm (8")
- 3100**
230mm (9")



**BRAUN STADTLER
EPISIOTOMY**
Angled blades

- 3101**
145mm (5.3/4")
- 3102**
200mm (8")



**AMERICAN PATTERN
UMBILICAL**
Angled blades

- 3103**
100mm (4")

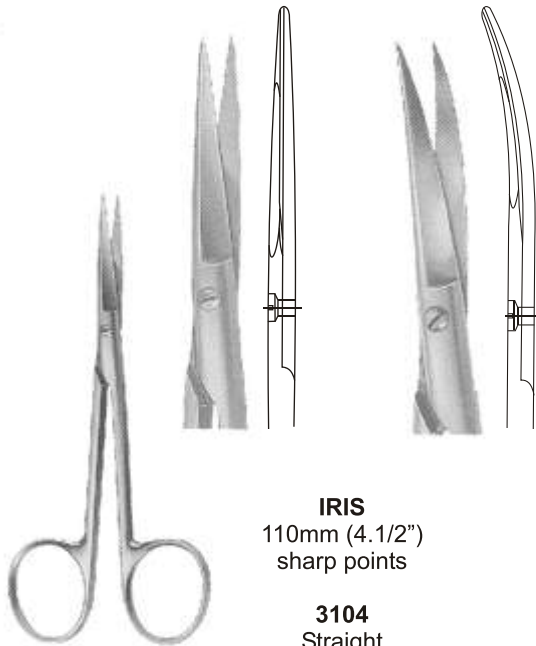

IRIS
110mm (4.1/2")
sharp points

3104
Straight

3105
Curved on flat



IRIS
110mm (4.1/2")
Round blades, sharp points

3106
Straight

3107
Curved on flat

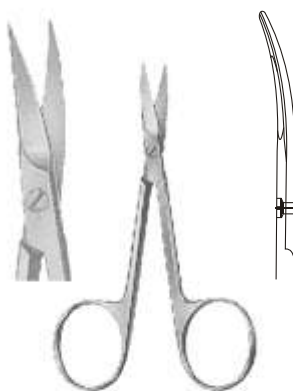

IRIS

3108
90mm (3.1/2")
Curved on flat, lightweight
sharp points

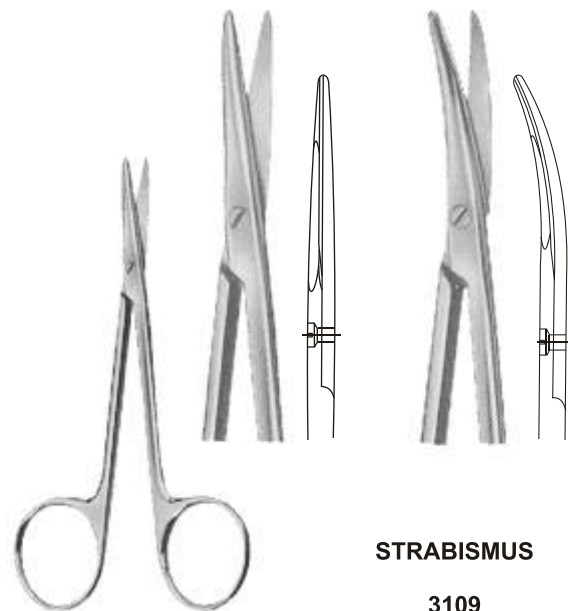

STRABISMUS

3109
110mm (4.1/2")
Straight

3110
110mm (4.1/2")
Curved on flat

ORAL, DELICATE SCISSORS



**SCHUKNECHT
WIRE CUTTING**

3111
125mm (5")



**HEYMANN
TURBINECTOMY**

3112
185mm (7.1/4")
Angled shanks
blunt points



STEVENS TENOTOMY
110 mm (4.1/4")

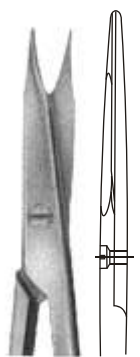

3113
straight,
sharp points

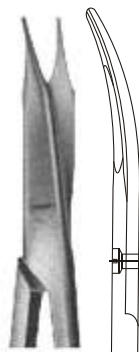

3114
Curved on flat
sharp points

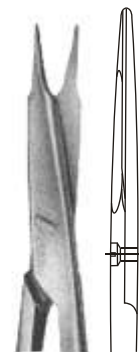

3115
straight,
blunt points

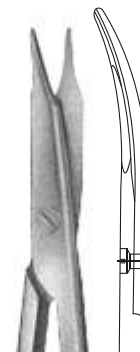

3116
Curved on flat
blunt points



WOODS TONSIL

3117
190mm (7.1/2")
Curved on flat
sharpened
outer edge, blunt

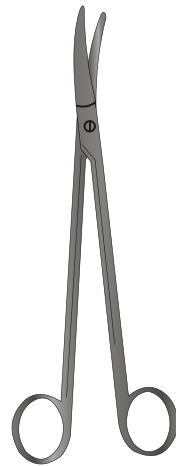

WHEELER TONSIL

3118
200mm (8")
Curved on flat

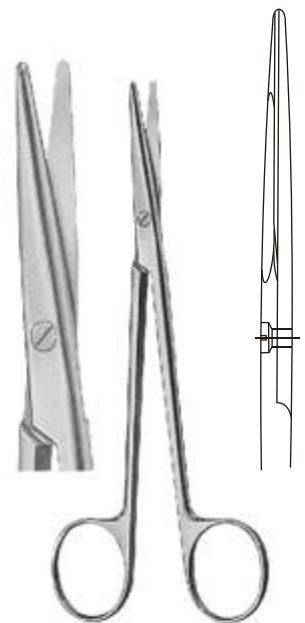

WILSON TONSIL

3119
180mm (7")
Straight

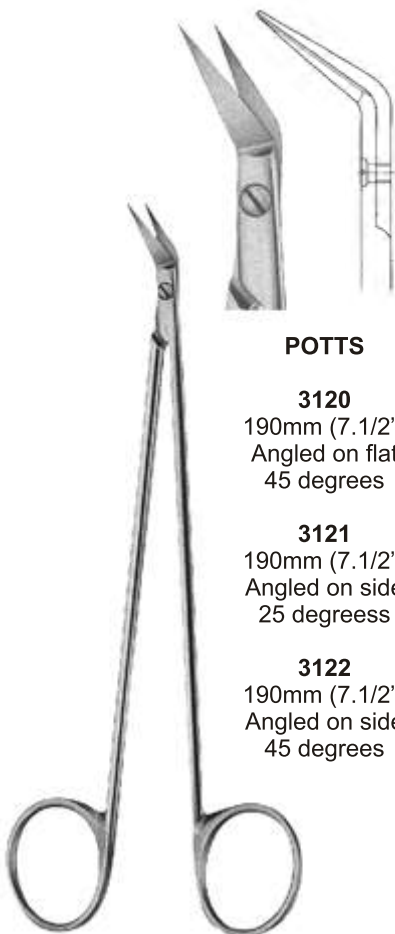

POTTS

3120
190mm (7.1/2")
Angled on flat
45 degrees

3121
190mm (7.1/2")
Angled on side
25 degrees

3122
190mm (7.1/2")
Angled on side
45 degrees

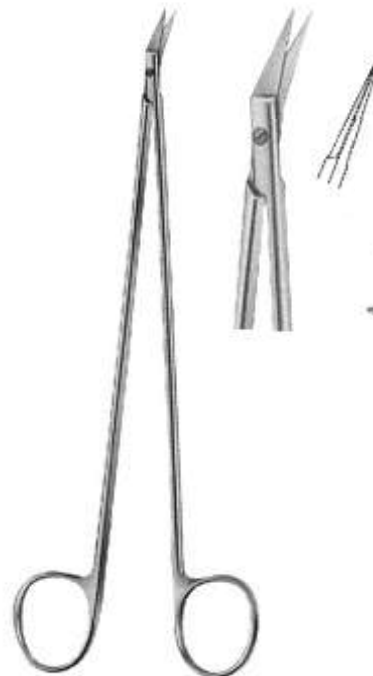

HEDGEMAN (DIETRICH)

3123
175mm (7")
Angled to side, 25 degrees

3124
175mm (7")
Angled to side, 45 degrees

3125
175mm (7")
Angled to side, 60 degrees

3126
175mm (7")
Angled to side, 90 degrees

3127
175mm (7")
Angled to side, 125 degrees



FAVALORO

3128
150mm (6")
Shanks curved,
blades angled to side

SCISSORS

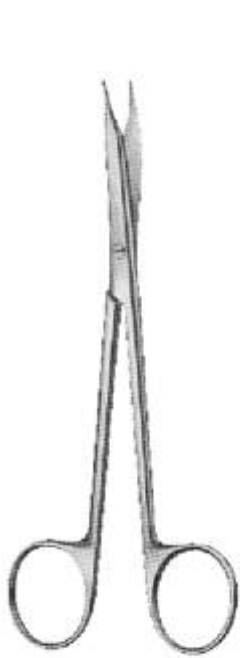

REYNOLDS
Curved on flat, tapered points

3129
145mm (5.3/4")

3130
180mm (7")

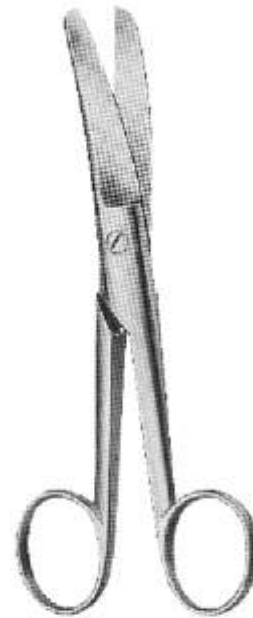
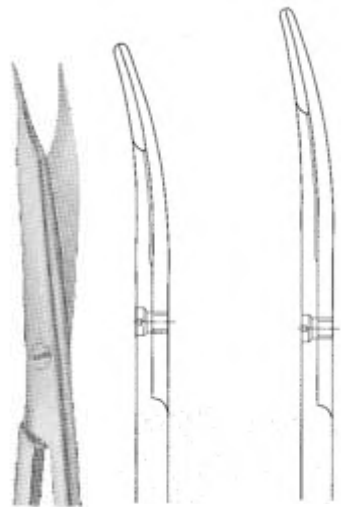

DOYEN ABDOMINAL

3131
180mm (7")
Curved, blunt points

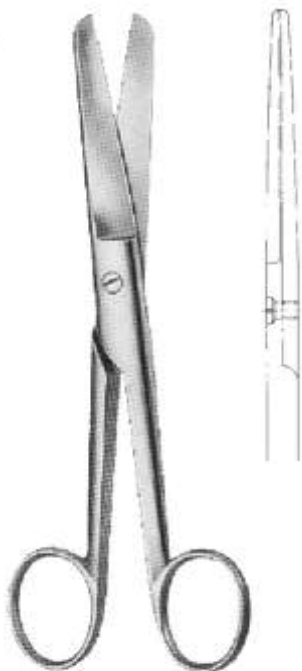

DOYEN ABDOMINAL

3132
180mm (7")
Straight, blunt points

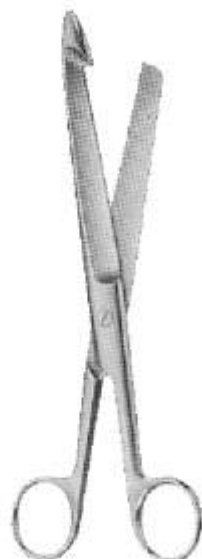

DOYEN ABDOMINAL

3133
210mm (8.1/4")
One blade with hook end



COUNTER SCISSORS

3134
210mm (8.1/4")



LISTER BANDAGE

3135
115mm (4.1/2")

3136
140mm (5.1/2")

3137
180mm (7")

3138
200mm (8")

3139
235mm (9.1/4")



SCHUMACHER UMBILICAL

3140
155mm (6")

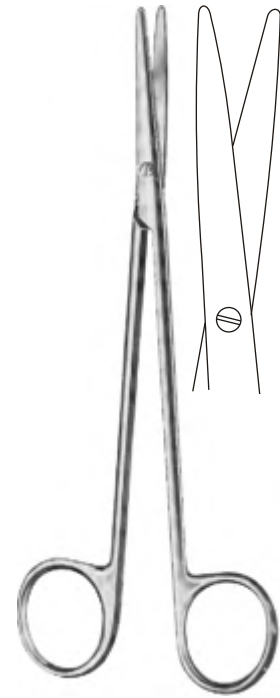

MCINDOE SCISSORS

3141
180mm (7")
Straight

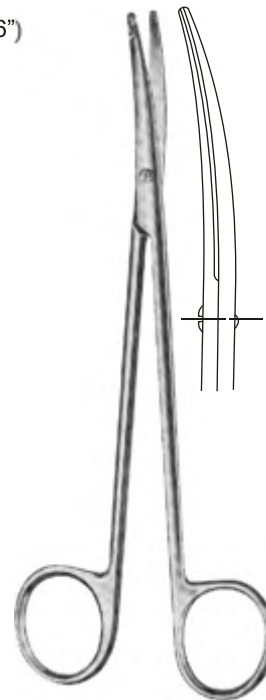

MCINDOE SCISSORS

3142
180mm (7")
Curved

"TC" SCISSORS

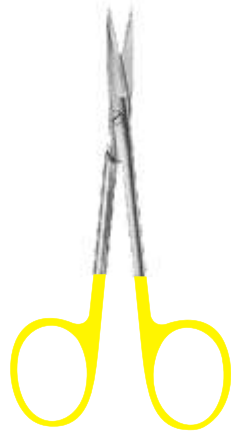

IRIS SCISSORS
110mm (4.3/8")

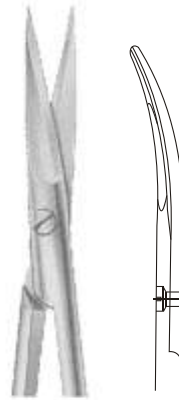

3143

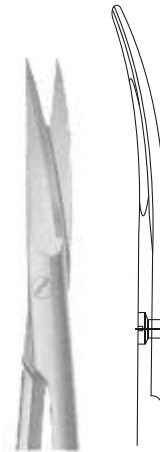

3144

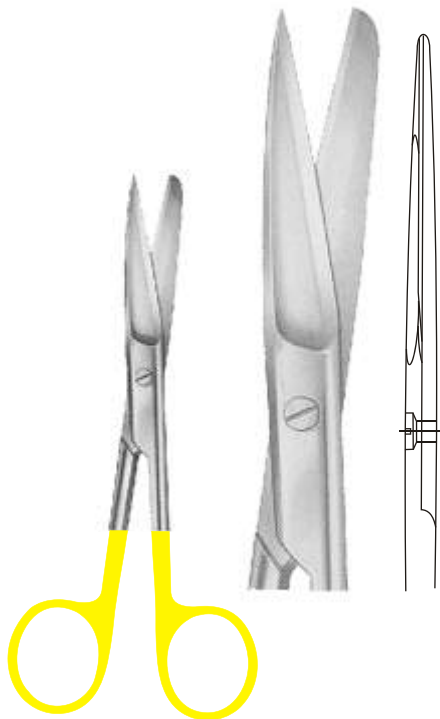

SURGICAL SCISSORS

- 3145**
- 130mm (5")
- 150mm (6")
- 180mm (7")

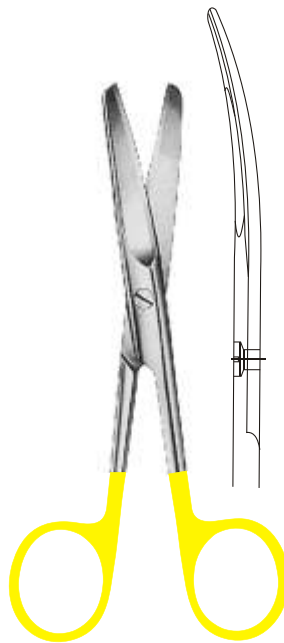

SURGICAL SCISSORS

- 3146**
- 130mm (5")
- 150mm (6")
- 180mm (7")

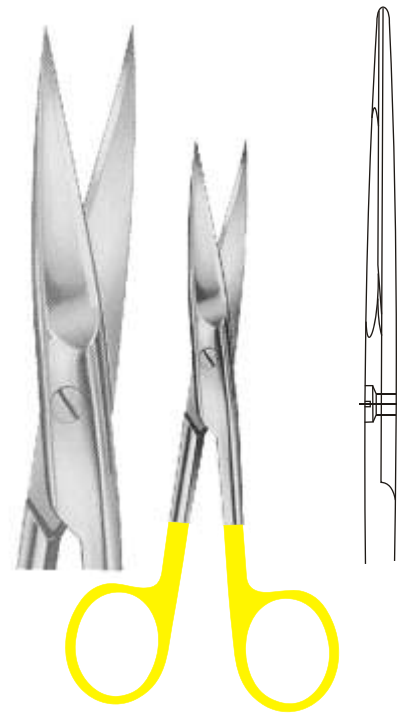

SURGICAL SCISSORS

- 3147**
- 130mm (5")
- 150mm (6")
- 180mm (7")

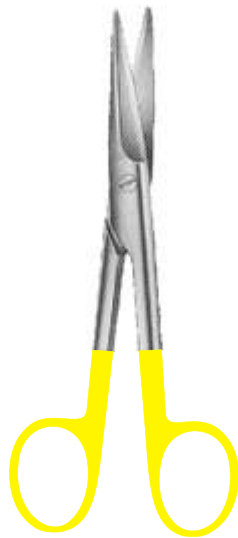

**MAYO
DISSECTING
SCISSORS**



3148
140mm (5.1/2")
150mm (6")
180mm (7")
200mm (8")
230mm (9")

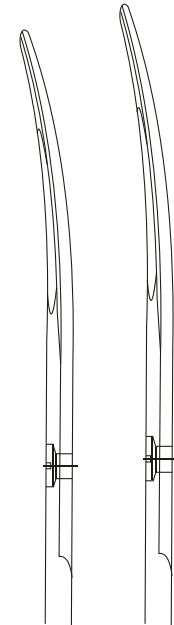

3149
140mm (5.1/2")
150mm (6")
180mm (7")
200mm (8")
230mm (9")

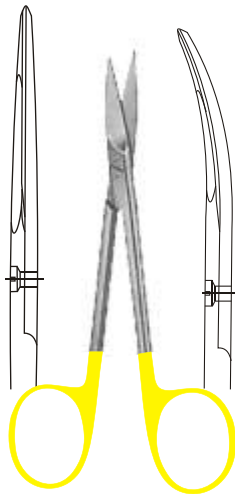

DELICATE SCISSORS
120mm (4.3/4")

3150 Straight

3151 Curved

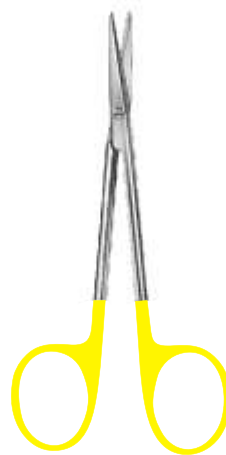

STRABISMUS SCISSORS
115mm (4.1/2")

3152 Straight

3153 Curved

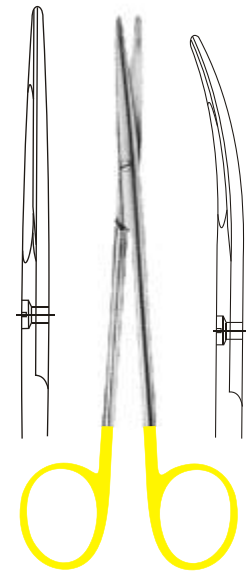

BABY METZANBAUM
145mm (5,3/4")

3154 Straight

3155 Curved

"TC" SCISSORS



METZENBAUM
Round Blade Straight



3156
180mm (7")



3157
145mm (5.3/4")



3158
180mm (7")



3159
200mm (8")



3160
145mm (5.3/4")



3161
180mm (7")



3162
200mm (8")



3163
230mm (9")



3164
180mm (7")



3165
200mm (8")



3166
230mm (9")

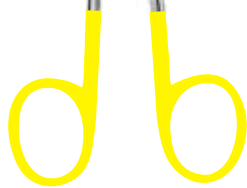
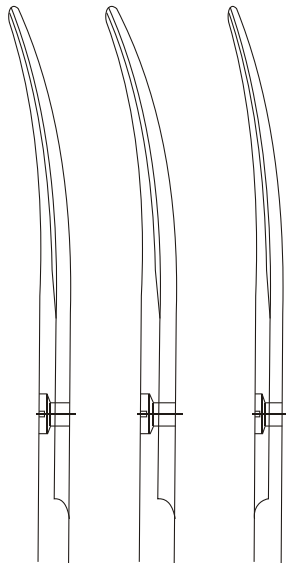

NELSON - METZENBAUM

3167
260mm (10.1/4")

3168
280mm (11")

3169
285mm (11.1/4")

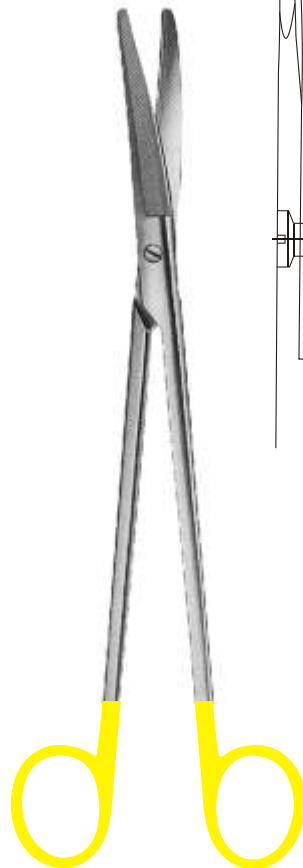

NELSON - METZENBAUM
Dissecting Scissors

3170
230mm (9")

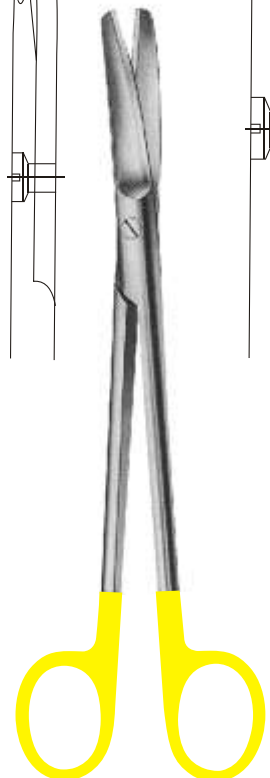
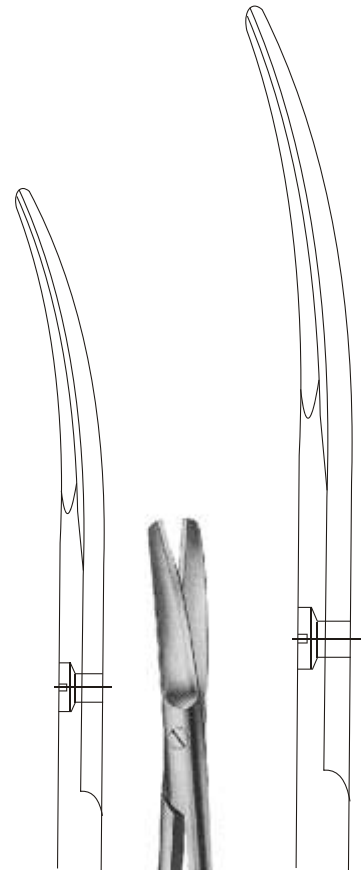

SIMS

3171
200mm (8")

3172
230mm (9")

"TC" SCISSORS

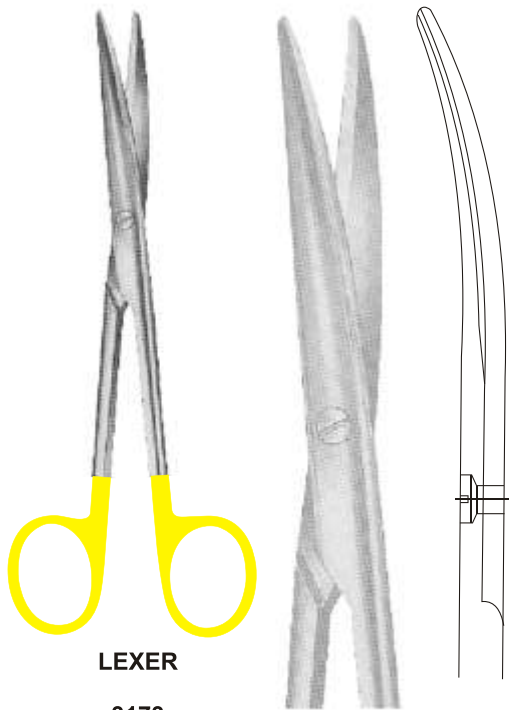

LEXER

3173
165mm (6.1/2")

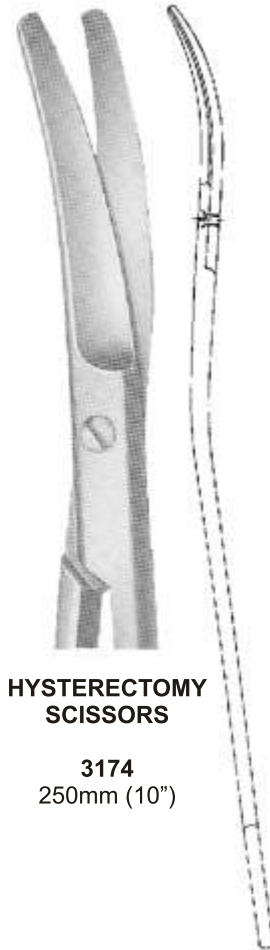

**HYSTERECTOMY
SCISSORS**

3174
250mm (10")

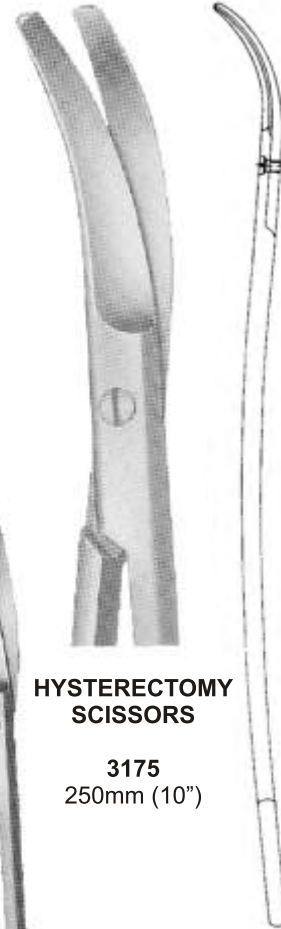

**HYSTERECTOMY
SCISSORS**

3175
250mm (10")

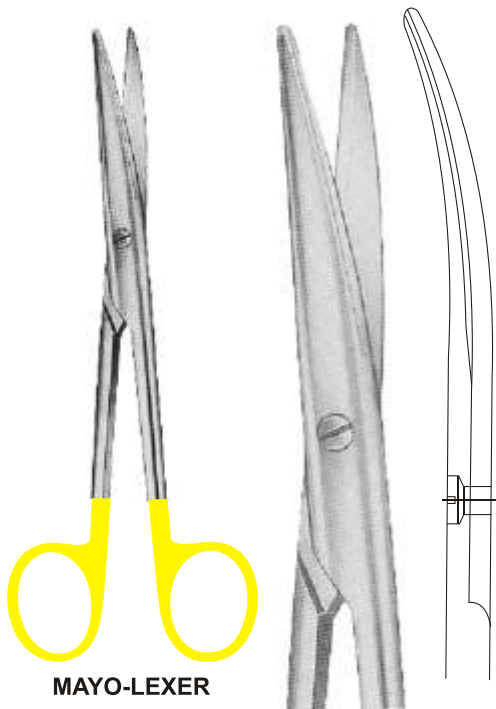

MAYO-LEXER

3176
165mm (6.1/2")

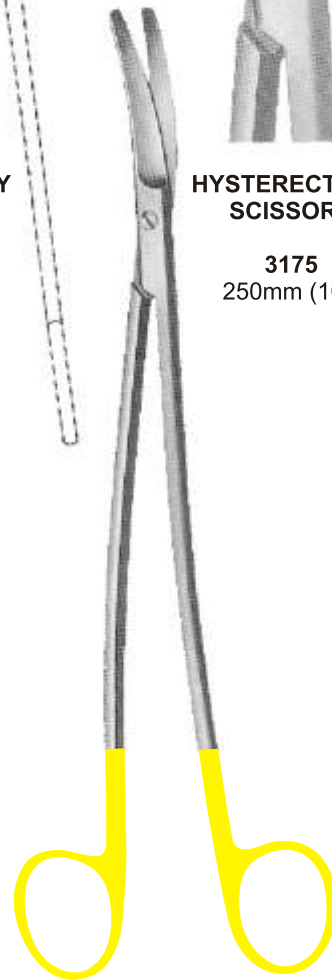

HYSTERECTOMY SCISSORS
Strongly curved to fit with parametriumclamps

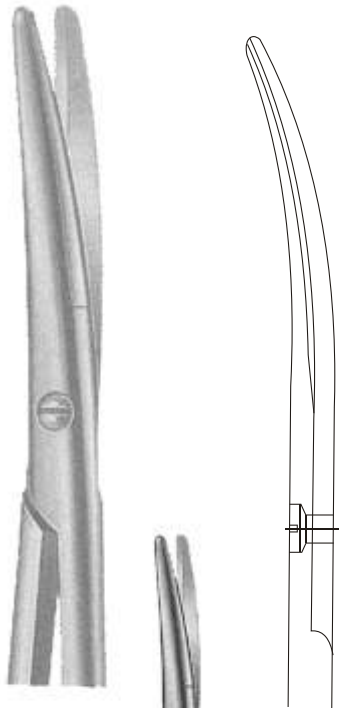

METZENBAUM
3178
230mm (9")
With broad blade ends

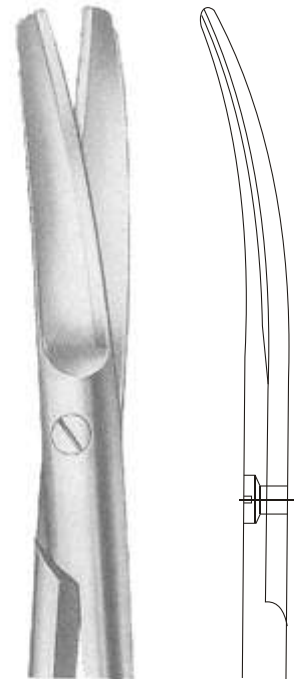

SIMS
3177
200MM (8")



SIMS
3179
230mm (9")

"TC" SCISSORS

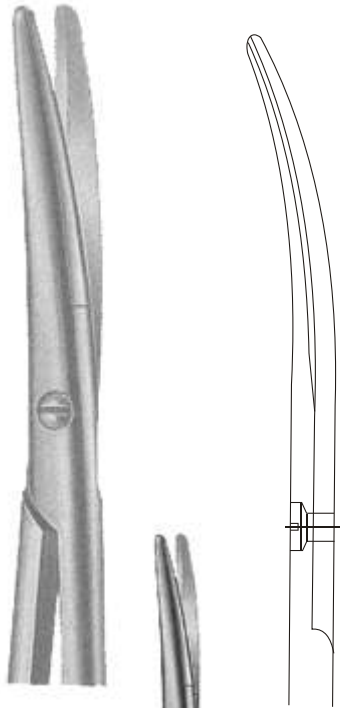

METZENBAUM

3180
230mm (9")
With broad blade ends



SIMS

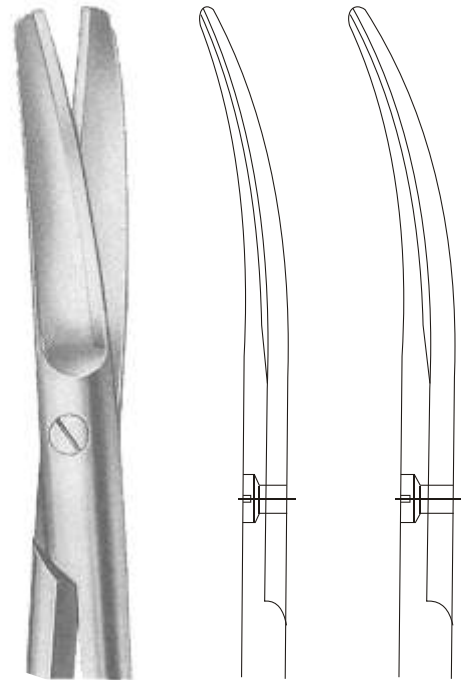

3181 **3182**
200mm (8") 230mm (9")

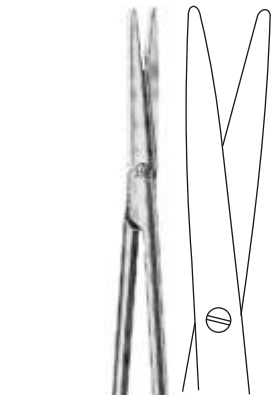

MCINDOE SCISSORS

3183
180mm (7")
Straight

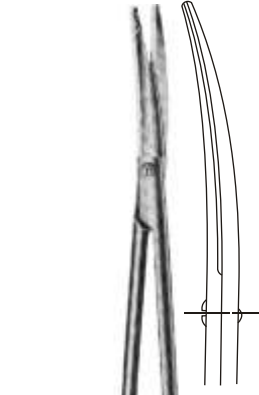

MCINDOE SCISSORS

3184
180mm (7")
Curved

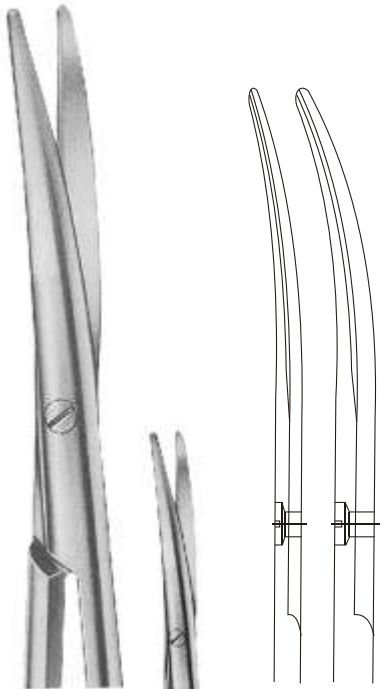

NELSON-METZENBAUM

3185
260mm (10.1/4")

3186
280mm (11")

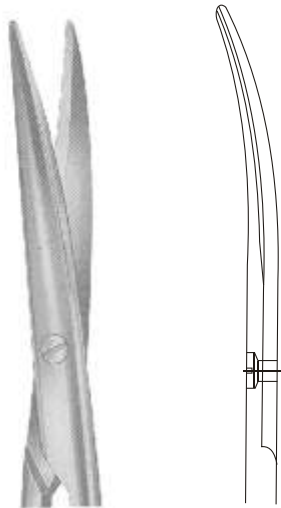

LEXER
Straight

3187
165mm (6.1/2")

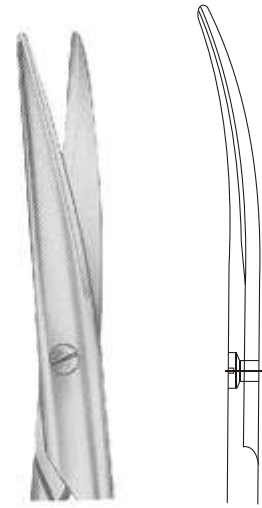

MAYO - LEXER
Curved

3188
165mm (6.1/2")

"TC" SCISSORS

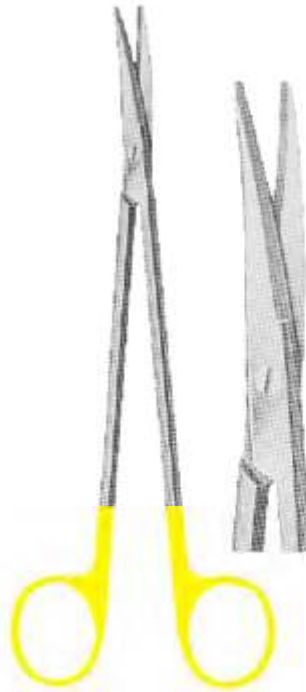
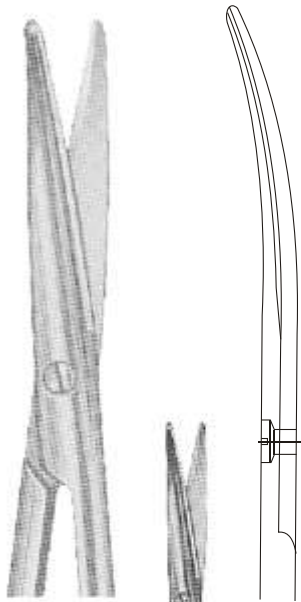

METZENBAUM

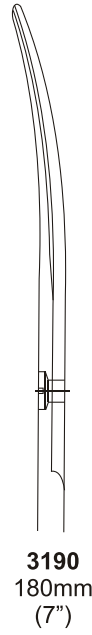

3190
180mm
(7")



3191
200mm
(8")

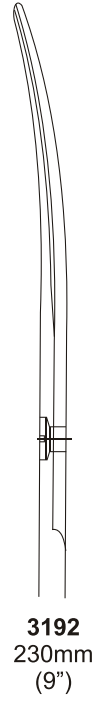

3192
230mm
(9")



NELSON-METZENBAUM

3189
230mm (9")



TOENNIS ADSON

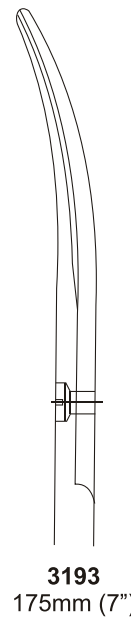

3193
175mm (7")

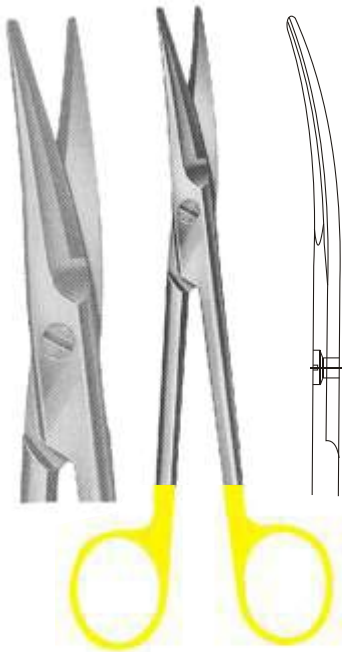

MAYO

3194
170mm (6.3/4")
Dissecting Scissors

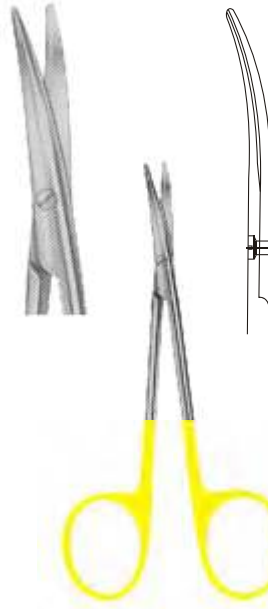

METZENBAUM DELICATE

3195
115mm (4.1/2")

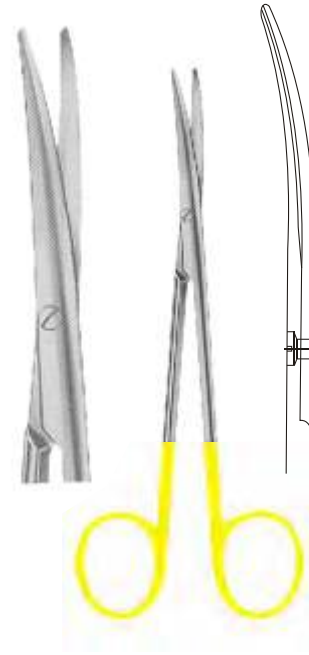

BABY METZENBAUM

3196
145mm (5.3/4")
3197
180mm (7")
3198
200mm (8")



METZENBAUM

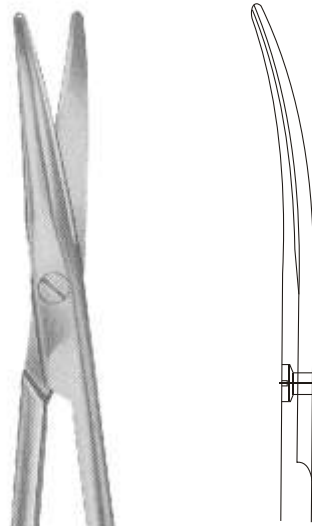

3199
145mm (5.3/4")



3200
180mm (7")



3201
200mm (8")

"TC" SCISSORS



**DEBAKEY
VASCULAR SCISSORS**

3202
220mm (8.3/4")



3203
Sharp Point
130mm (5.1/8")
1 blad serrated



IRIS DELICATE

3205
110mm (4.3/8")



3204
120mm (4.3/4")
Wire cutting scissors
1 blade serrated



DRESSING SCISSORS

3206
145mm (5.3/4")



3207

REYNOLDS SCISSORS
150mm (6")
180mm (7")

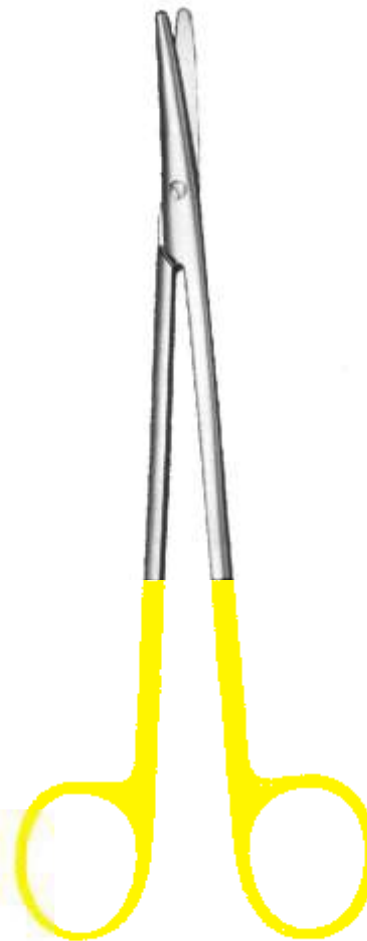

3208

METZENBAUM
Straight
145mm (5.3/4")
180mm (7")
200mm (8")

Curved
145mm (5.3/4")
180mm (7")

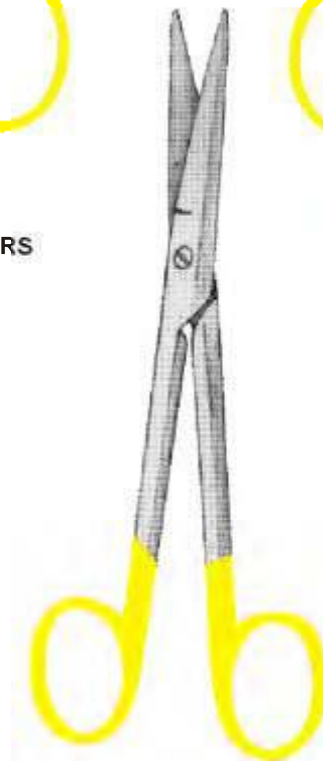

3209

MAYO
140mm (5.1/2")

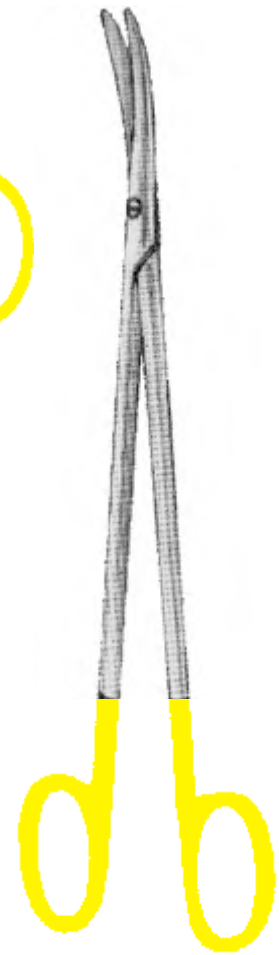

3210

McIndoe
190mm (7.1/4")

"TC" DISSECTING FORCEPS

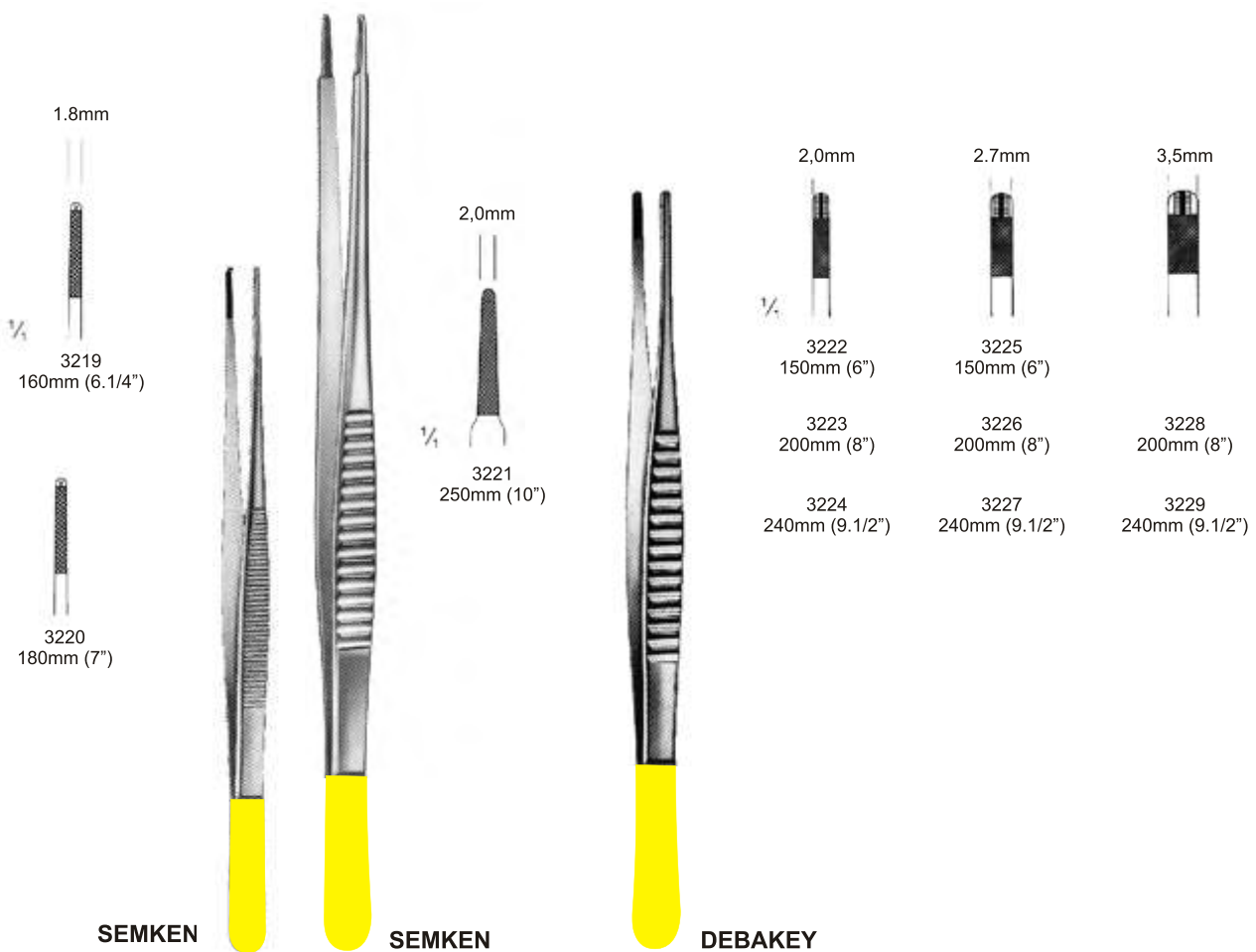
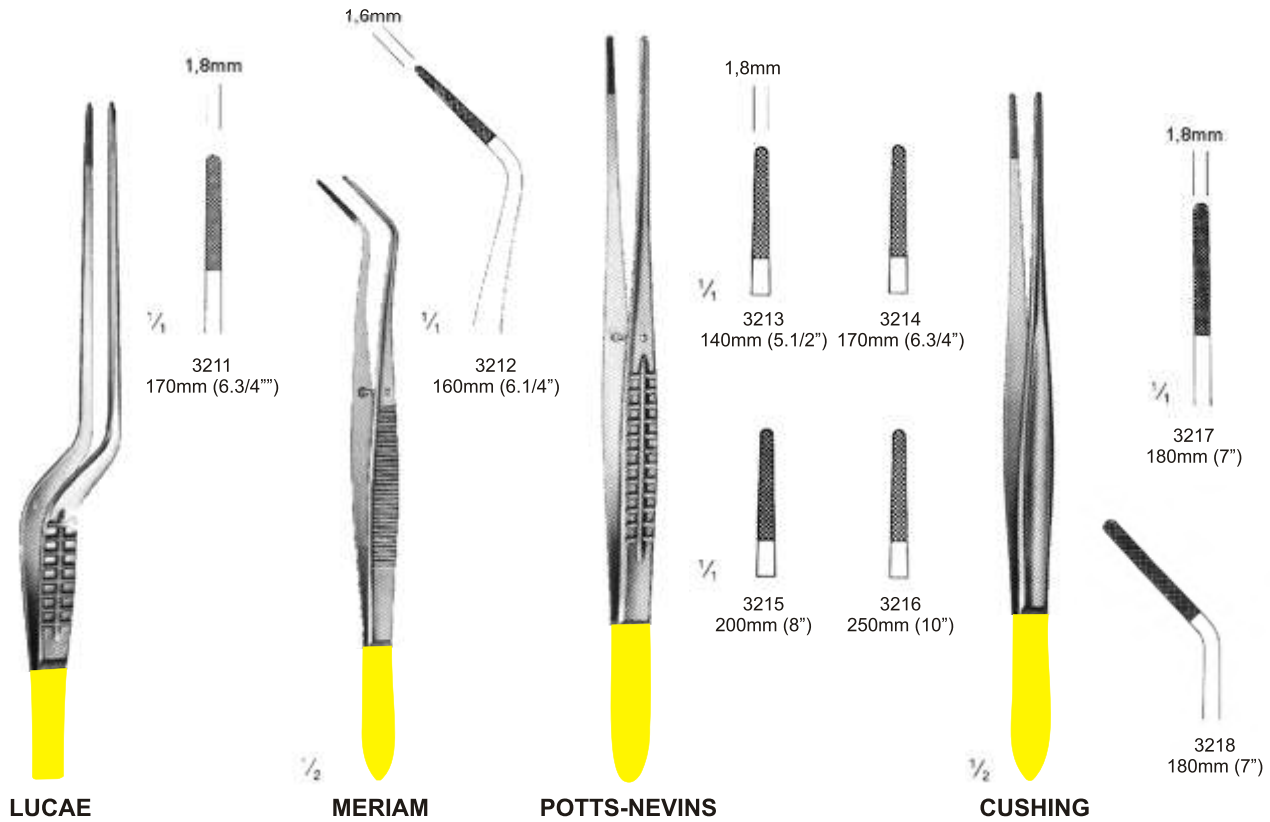

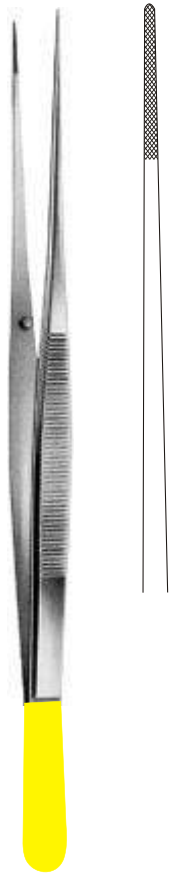

3230
230mm (9")



3231
185mm (7.1/4")

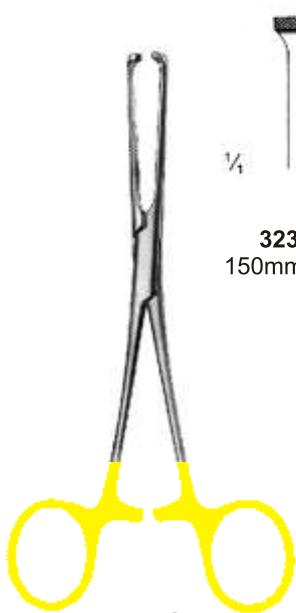

3232
150mm (6")

ALLIS



3233
190mm (7.1/2")

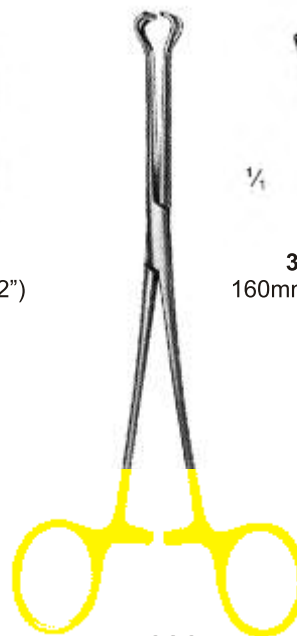

3234
160mm (6.1/4")

BABCOCK



3235
200mm (8")

"TC" DISSECTING FORCEPS



3236
145mm
(5.3/4")



3237
180mm
(7")



3238
200mm
(8")



3239
250mm
(10")



WANGENSTEEN



3240
150mm
(6")



3241
230mm
(9")

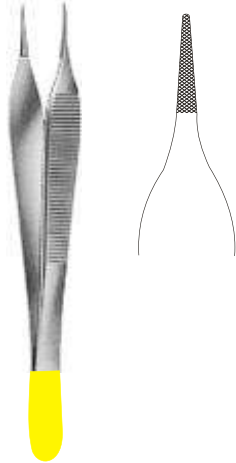

ADSON

3242
120mm (4.3/4")

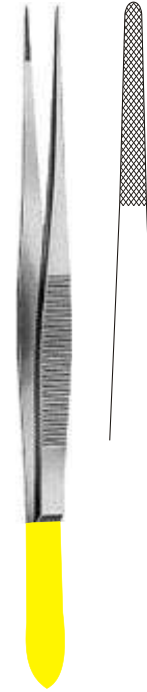

CUSHING

3243
180mm (7")
With scraper end



3244
145mm
(5.3/4")



3245
200mm
(8")



3246
250mm
(10")

TISSUE FORCEPS

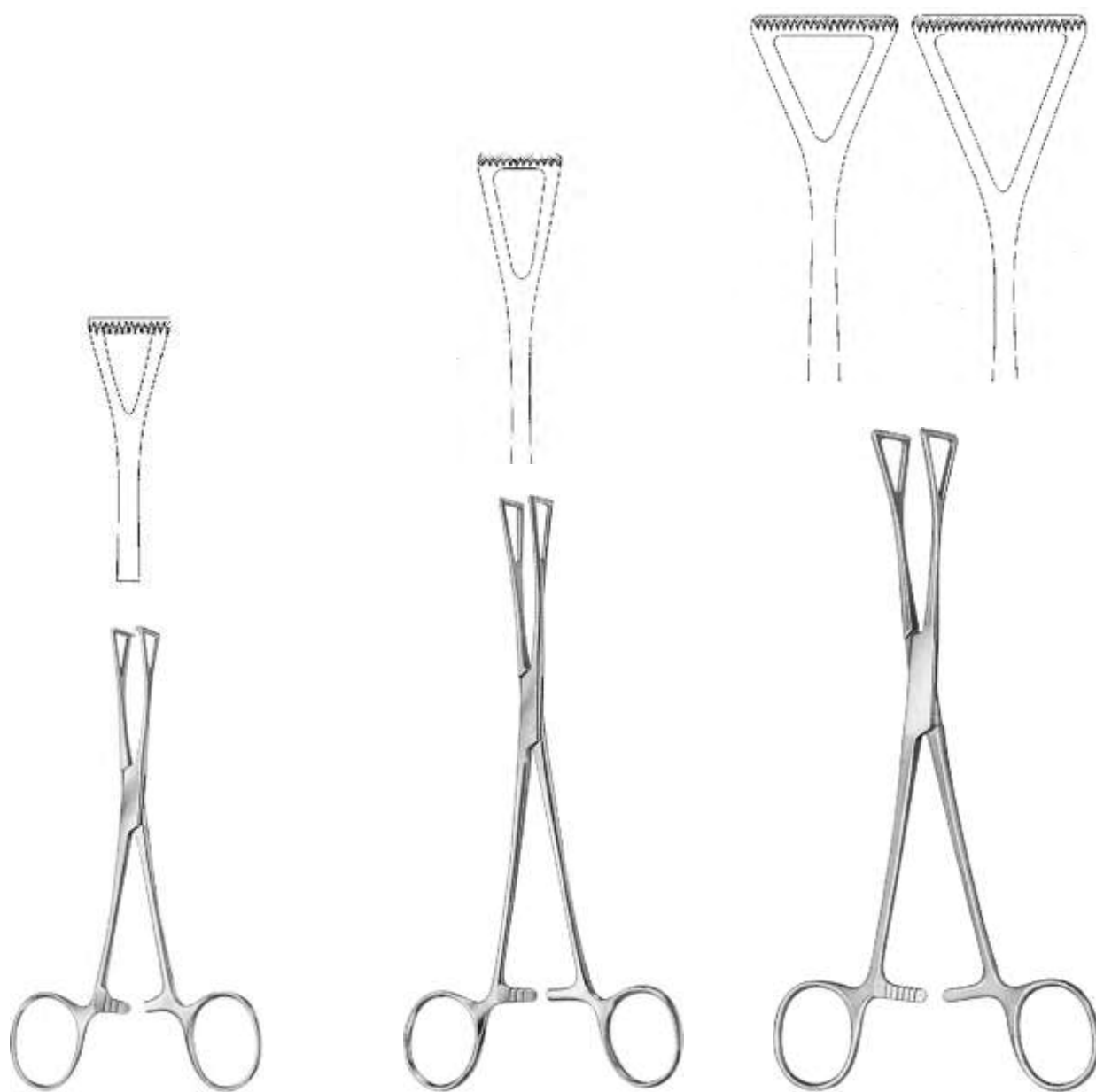

DUVAL

3247
140mm (5.1/2")

DUVAL

3248
180mm (7")

DUVAL

3249
190mm (7.1/2")

3250
200mm (8")



RUTHERFORD MORISON

3251
150mm (6")
6 x 7 teeth



STILES (ALLIS-THOMS)

3252
200mm (8")
6 x 7 teeth



LANE

1 x 2 teeth fenestrated

3253
125mm (5")

3254
150mm (6")

DISSECTING & LIGATURE FORCEPS



3255
215mm (8.1/2")



3256
210mm (8.1/4")



3257
220mm (8.3/4")



3258
225mm (9")



3259
225mm (9")



**FINE CURVED DISSECTING
FORCEPS**



3260
295mm (11.3/4")



3261
295mm (11.3/4")



3262
300mm (12")



LIGATURE FORCEPS
3263
95mm (3.3/4")
Straight, smooth jaw



MICRO ADSON
3264
140mm (5.1/2")



3265
185mm (7.1/4")



3266
210mm (8.1/4")



BABY - ADSON



3267
140mm
(5.1/2")



3268
180mm
(7")



S.SHAPED DELICATE

SPLINTER FORCEPS



3269
ARTHURE
140mm (5.1/2")



3270
FEILCHENFEL
70mm (3")
90mm (3.1/2")
115mm (4.1/2")



3271
HUNTER
105mm (4.1/8")



3272
DENIS BROWNE
190mm (7.1/2")



3273
MICRO SOFT TOUCH RING TIP
150mm (6")
3274
185mm (7.1/4")
3275
210mm (8.1/4")
3276
230mm (9")
3277
250mm (10")



3278
TROELTSCH (Wilde)
110mm (4.1/2")



3279
TROELTSCH (Wilde)
120mm (4.3/4")
1 x 2 teeth



3280
TUDICHUM
65mm (23.1/2")

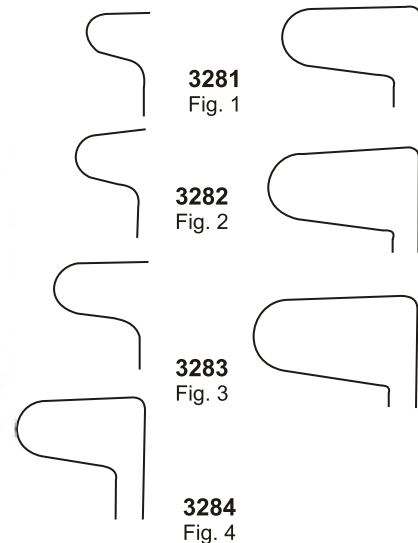

3281
Fig. 1

3282
Fig. 2

3283
Fig. 3

3284
Fig. 4



3285



3288

SILCOCK
1 x 2 teeth
3286
100mm (4")
3287
110mm (4.3/8")



3289



3292

FINE
1 x 2 teeth
3290
100mm (4")
3291
100mm (4")



3293



3294



RAMSEY
180mm (7")



BONNEY
1 x 2 teeth
3295
180mm (7")



BICKFORD
1 x 2 teeth
3296
225mm (9")



CANADIAN
2 x 3 teeth
3297
140mm (5.1/2")
3298
150mm (6")

TOOTHED DISSECTING FORCEPS



WAUGH
1 x 2 teeth

3299
200mm (8")

3300
180mm (7")

3301
150mm (6")

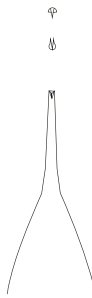

ADSON
1 X 2 teeth

3302
125mm (5") Fine

3303
125mm (5") Standard

3304
190mm (7.1/2")



ADSON
Bayonet
1 x 2 teeth

3305
190mm (7.1/2")



JEFFERSON
1 x 2 teeth

3306
180mm (7")



ADSON-BROWN
7 x 7 teeth

3307
125mm (5")



PENNYBACKER
3 x 4 teeth

3308
160mm (6.1/2")

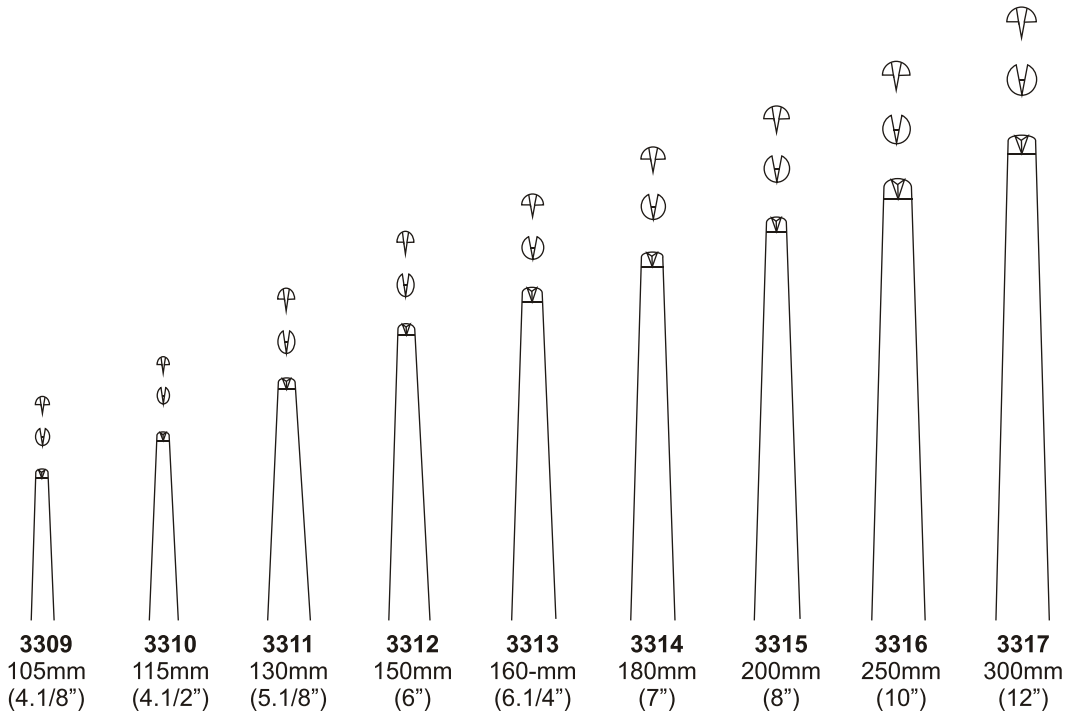

3309 105mm (4.1/8")	3310 115mm (4.1/2")	3311 130mm (5.1/8")	3312 150mm (6")	3313 160mm (6.1/4")	3314 180mm (7")	3315 200mm (8")	3316 250mm (10")	3317 300mm (12")
----------------------------------	----------------------------------	----------------------------------	------------------------------	----------------------------------	------------------------------	------------------------------	-------------------------------	-------------------------------

DISSECTING FORCEPS

1 x 2 teeth

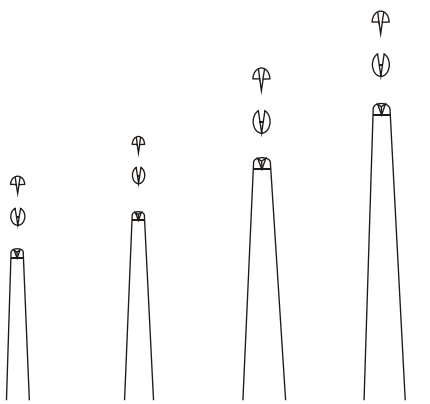

3318 115mm (4.1/2")	3319 130mm (5.1/8")	3320 145mm (5.3/4")	3321 160mm (6.1/4")
----------------------------------	----------------------------------	----------------------------------	----------------------------------



GILLIES
3322
150mm (6")
1 x 2 teeth



MICINDOE
3323
150mm (6")
1 x 2 teeth



TOOTHED DISSECTING FORCEPS



TREVES
1 x 2 teeth

3324
125mm (5")

3325
150mm (6")

3326
180mm (7")

3327
200mm (8")

3328
250mm (10")



LANE
1 x 2 teeth

3329
125 mm (5")

3330
145mm (5.3/4")

3331
180mm (7")

LANE
2 x 3 teeth

3332
145mm (5.3/4")

3333
180mm (7")



DISSECTING FORCEPS

3334
150mm (6")
2 x 3 teeth

3335
150mm (6")
3 x 4 teeth



ADSON

3336
125mm (5") Fine

3337
125mm (5") Standard

3338
190mm (7.1/2")



CAIRNS (DOTT)

3339
215mm (8.1/2")
Medium jaw
2mm wide

3340
180mm (7")
Fine jaw
1mm wide



JEFFERSON

3341
180mm (7")



SILCOCK

3342
100mm (4")



EXTRA FINE
100mm (4")



3343



3344

DELICATE DISECTING FORCEPS



3345
90mm
(3.1/2")



3346
105mm
(4.1/8")



3347
115mm
(4.1/2")

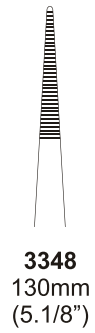

3348
130mm
(5.1/8")

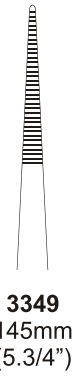

3349
145mm
(5.3/4")



3350
90mm
(3.1/2")



3351
105mm
(4.1/8")



3352
115mm
(4.1/2")



3353
130mm
(5.1/8")

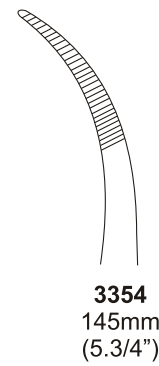

3354
145mm
(5.3/4")

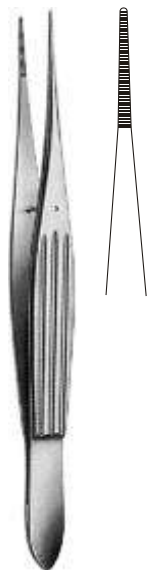

MACINDOE
3355
150mm (6")



WAUGH
3356
200mm (8")



WAUGH



3357
150mm (6")

3358
180mm (7")



MAINGOT INTESTINAL
Fenestrated Grip

3359
280mm (11")



ST MARKS

3360
290mm (11.1/2")



EMMET

3361
200mm (8")

SERRATED DISSECTING FORCEPS



RAMSEY

3362
180mm (7")



BONNEY

3363
180mm (7")



BICKFORD

3364
225mm (9")



**DISSECTING
FORCEPS**



3365
115mm
(4.1/2")



3366
130mm
(5.1/8")



3367
145mm
(5.3/4")



3368
160mm
(6.1/4")



3369
305mm
(12")



**DISSECTING
FORCEPS**



3370
150mm
(6")



3371
180mm
(7")



3372
200mm
(8")

SERRATED DISSECTING FORCEPS



CANADIAN
Straight

3373
130mm (5.1/8")

3374
150mm (6")



DISSECTING FORCEPS
Turn over end

3375
125mm (5")

3376
150mm (6")

3377
180mm (7")

3378
200mm (8")

3379
250mm (10")



DISSECTING FORCEPS
Block end

3380
125mm (5")

3381
150mm (6")

3382
180mm (7")

3383
200mm (8")

3384
250mm (10")



LITTLEWOOD

3385
185mm (7.1/4")
2 x 3 teeth



TUBING CLAMP

3386
175mm (7")

3387
200mm (8")



CHAPUT (POIRIER)

3389
125mm (5")
2 x 3 teeth

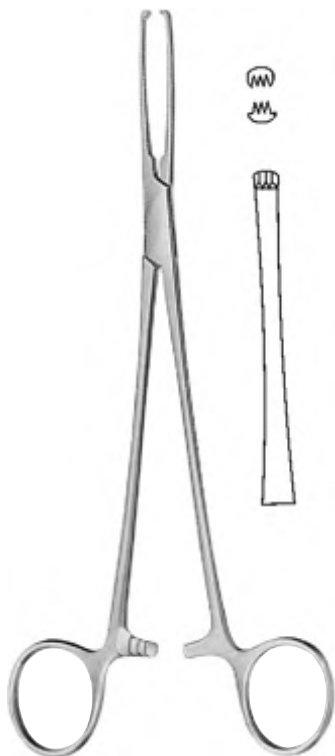

JUD-ALLIS

3388
195mm (7.3/4")
Light pattern, 3 x 4 teeth



LITTLEWOOD

3390
185mm (7.1/4")
2 x 3 teeth



JUD-ALLIS

3391
195mm (7.3/4")
Light pattern, 3 x 4 teeth



CHAPUT (POIRIER)

3392
125mm (5")
2 x 3 teeth

TISSUE FORCEPS

ALLIS
150mm (6")

3393
2 x 3 teeth

3394
3 x 4 teeth

3395
4 x 5 teeth

3396
5 x 6 teeth

3397
6 x 7 teeth

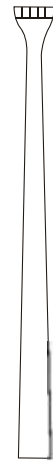

3401



3402



AMERICAN PATTERN ALLIS

3398
150mm (6")
3 x 4 teeth

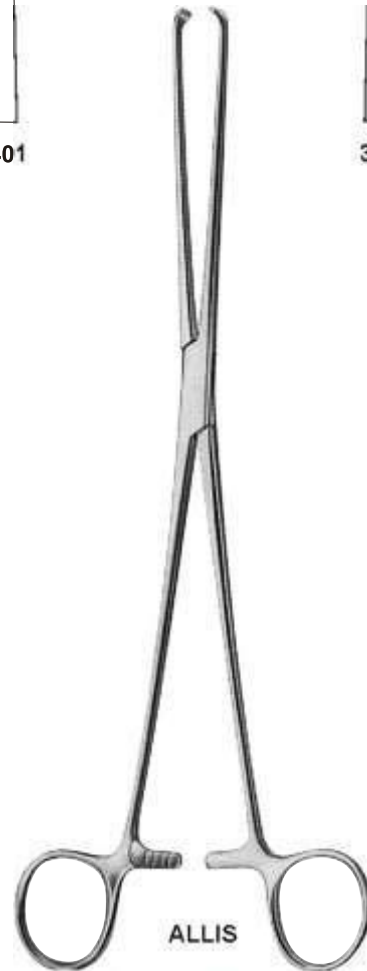

ALLIS

3399
190mm (7.1/2")

3400
255mm (10")
5 x 6 Teeth



3403
125mm
(5")



3404
150mm
(6")



3405
180mm
(7")



3406
200mm
(8")



3407
225mm
(9")



SPENCER WELLS
Straight



3408
125mm
(5")



3409
150mm
(6")



3410
180mm
(7")



3411
200mm
(8")



3412
225mm
(9")

SPENCER WELLS
Curved on flat

HAEMOSTATS FORCEPS



FRASER-KELLY (CRILE)

3413
180mm (7")
Curved on flat



3414
180mm (7")
Curved on flat



3415
180mm (7")
Straight



3416
185mm (7.1/4")
Curved on flat
1 x 2 teeth



3417
185mm (7.1/4")
Straight
1 x 2 teeth



FRASER - ADSON



DUNHILL

3418
125mm (5")
Curved on flate

3419
125mm (5")
Straight

3420
180mm (7")
Curved on flat



KOCHER
Curved on flat 1 x 2 teeth

3421
125mm (5")

3422
140mm (5.1/2")

3423
150mm (6")

3424
180mm (7")

3425
200mm (8")

3426
225 (9")



LLOYD DAVIS

3427
260mm (10.1/4")
Curved on flat



MAYO

3428
160mm (6.1/4")
Curved on flat



KELLY
Curved on flat

3429
140mm (5.1/2")

3430
160mm (6.1/4")



KOCHER
Straight 1 x 2 teeth

3431
125mm (5")

3432
140mm (5.1/2")

3433
150mm (6")

3434
180mm (7")

3435
200mm (8")

3436
225mm (9")



KELLY HALSTEAD

3437
140mm (5.1/2")
Straight

3438
140mm (5.1/2")
Curved on flat



CAIRNS

3439
145mm (5.3/4")

3440
145mm (5.3/4")
Curved on flat

3441
145mm (5.3/4")
Curved to side



CRAFOORD

3442
254mm (9.3/4")
Curved on flat



CRILE
Straight

3443
140mm (5.1/2")

3444
160mm (6.1/4")

3445
180mm (7")

HAEMOSTATS FORCEPS



BABY-CRILE

3446
140mm (5.1/2")
Curved on flat



BABY-CRILE

3447
140mm (5.1/2")
Straight
1 x 2 teeth



BABY CRILE

3448
140mm (5.1/2")
Curved on flat
1 x 2 teeth



HALSTEAD MOSQUITO
125mm (5")

3449
Straight
3450
Curved on flat

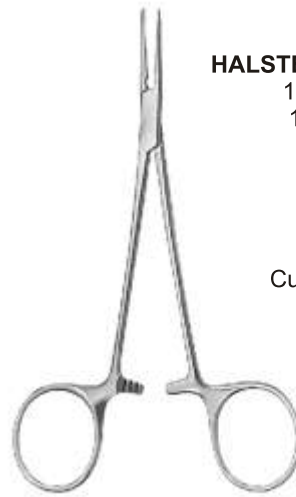

HALSTEAD MOSQUITO
125mm (5")
1 x 2 teeth

3451
Straight
3452
Curved on flat



HALSTEAD MOSQUITO

3453
100mm (4")
Straight



HALSTEAD MOSQUITO

3454
100mm (4")
Curved on flat



HALSTEAD MOSQUITO

100mm (4")
1 x 2 teeth

3455
Straight

3456
Curved on flat



HALSTEAD MOSQUITO

125mm (5")

3457
Straight

3458
Curved on flat



HALSTEAD MOSQUITO

125mm (5")
1 x 2 teeth

3459
Straight

3460
Curved on flat



BABY - CRILE

3461
140mm (5.1/2")
Straight

DRESSING FORCEPS

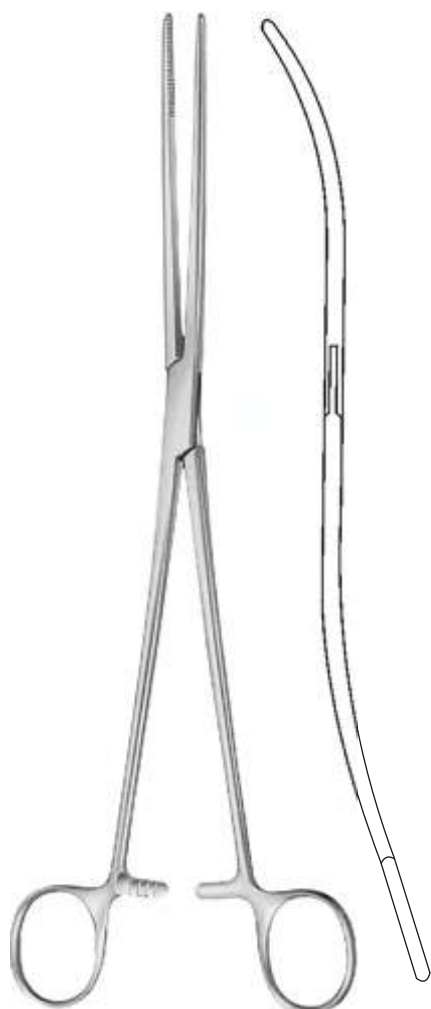

BOZEMANN
3462
250mm (10")
S-shaped curve



BOZEMANN
3463
260mm (10.1/4")
Straight

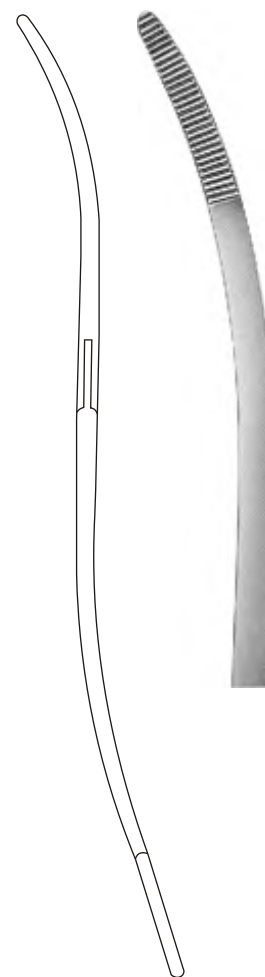

3464
250mm (10")
Curved



RAMPLEY

3465
180mm (7")

3466
240mm (9.1/2")



FORESTER

3467
240mm (9.1/2")

3468
180mm (7")
Straight

3469
240mm (9.1/2")

3470
180mm (7")
Curved on flat

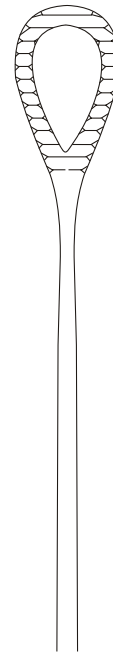

3471

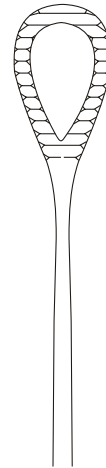

3472

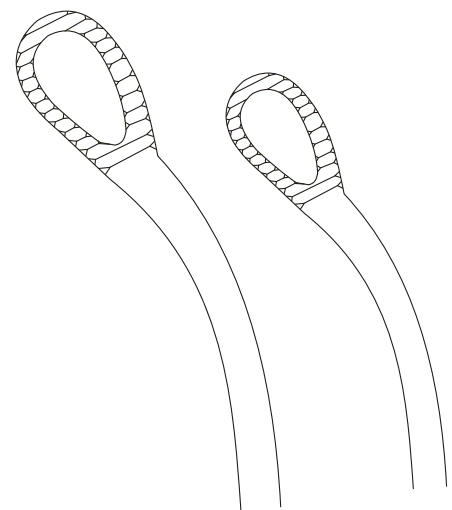

3473

3474

TOWEL CLAMPS



BALL AND SOCKET

3475
130mm (5")



BACKHAUS

3476
90mm (3.1/2")



3477
100mm (4.3/4")



3478
135mm (5.1/4")

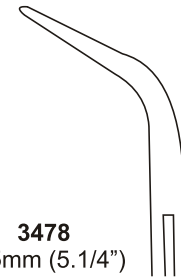

MAYO

3479
140mm (5.1/2")



MOYNIHAN

3480
190mm (7.1/2")
2 x 2 teeth

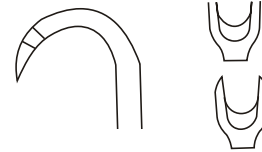



3483



3484



COLLIN TONGUE FORCEPS

3481
170mm (6.3/4")

3482
160mm (6.1/4")



HEYWOOD-SMITH TONGUE FORCEPS

3485
200mm (8")

TONGUE DEPRESSORS

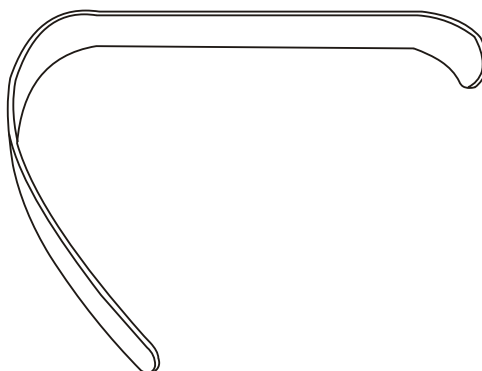

LACK TONGUE DEPRESSOR

3486

13mm wide
child

3487

19mm wide
Adolescent

3488

22mm wide
Adults



3489
180mm (7")

FLAT TONGUE DEPRESSOR

Double ended
tapering 19mm + 23mm



3490
140mm (5.1/2")



WEBSTER
Smooth Jaw

3491
115mm (4.1/2")



LAWRANCE

3492
150mm (6")
Lightweight

3493
150mm (6")



MAYO

3494
150mm (6")



MCPHAILS

3495
180mm (7")

NEEDLE HOLDERS



HALSEY

3496
125mm (5")



MATHIEU

3497
140mm (5.1/2")



MATHIEU

3498
170mm (6.3/4")



MATHIEU

3499
200mm (8")



MAYO (BAUMGARTNER)



3500
140mm (5.1/2")

MAYO (MASSON)



3501
265mm (10.1/2")

MAYO



3502
165mm (6.1/2")



3503
190mm (7.1/2")



3504
200mm (8")



3505
230mm (9")

HEGAR



3506
200mm (8")

NEEDLE HOLDERS

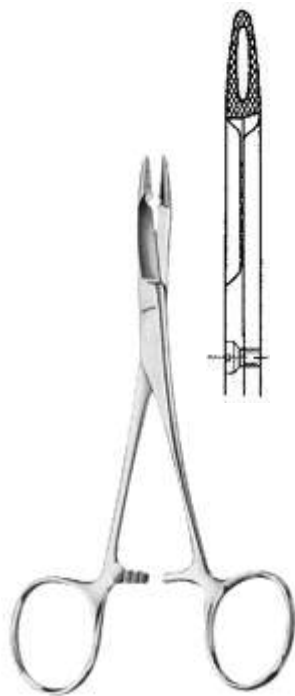

OLSEN HEGAR
Combined needle holder
and scissors

3507
140mm (5.1/2")

3508
165mm (6.1/2")

3509
190mm (7.1/2")



WARD
Combined needle holder
and scissors

3510
180mm (7")



JAMESON

3511
230mm (9")



WRIGHT

3512
125mm (5")



GILLIES

Combined needle holder
and scissors

3513
160mm (6.1/4")



KILNER

3514
135mm (5.1/4")



HEANEY

3515
200mm (8")

NEEDLE HOLDERS



CRILE WOOD

3516
150mm (6")



CRILE MURRAY

3517
145mm (5.3/4")



NAUNTON MORGAN

3518
190mm (7.1/2")

3519
250mm (10")



WANGENSTEEN

3520
270mm (10.3/4")



CONVERSE

3521
125mm (5")



DERF

3522
120mm (4.3/4")



MAYO (DUNHILL)

3523
160mm (6.1/4")



MAYO

3524
180mm (7")



MAYO

3525
190mm (7.1/2")



LITTLEWOOD

3526
185mm (7.1/4")
2 x 3 teeth



TUBING CLAMP

3527
175mm (7")

3528
200mm (8")



CASTROVIEJO

3529
145mm (5.3/4")
With catch



CASTROVIEJO

3530
145mm (5.3/4")
With catch



ARRUGA

3531
135mm (5.1/4")



BARRAQUER

3532
120mm (4.3/4")
With catch



BARRAQUER

3533
120mm (4.3/4")
Without catch

"TC" NEEDLE HOLDERS

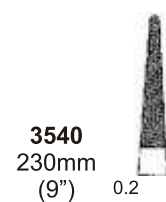
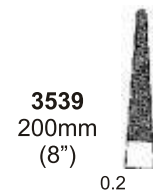
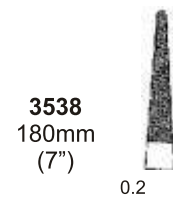
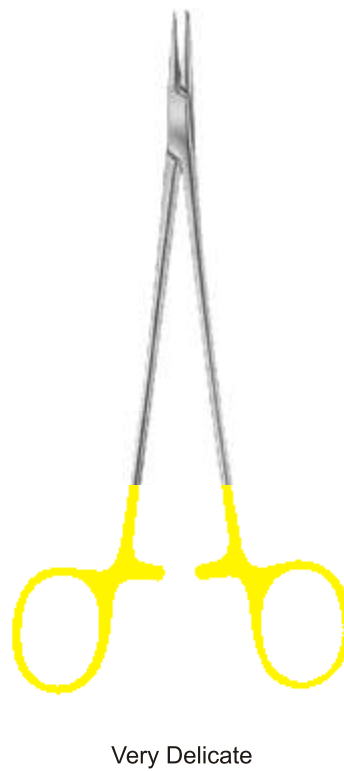
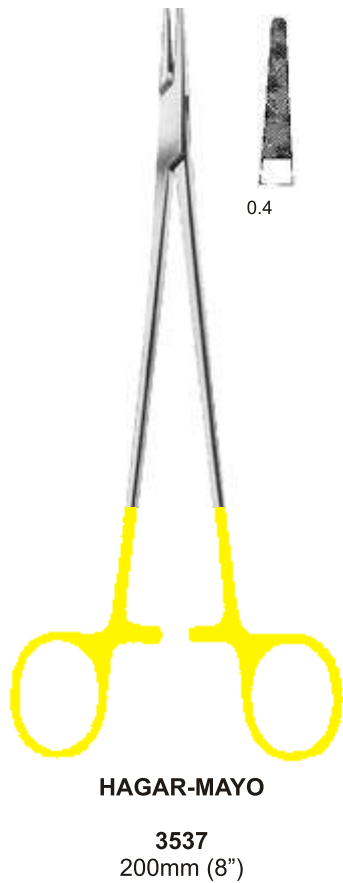
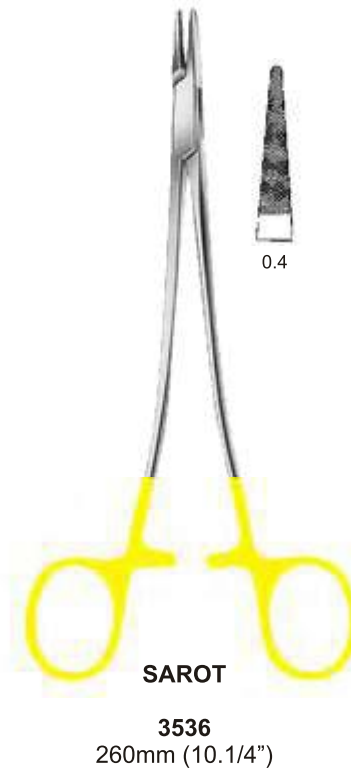
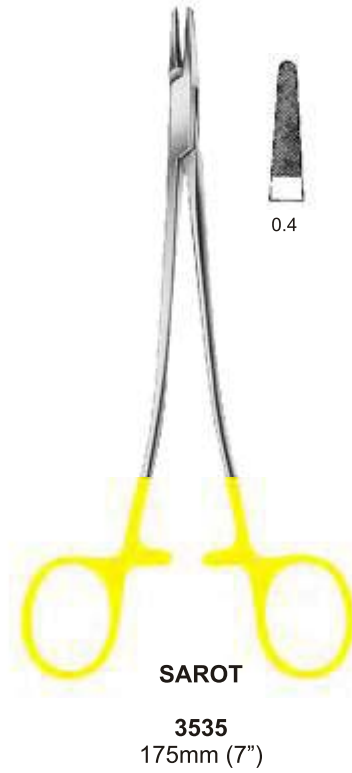
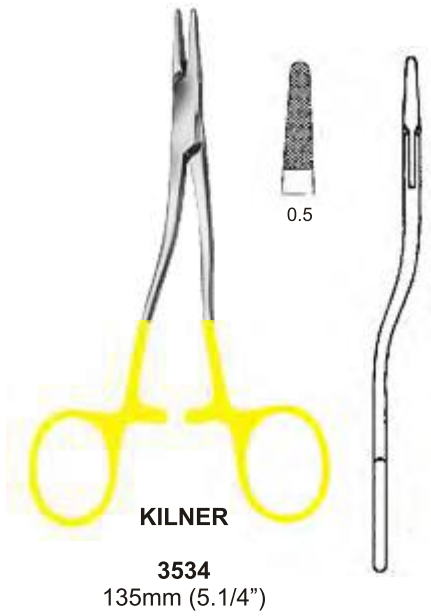

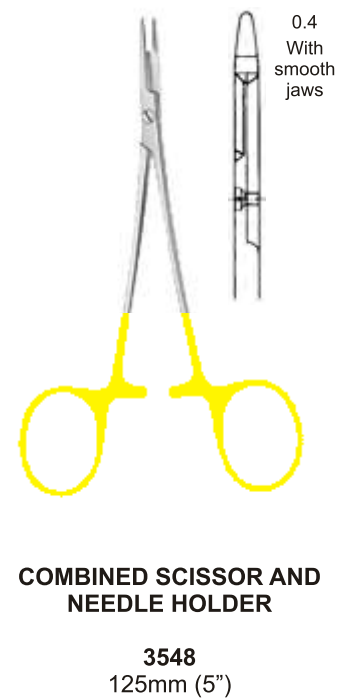
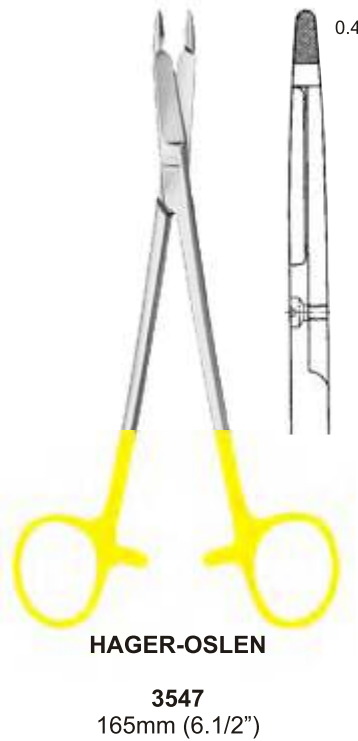
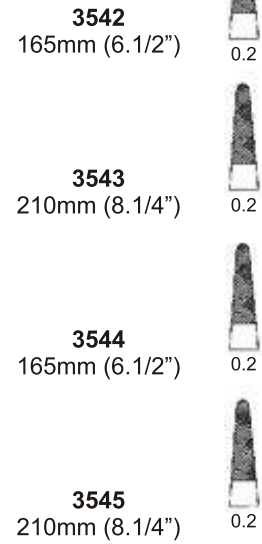
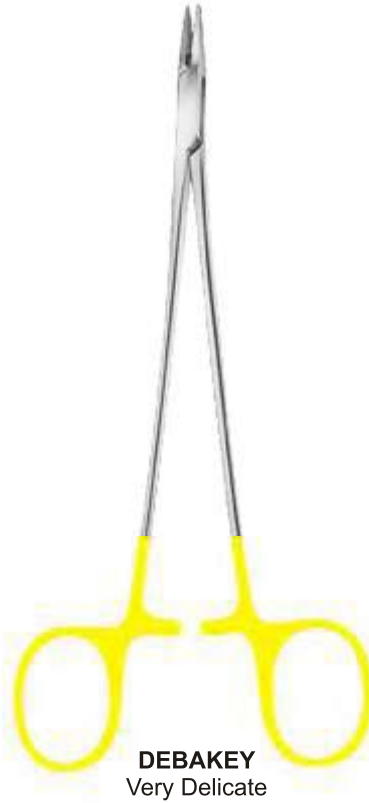
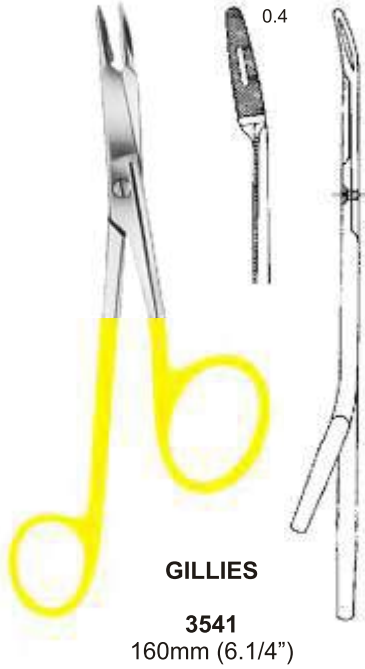

"TC" NEEDLE HOLDERS



3549
195mm (7.3/4")
Elastic pattern, delicate



3550
200mm (8")



HOESEL
3554
260mm (10.1/4")
With long neck



MATHIEU-STANDARD

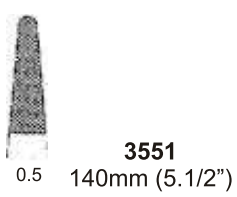

3551
140mm (5.1/2")

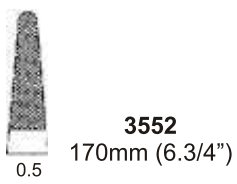

3552
170mm (6.3/4")

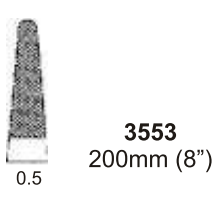

3553
200mm (8")



ZWEIFEL



0.5

3555
200mm (8")
Heavy pattern for
sternum suture



MATHIEU
Heavy pattern



0.5

3556
200mm (8")



0.5

3557
245mm (9.3/4")



0.4

3558
200mm (8")



0.4

3559
260mm (10.1/4")

With long neck



ZWEIFEL



0.5

3560
180mm (7")



0.5

3561
230mm (9")

"TC" NEEDLE HOLDERS



3562
200mm (8")

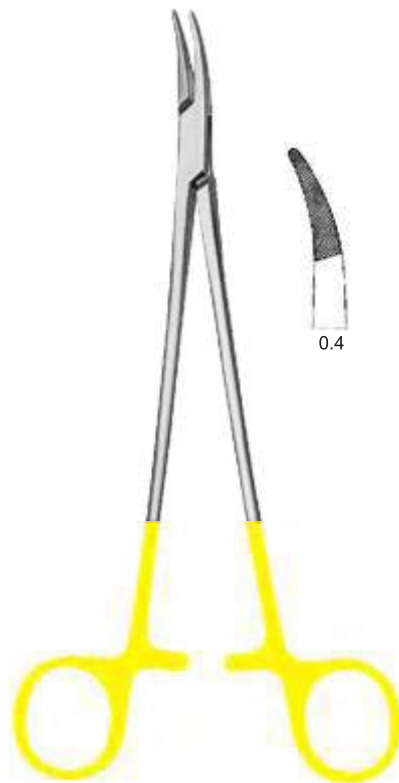

JULIAN
3563
200mm (8")



TOENNIS
3564
185mm (7.1/4")

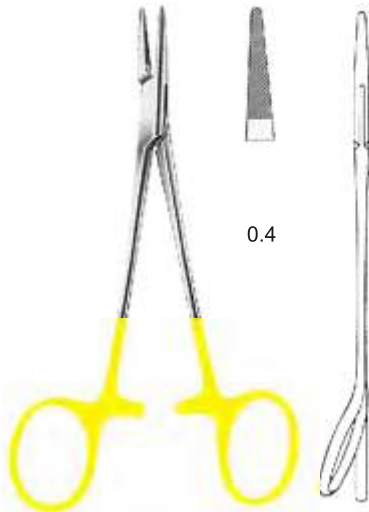

MASING

3565
130mm (5.1/8")
One ring angled

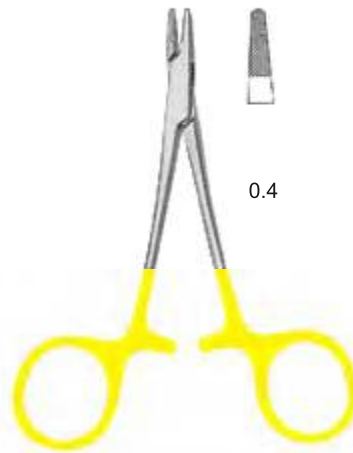

DERF

3566
115mm (4.1/2")

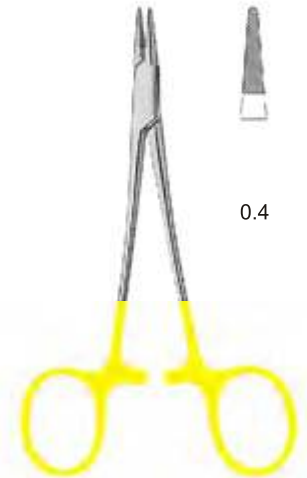

MASING

3567
125mm (5")



CRILE - WOOD



3568
180mm
(7")



3569
200mm
(8")



3570
305mm
(12.1/4")

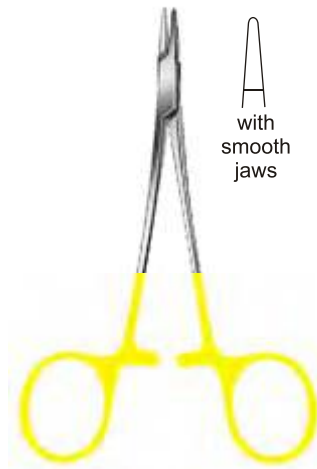

HALSEY

3571
120mm (4.3/4")

"TC" NEEDLE HOLDERS

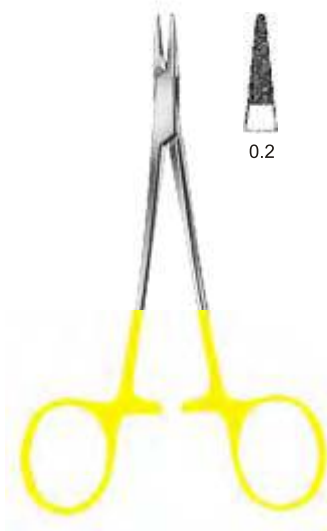

CONVERSE

3572
130mm (5.1/8")

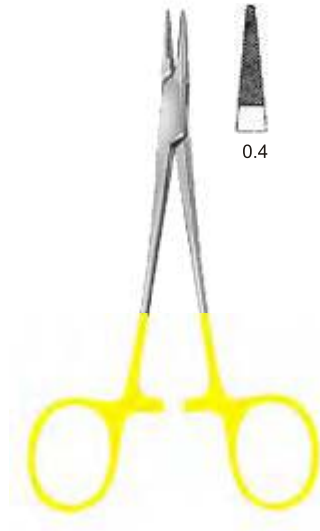

HALSEY

3573
130mm (5.1/8")



BABY-CRILE-WOOD

3574
150mm (6")

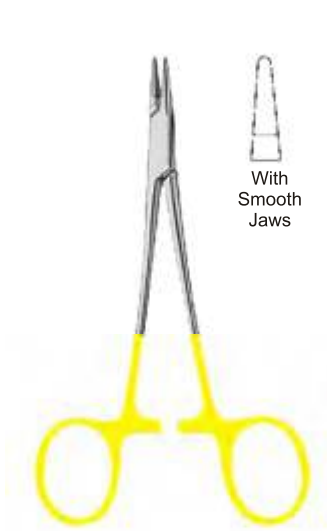

WEBSTER

3575
125mm (5")

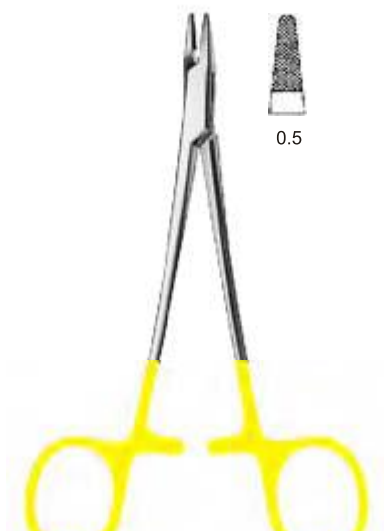

BAUMGARTNER

3576
145mm (5.3/4")

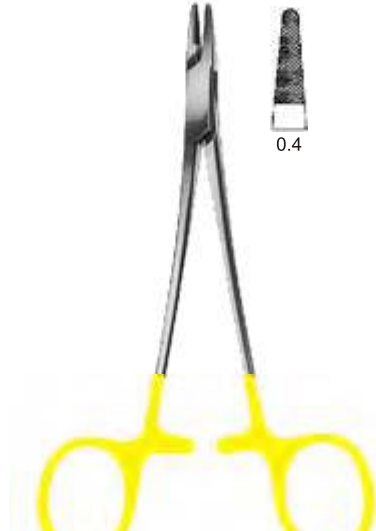

CRILE - WOOD

3577
145mm (5.3/4")

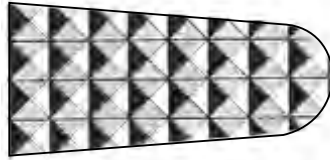

COARSE

For powerful needle holder patterns and wire twisters

Maximum holding capabilities for heavy needles or wire

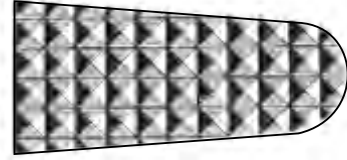

STANDARD

Used for example Mayo-Hegar, Mathieu Needle Holders

For needle 3-0 and larger

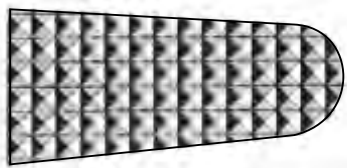

FINE

For delicate needle holders such as Crile Wood and Debakey

For needle and sutures between 4-0 and 6-0

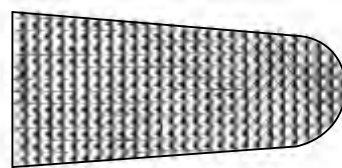

MICRO

For micro needle holder such as Castroviejo, Microvascular and Mini-Ryder

For delicate needle and sutures between 7-0 and 10.0



With Smooth Jaws

CASTROVIEJO

3578
145mm (5.3/4")



0.2

CASTROVIEJO

3579
145mm (5.3/4")



0.2

CASTROVIEJO

3580
180mm (7")



0.2

CASTROVIEJO

3581
215mm (8.1/2")

DISSECTORS



PAYR
3582
225mm (9")

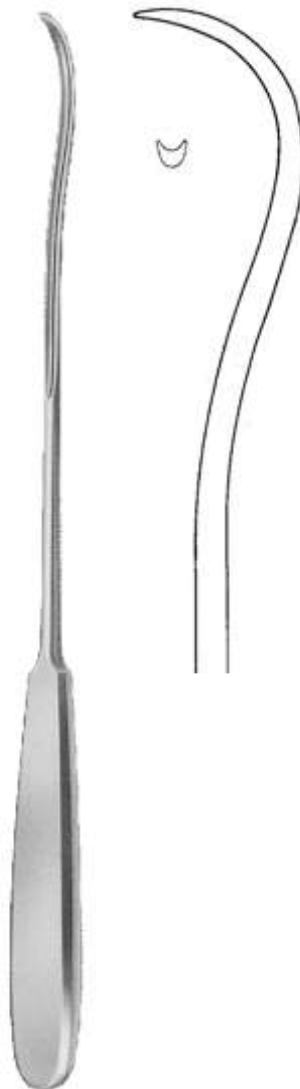

PAYR
3583
280mm (11")



GWYNNE EVANS TONSIL
200mm (8")
Double ended

3584
6mm wide

3585
8mm wide

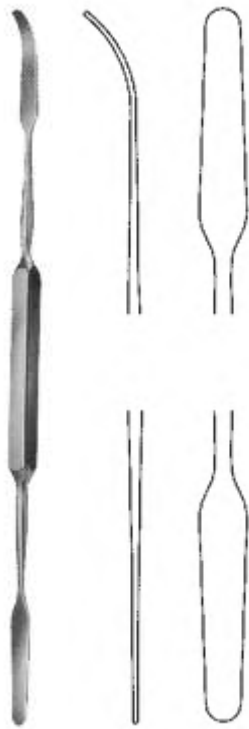

MACDONALD

3586
185mm (7.1/4")
Double ended



WATSON CHEYNE
Fine with probe

3587
125mm (5")

3588
190mm (7.1/2")

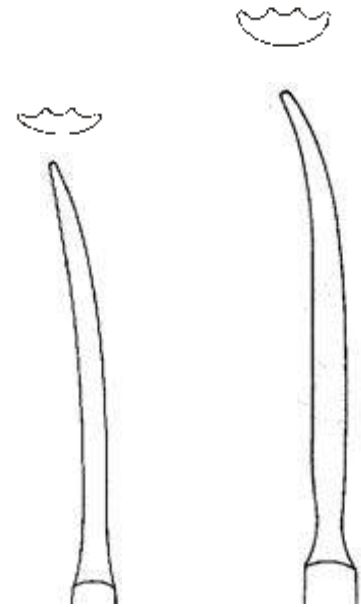

KOCHER THYROID

3589
150mm(6")

3590
170mm (6.3/4")





LIEBRICH LACHRYMAL

3591
No. 00 - 0 (0.7 - 0.8mm)

3592
No. 1 - 2 (0.9 - 1.1mm)

3593
No. 3 - 4 (1.3 - 1.4mm)

3594
No. 5 - 6 (1.5 - 1.6mm)



ANEL LACHRYMAL

3595
108mm (4.1/4") 0.6mm , small



CAWTHORNE

3596
140mm (5.1/2")



JOBSON HORNE

3597
140mm (5.1/2")

3598
178mm (7")



BRODIE

3599
200mm (8")
Ball point



DIRECTORS

3600
130mm (5.1/8")

3601
145mm (5.3/4")

3602
160mm (6.1/4")



3603
140mm (5.1/2")



NESTED TROCARS

3604
 171mm (6.3/4")
 1.9mm, 3.3mm,
 4.5mm and 6.0mm
 Set of four

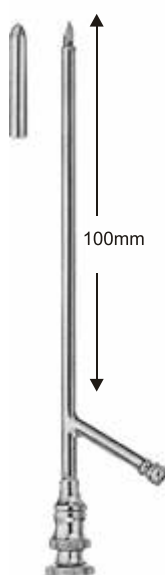

OSCHNER GALL BLADDER

- 3605**
I.D. 3.6mm O.D. 4.6mm
- 3606**
I.D. 5.0mm O.D. 6.0mm
- 3607**
I.D. 3.0mm O.D. 4.0mm
- 3608**
I.D. 4.3mm O.D. 5.3mm

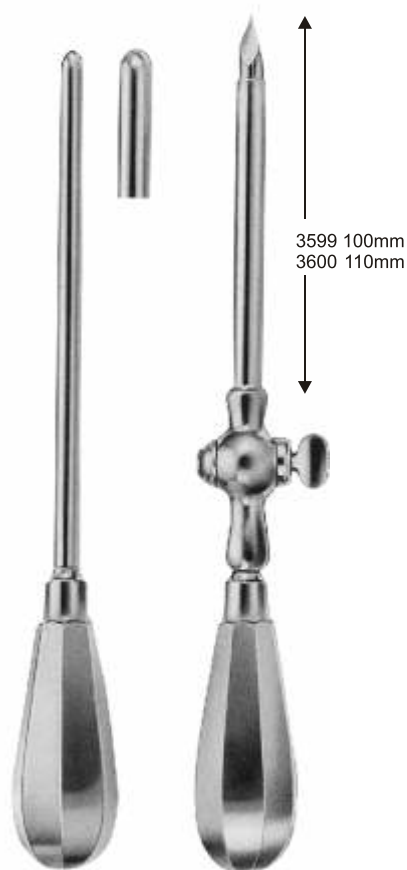

SUPRAPUBIC

- 3609**
I.D. 9.0mm O.D. 10.0mm
- 3610**
I.D. 7.0mm O.D. 8.0mm



**CHARNLEY INITIAL INCISION
RETRACTOR**
with weight and chain

3611

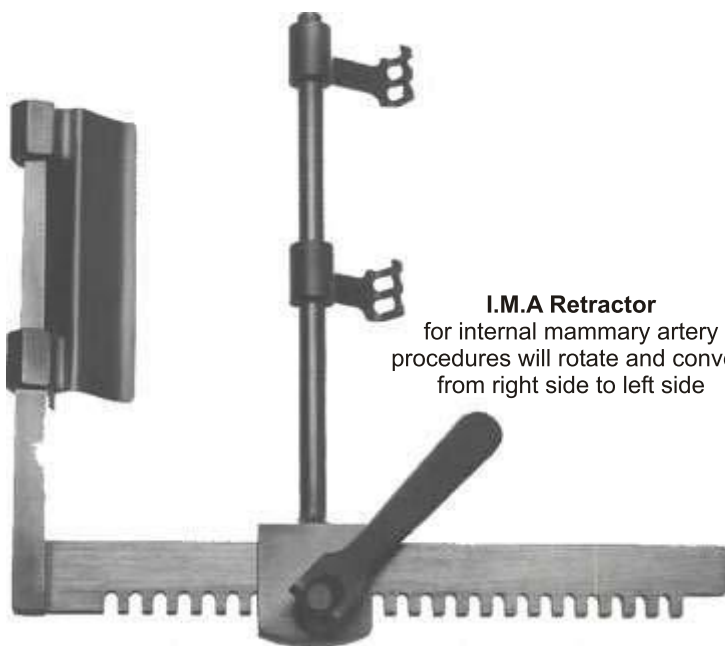

I.M.A Retractor
for internal mammary artery
procedures will rotate and convert
from right side to left side

I.M.A RETRACTOR

3612

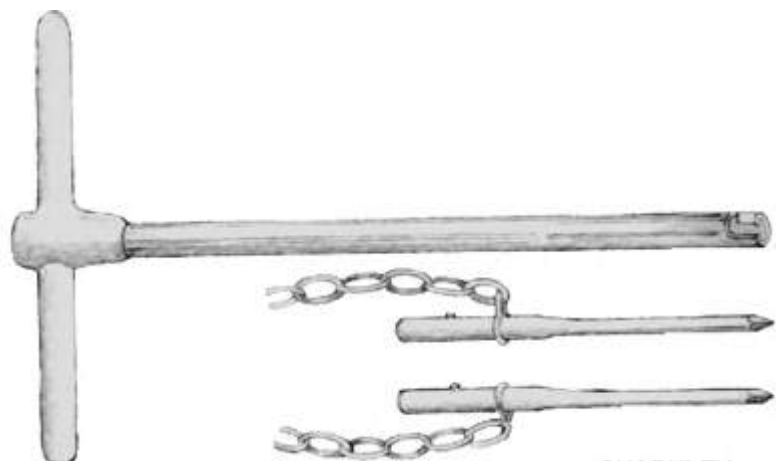

**CHARNLEY
PIN RETRACTOR**

3613

SELF RETAINING RETRACTORS

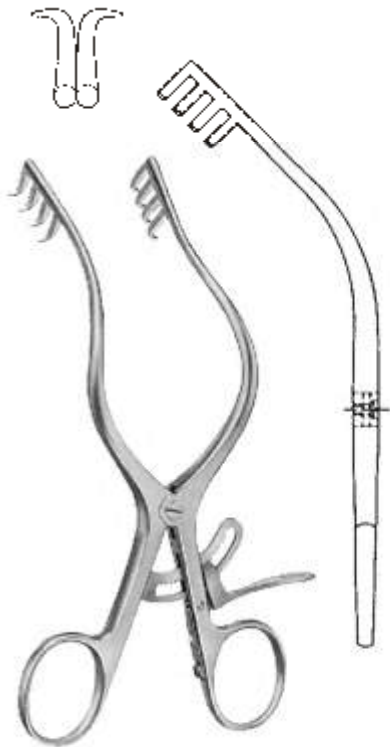

MOLLISON

3614
165mm (6.1/2")



MOLLISON

3615
133mm (5.1/4")



PLESTER-JANSEN

3616
140mm (5.1/2")



**PLESTER-JANSEN
Right
3617**
140mm (5.1/2")

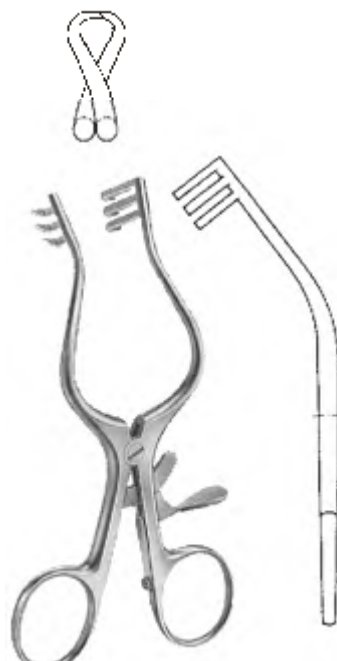

PLESTER-JANSEN
3618
140mm (5.1/2")

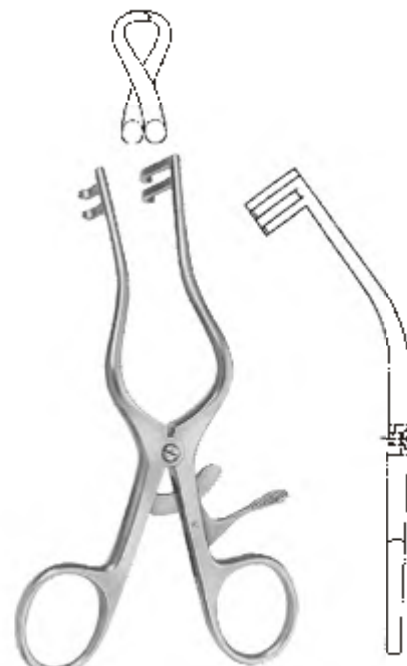

**WALACE MODIFIED
PLESTER-JANSEN**
3619
140mm (5.1/2")

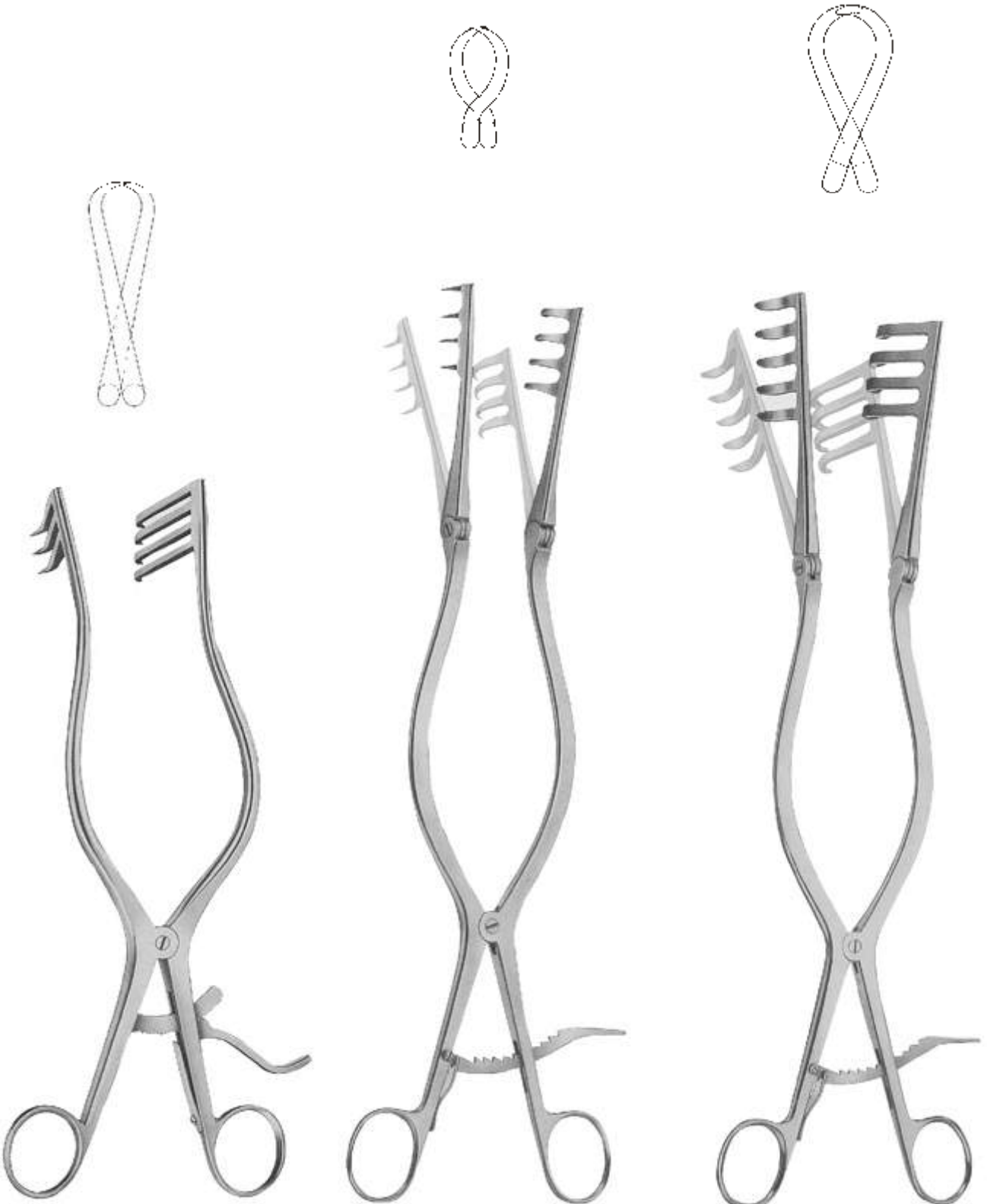

ADSON

3620
265mm (10.1/2")

BECKMANN-ADSON

3621
310mm (12")

ADSON

3622
320mm (12.3/4")
Semi - sharp

SELF RETAINING RETRACTORS



CONE

3623
145mm (5.3/4")



JANSON (SHEA)

3624
105mm (4.1/8")

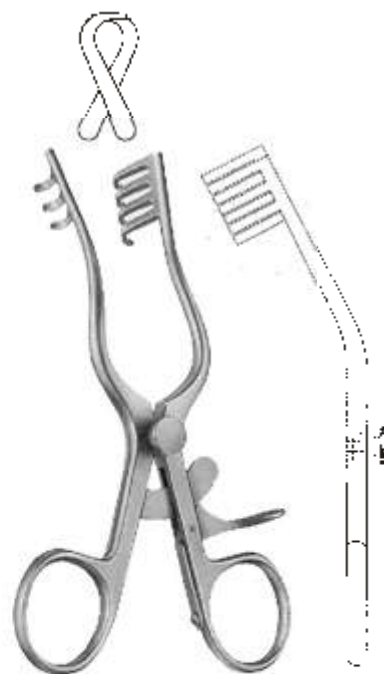

JEFFERSON

3625
140mm (5.1/2")



HENDERSON

3626
130mm (5.1/8")



TRAVERS

3627
195mm (7.3/4")
Sharp



TURNER WARWICK

3628
140mm x 180mm (7" x 5.1/2")
Oval sprocket frame and four blades



GELPI VULVA

3629
165mm (6.1/2")



GELPI VULVA

3630
135mm (5.1/4")



JACKSON - BURROWS

3631
165mm (6.1/2")



FINSON

3632
70mm (2.3/4")

SELF RETAINING RETRACTORS

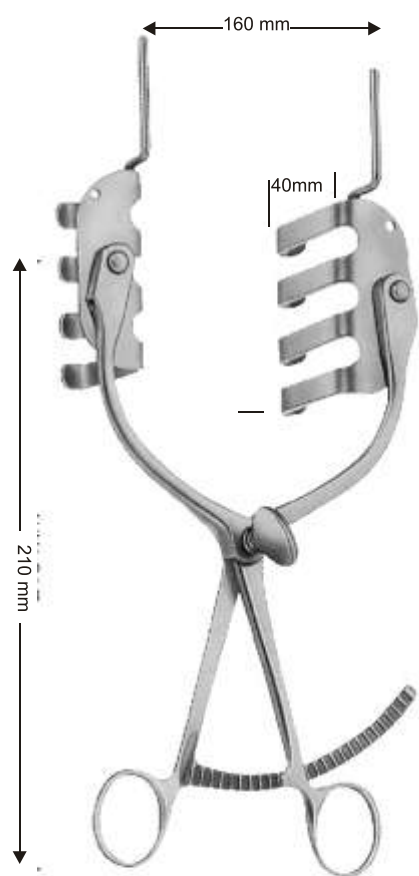

**ST MARKS HOSPITAL
PERINEAL**
210mm (8.3/8")

3633
Blades: 70mm x 40mm



JOLL THYROID

3634
152mm (6")



MILLIN RETROPUBIC

3635
Blades
55mm x 25mm
80mm x 25mm

Centre blade:
115mm x 45mm



WEISLANDER

3636
110mm (4.3/8")
2 x 3teeth, sharp



WEISLANDER

3637
110mm (4.3/8")
2 x 3 teeth. blunt



RNTNE HOSPITAL

3638
159mm (6.1/4")
3 x 4 teeth



NORFOLK AND NORWICH

3639
215mm (8.1/2")
4 x 5 teeth, blunt

SELF RETAINING RETRACTORS



GOLIGHER

3640

Complete with two centre blades: 51mm deep, and four lateral blades:
2 x 51mm deep
2 x 102mm deep

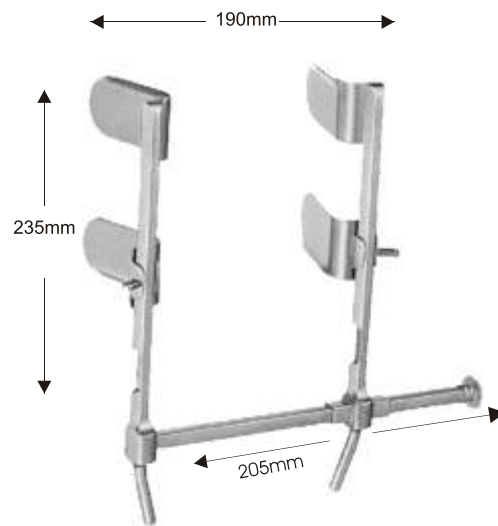

BERKELEY ABDOMINAL

3641

Blades: 35mm x 60mm



TRAVERS

3642

200mm (8")
4 x 5 teeth
Blunt



IRWIN

3643

178mm (7")
4 x 5 teeth
Sharp

KIRSCHNER RETRACTOR SET

3644
Set comprising of:
1 x L40-08008
2 x L40-08009
2 x L40-08010

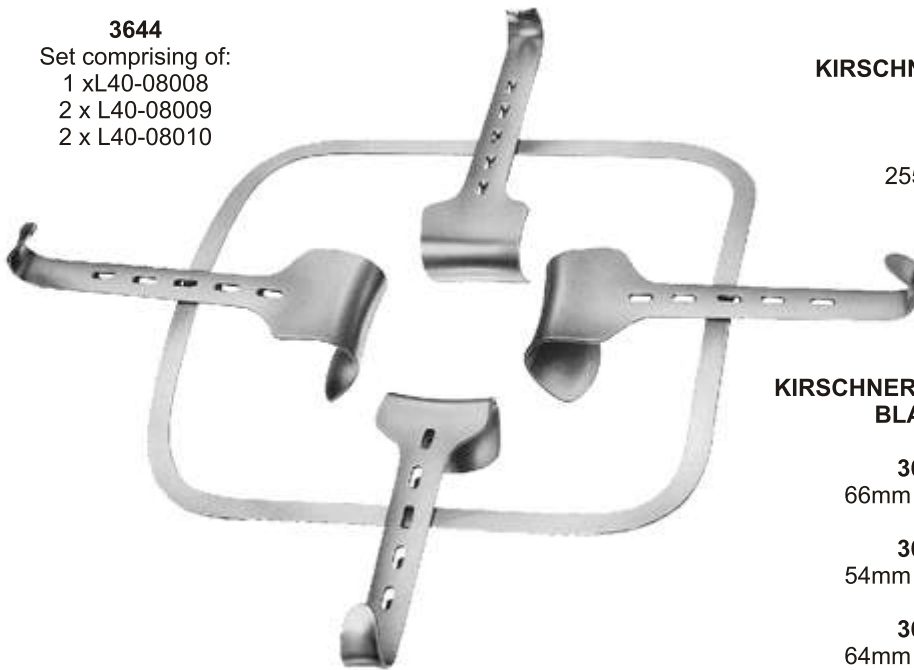

KIRSCHNER RETRACTOR FRAME

3645
255mm square

KIRSCHNER RETRACTOR BLADES

3646
66mm x 48mm

3647
54mm x 42mm

3648
64mm x 80mm

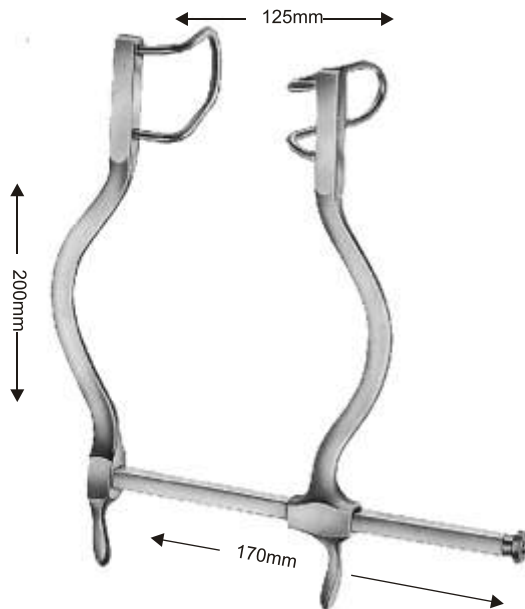

GOSSET

3649
Blades: 55mm

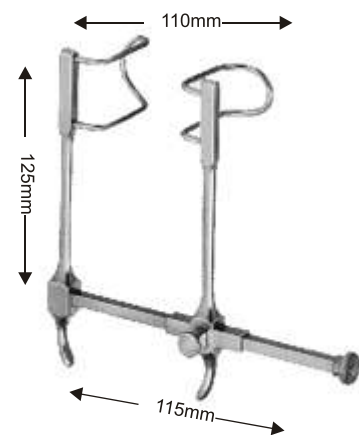

GOSSET

3650
Blades: 38mm

SELF RETAINING RETRACTORS

TURNER WARWICK RETRACTOR BLADES



3651

Blade: 51mm x 38mm
Curved, blackened finish

3652

Blade: 76mm x 60mm
Curved, blackened finish



3653

Blade: 89mm x 60mm
Flat, polished front surface

3654

Blade: 114mm x 60mm
Flat polished front surface



3655

13mm deep
Single hook blade

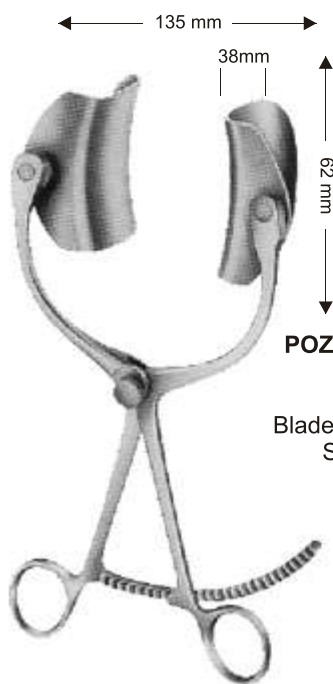

POZZI ABDOMINAL

3656

Blades: 62mm x 38mm
Swivel blades



POZZI ABDOMINAL

3657

Lateral blades:
62mm x 38mm

Center blade:
55mm x 55mm

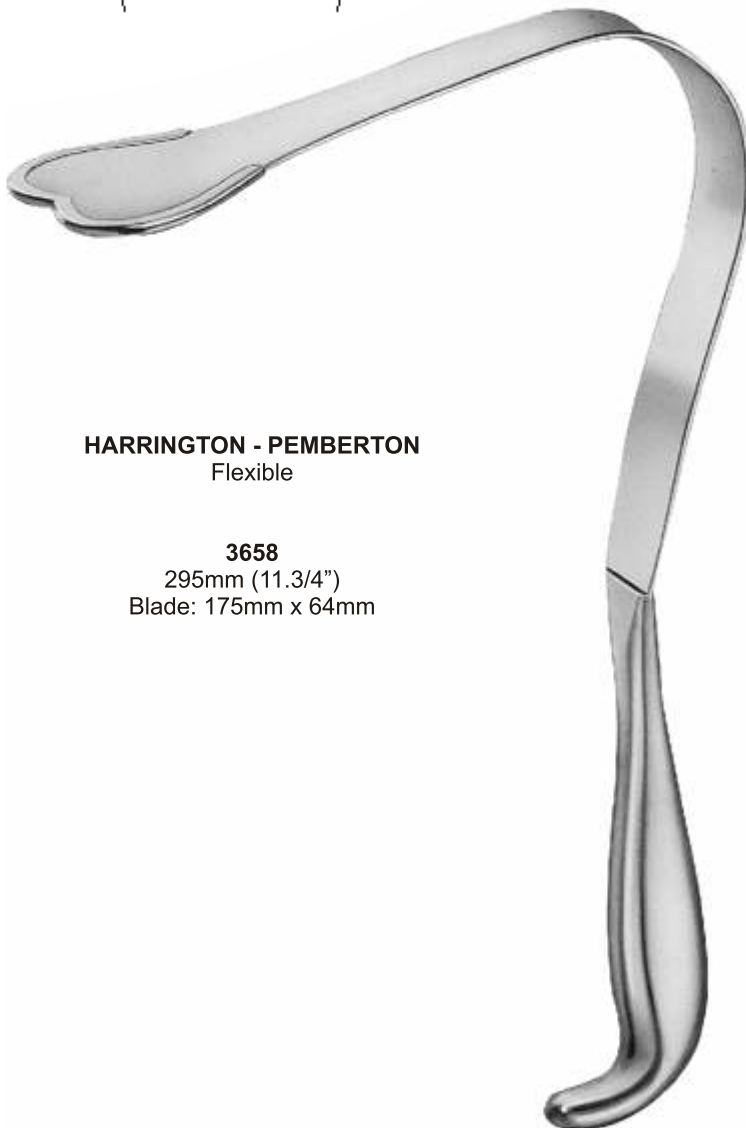
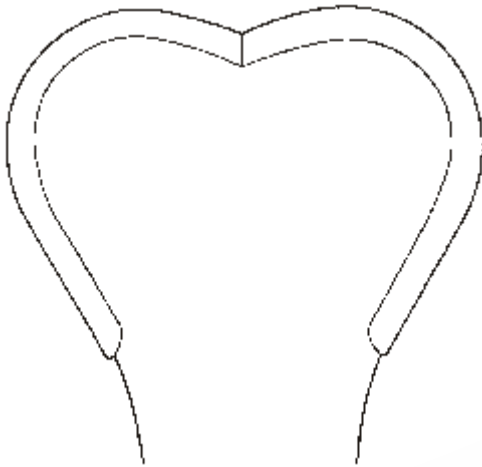

HARRINGTON - PEMBERTON
Flexible

3658
295mm (11.3/4")
Blade: 175mm x 64mm



ALLISON

3659
255mm (10")
Blade: 40mm wide

RETRACTOR



RETRACTOR
155mm (6")
Flexible shaft



3660
2 prong, sharp



3663
2 prong, blunt



3661
3 prong, sharp



3664
3 prong, blunt



3662
4 prong, sharp



3665
4 prong, blunt



3666
125mm (5")



3667
135mm (5.1/4")



3668
130mm (5.1/8")



RETRACTOR



KILNER
150mm (6")

3669
Sharp

3670
Blunt



**LANGENBECK
BONE HOOK**

3671
205mm (8")
Sharp



**LANGENBECK
BONE HOOK**

3672
205mm (8")
Blunt



**KOCHER
BONE HOOK**

3673
220mm (8.3/4")
Sharp



**KOCHER
BONE HOOK**

3674
220mm (8.3/4")
Blunt

HAND HELD RETRACTORS



WERTHEIM

3675
300mm (12")
Blade: 100mm x 40mm

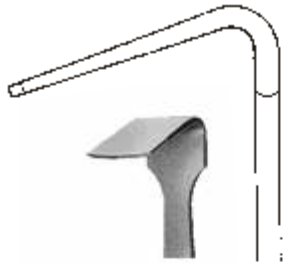

3676
Blade: 32mm x 19mm



3677
Blade: 41mm x 19mm

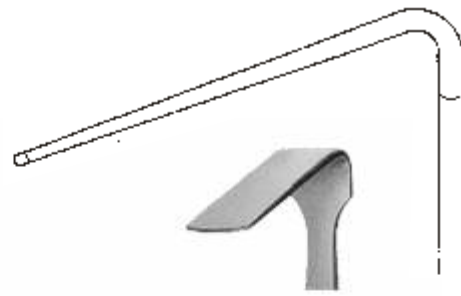

3678
Blade: 57mm x 19mm



SMILLIE RETRACTORS

3679
145mm (5.3/4")

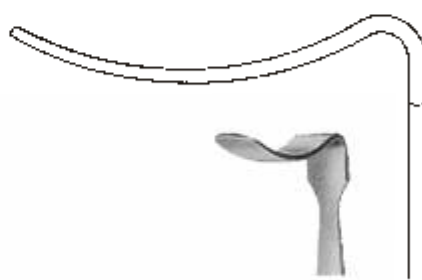

3680
Blade: 10mm



3681



ABDOMINAL RETRACTOR
240mm (9.1/2")

3682

Blade: 34mm x 50mm

3683

Blade: 46mm x 75mm

3684

Blade: 64mm x 85mm

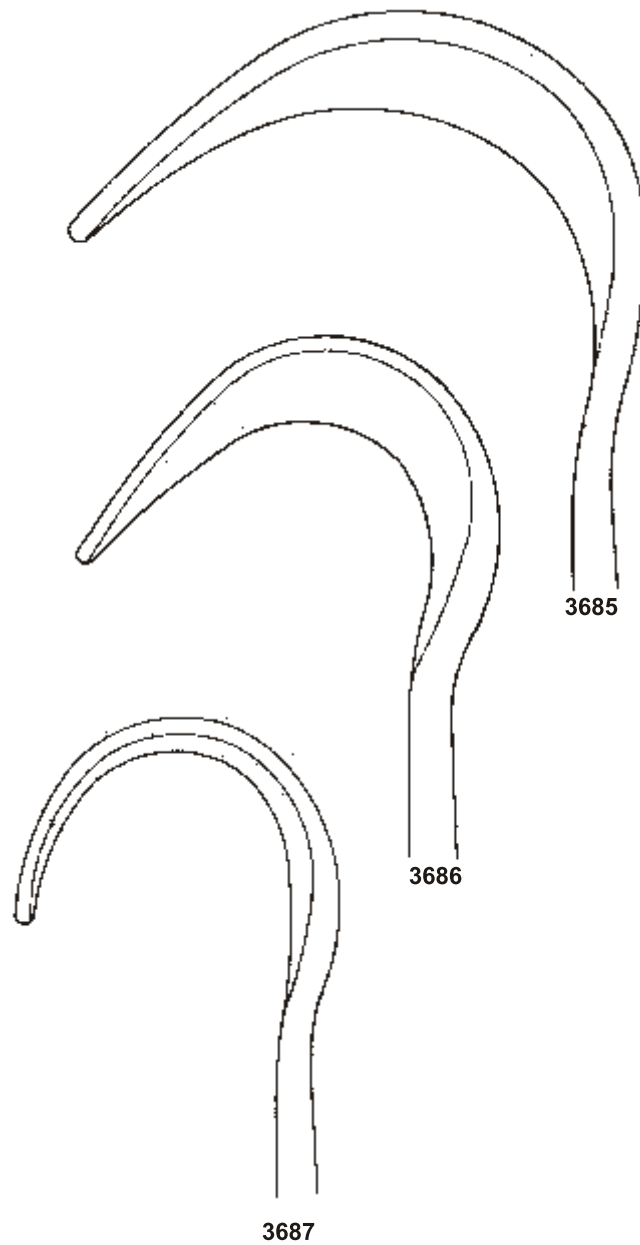

HAND HELD RETRACTORS



ISRAEL
255mm (10")1



3688
Blade: 39mm x 40mm
Blunt



3689
Blade: 47mm x 51mm
Blunt



3690
Blade: 53mm x 62mm
Blunt

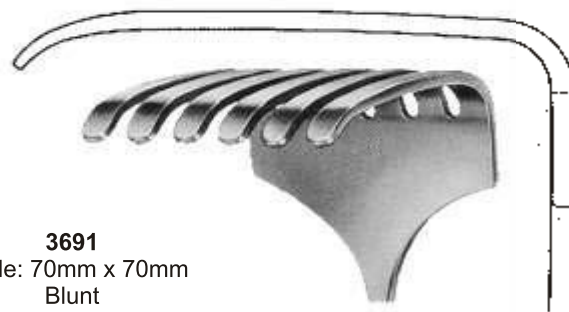

3691
Blade: 70mm x 70mm
Blunt



3697



3698



LEMPERT
225mm (9")

3692
Blade 9mm x 19mm
Sharp

3693
Blade 8.5mm x 19mm
Blunt



BALLANCE
225mm (9")

3694
Blade 9mm x 29mm
Sharp

3695
Blade 8.5mm x 29mm
Blunt



36mm

38 x 42mm

CZERNY

3696
175mm (7")

HAND HELD RETRACTORS



3699



3701



3703



3705



3700



3702



3704



3706

165mm (6.1/2")
Small curve sharp

165mm (6.1/2")
Small curve blunt



3707



3709



3711



3713



3708



3710



3712



3714

165mm (6.1/2")
Large curve sharp

165mm (6.1/2")
Large curve blunt



RICHARDSON
240mm (9.1/2")

3715
Blade: 23mm x 20mm



3716
Blade: 30mm x 29mm

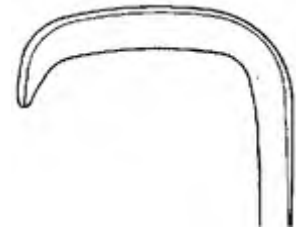

3717
Blade: 37mm x 37mm



3718
Blade: 47mm x 21mm

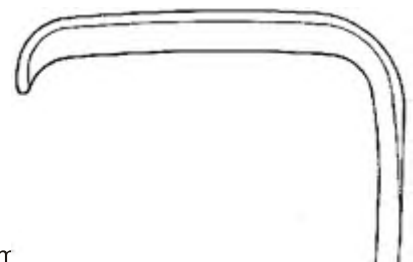

HAND HELD RETRACTORS



MIDDELDORPF



3719
220mm (8.3/4")
Blade: 15mm x 15mm



3720
215mm (8.1/2")
Blade: 20mm x 22mm



3721
235mm (9.1/4")
Blade: 28mm x 28mm

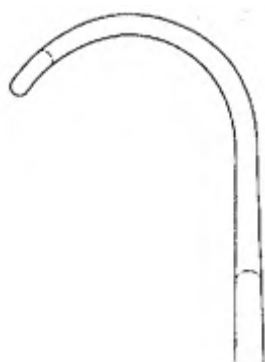

DURHAM
215mm (8.1/2")

3722
Blade: 10mm

3723
Blade: 16mm

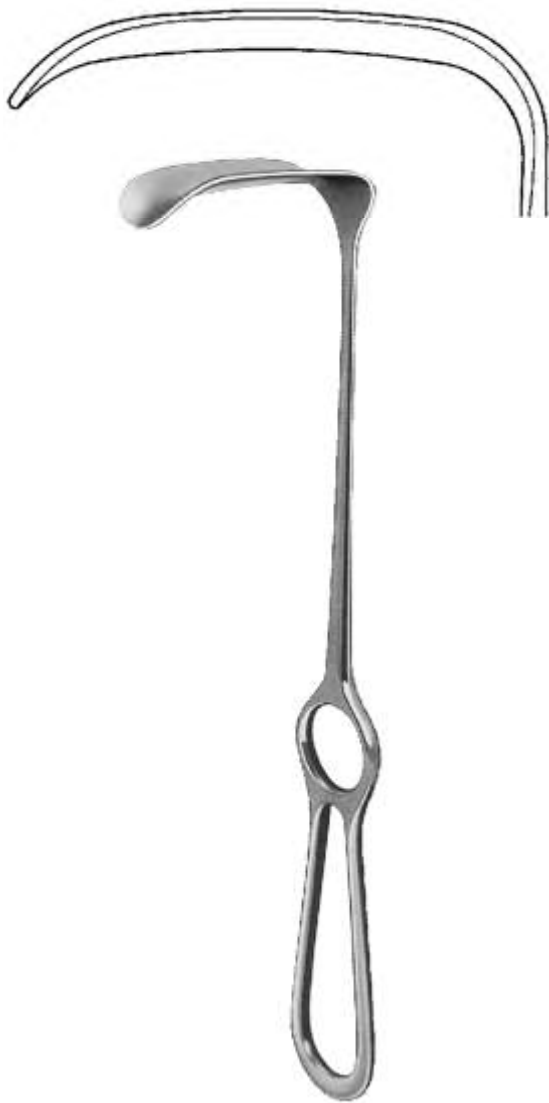

KOCHER
3724
250mm (10")
Blade: 67mm x 25mm



CUSHINGS VEIN RETRACTORS
250mm (10")



3725
Blade: 14mm x 11mm



3726
Blade: 18mm x 13mm



3727
Blade: 22mm x 15mm

HAND HELD RETRACTORS

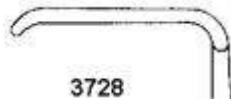

3728
Blade: 25mm x 6mm

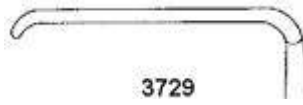

3729
Blade: 35mm x 8mm

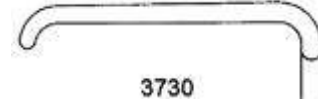

3730
Blade: 35mm x 11mm

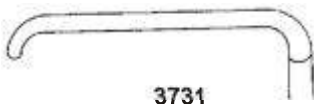

3731
Blade: 35mm x 15mm

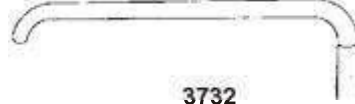

3732
Blade: 41mm x 11mm

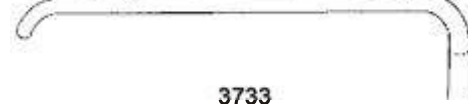

3733
Blade: 55mm x 11mm



LANGENBECK
215mm (8.1/2")

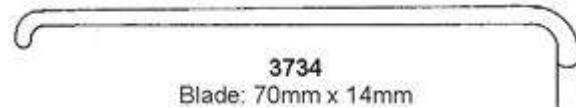

3734
Blade: 70mm x 14mm

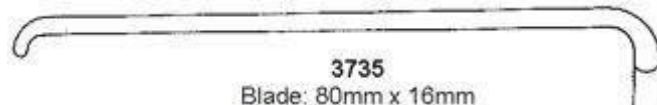

3735
Blade: 80mm x 16mm



KOCHER
230mm (9")

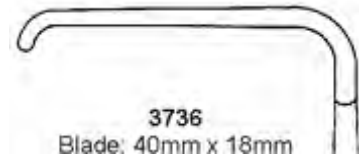

3736
Blade: 40mm x 18mm

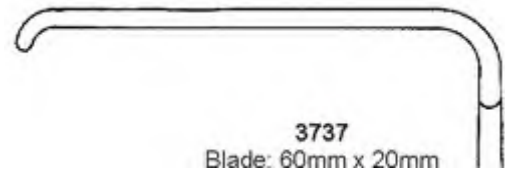

3737
Blade: 60mm x 20mm

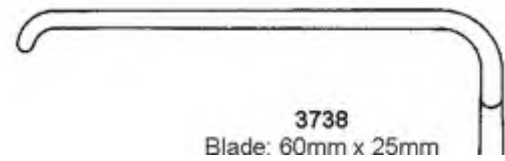

3738
Blade: 60mm x 25mm

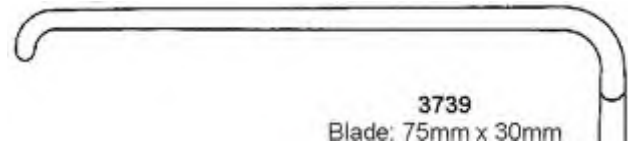

3739
Blade: 75mm x 30mm

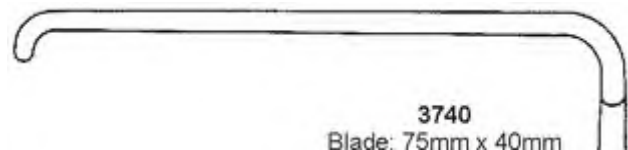

3740
Blade: 75mm x 40mm

HAND HELD RETRACTORS



DEAVER

3741
300mm (12")
Blade: 38mm wide

DEAVER

3742
310mm (12.1/4")
Blade: 50mm wide

DEAVER

3743
320mm (12.3/4")
Blade: 75mm wide



DEAVER GRIP

No 1
3744
310mm (12.1/4")
Blade: 25mm wide



DEAVER GRIP

No 2
3745
310mm (12.1/4")
Blade: 38mm wide

HAND HELD RETRACTORS



DEAVER GRIP

No 3
3746
302mm (12")
Blade: 50mm wide



DEAVER GRIP

No 4
3747
310mm (12.1/4")
Blade: 75mm wide



DEAVER

3748
300mm (12")
Blade: 25mm wide



DEAVER

3749
315mm (12.1/2")
Blade: 25mm wide

INTESTINAL CLAMPS



LANE TWIN ANASTOMOSIS

3750
300mm (12") Curved



LANE TWIN ANASTOMOSIS

3751
300mm (12") Straight



LLOYD DAVIS RECTAL OCCLUSION

3752
315mm (12.1/2")
Angleg



RESANO

3753
265mm (10.1/2")
Colon resection clamp

INTESTINAL CLAMPS



DOYEN
165mm (6.1/2")
Spring blades



3754
Straight



3755
Curved



3758
Straight



3759
Curved

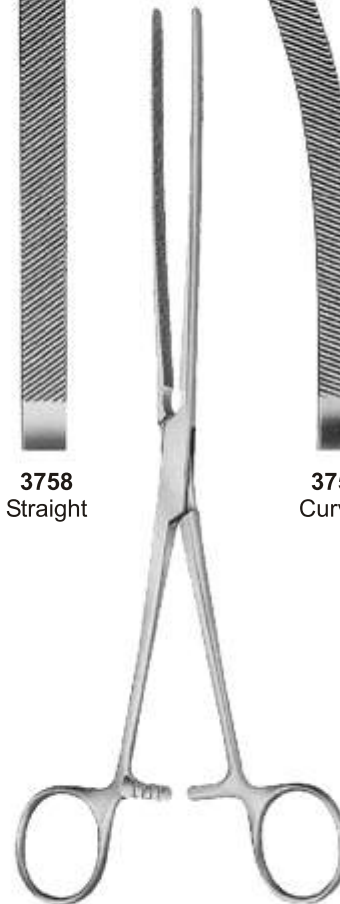

DOYEN
235mm (9.3/4")
Spring blades



DOYEN
170mm (6.3/4")
Spring blades

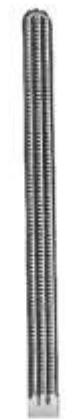

3756
Straight



3757
Curved



DOYEN
230mm (9")
Spring blades

3760
Straight

3761
Curved



DOYEN (KOCHER)
Straight, light spring blade

3762
230mm (9")

3763
250mm (10")

3764
280mm (11")

3765
210mm (8.1/4")



DOYEN (MAYO ROBSON)
Curved, light spring blade

3766
230mm (9")

3767
250mm (10")

3768
280mm (11")

3769
210mm (8.1/4")

CHOLECYSTECTOMY AND GALL STONE FORCEPS



BLAKE
3770
205mm (8")
Straight



BLAKE
3771
205mm (8")
Curved



**DUCT DISSECTING / DILATING
FORCEPS**
3772
260mm (10.1/4")



MOYNIHAN
3773
345mm (13.3/4")
Gall stone probe and scoop
malleable



OCHSNER
3774
400mm (16")
Gall duct probe flexible



DESJARDINS
285mm (11.1/4")
Gall duct probes, flexible



MIXSTER

3778
220mm (8.3/4")

3779
250mm (10")



MOYNIHAN

3780
230mm (9")

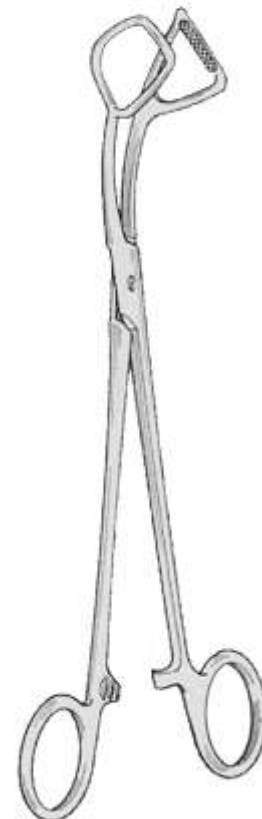

**MOUAT GALL BLADDER
LIFTING FORCEPS**

3781
215mm (8.1/2")

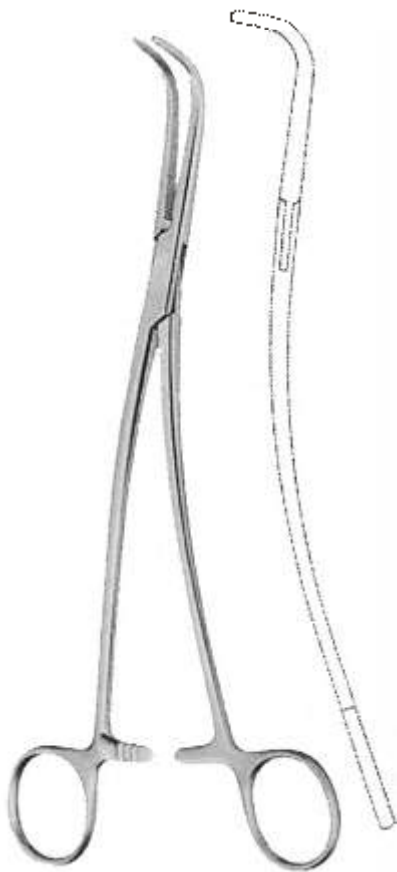

GEARY GRANT

3782
230mm (9")
Large curved



LAHEY

3783
195mm (7.3/4")

3784
230mm (9")



LOWER

3785
180mm (7")



MODIFIED DOYEN

3786
250mm (10")
Blade: 80mm x 30mm
Lateral Speculum

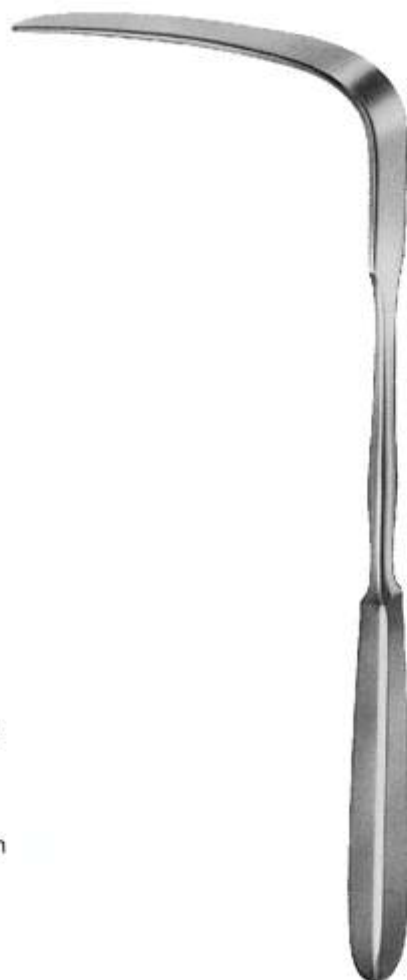

SIMON
275mm (10.3/4")

3787
Blade: 115mm X 26mm

3788
Blade: 115mm x 22mm

3789



AUVARD

3790
230mm (9")
Blade: 63mm x 38-28mm
Weight: 1.53 Kg (3lb, 60z)
Fixed weight

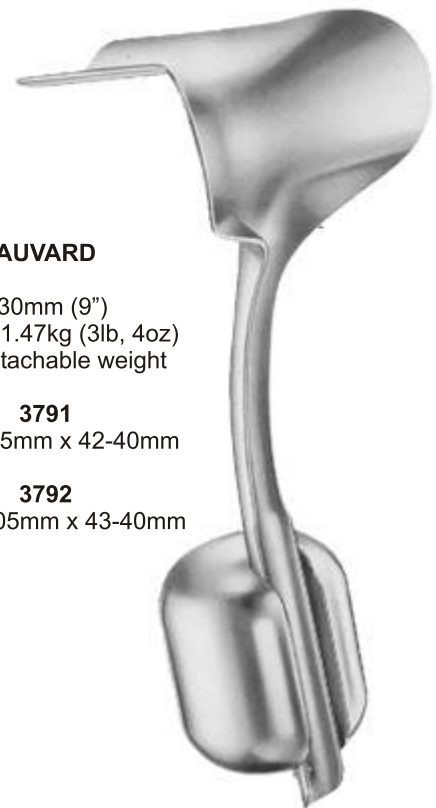

AUVARD

230mm (9")
Weight: 1.47kg (3lb, 4oz)
with detachable weight

3791
Blade: 75mm x 42-40mm

3792
Blade: 105mm x 43-40mm



3793

3794	6mm
3795	7mm
3796	8mm
3797	9mm
3798	10mm
3799	11mm
3800	12mm
3801	13mm
3802	14mm
3803	15mm
3804	16mm
3805	17mm

HAWKIN AMBLER
170mm (6.3/4")
Cervix dilator



3806

Set of sixteen
consisting of one of
each of: 3791 to 3806

3807	2mm	3818	13mm	3829	8.5mm
3808	3mm	3819	14mm	3830	9.5mm
3809	4mm	3820	15mm	3831	10.5mm
3810	5mm	3821	16mm	3832	11.5mm
3811	6mm	3822	17mm	3833	12.5mm
3812	7mm	3823	2.5mm	3834	13.5mm
3813	8mm	3824	3.5mm	3835	14.5mm
3814	9mm	3825	4.5mm	3836	15.5mm
3815	10mm	3826	5.5mm	3837	16.5mm
3816	11mm	3827	6.5mm	3838	17.5mm
3817	12mm	3828	7.5mm		

HEGAR
185mm (7.1/4")
Cervix dilator

VAGINAL SPECULUM



Lower blade

3839
175mm (7")
Blade:
70mm x 15mm



3840
180mm (7")
Blade:
70mm x 27mm



3841
180mm (7")
Blade:
75mm x 30mm

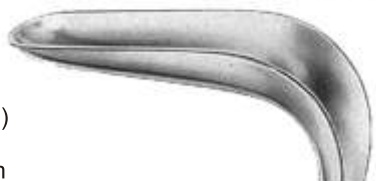

3842
185mm (7.1/4")
Blade:
90mm x 36mm

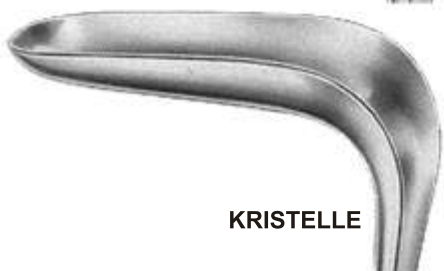

KRISTELLE



Upper blade

3843
175mm (7")
Blade:
70mm x 10mm



3844
180mm (7")
Blade:
75mm x 23mm



3845
180mm (7")
Blade:
80mm x 25mm



3846
185mm (7.1/4")
Blade:
100mm x 32mm



KRISTELLE



**KOGAN ENDOCERVICAL
SPECULUM**

3847
240mm (9.1/2")
Graduated



MODIFIED WERTHEIM
320mm (12.3/4")

3848
Blade: 100mm x 25mm

3849
Blade: 100mm x 30mm

3850
Blade: 100mm x 35mm

3851
Blade: 100mm x 40mm

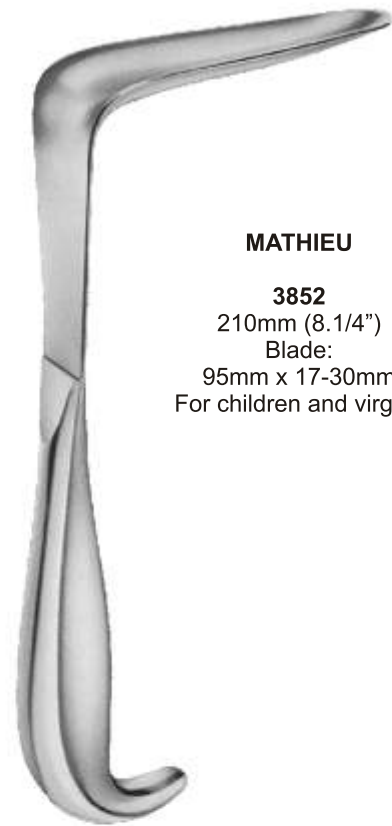

MATHIEU

3852
210mm (8.1/4")
Blade:
95mm x 17-30mm
For children and virgins

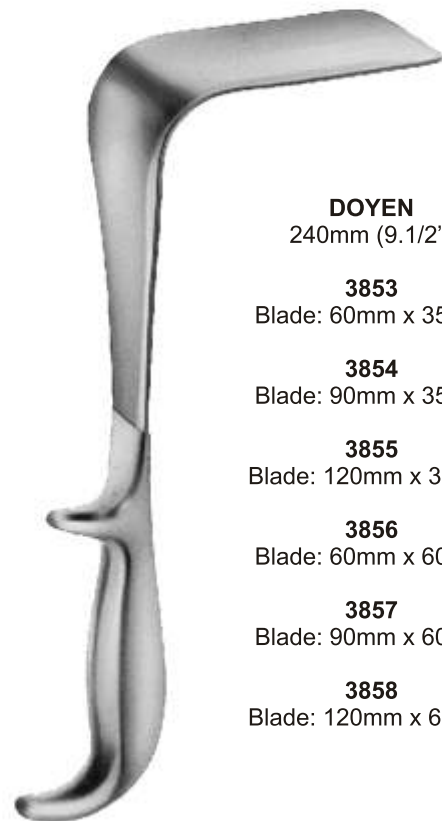

DOYEN
240mm (9.1/2")

3853
Blade: 60mm x 35mm

3854
Blade: 90mm x 35mm

3855
Blade: 120mm x 35mm

3856
Blade: 60mm x 60mm

3857
Blade: 90mm x 60mm

3858
Blade: 120mm x 60mm

VAGINAL SPECULUM



CUSO
3859
75mm x 17mm
Extra small for virgins

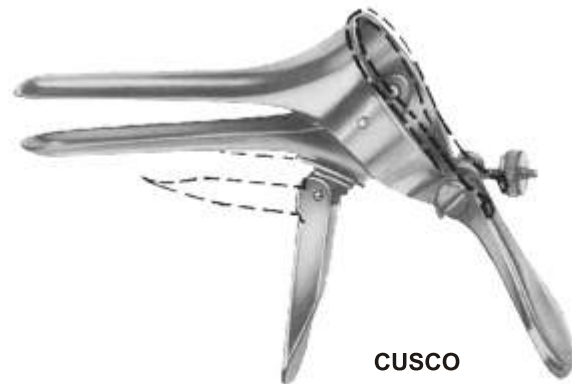

CUSO
3860
75mm x 17mm
Extra small for virgins



**McGEE LATERAL
VIGINAL RETRACTOR**
with ratch handle
3861



CUSO
3862 110mm x 37mm
3863 80mm x 32mm
3864 80mm x 24mm

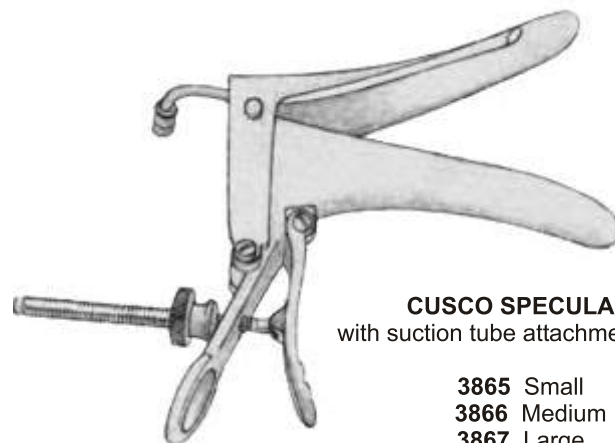

CUSO SPECULAM
with suction tube attachment black

3865 Small
3866 Medium
3867 Large



GRAVE

- 3868** 75mm x 20mm
- 3869** 95mm x 30mm
- 3870** 195mm x 33mm



PEDERSON

- 3871** 100mm x 22 mm
- 3872** 120mm x 25mm



SIMS

- 3873**
125mm (5")
Small
70mm x 26mm
75mm x 30mm
- 3874**
150mm (6")
Medium
75mm x 30mm
80mm x 35mm
- 3875**
175mm (7")
Large
80mm x 36mm
90mm x 40mm

CLUTTON URETHRAL SOUNDS

265mm (10.1/2")

Set twelve **3876**

Set Comprising one of each of:

3877	6/10 f.g (2/3.33mm)
3878	8/12 f.g (2.66/4.66mm)
3879	10/14 f.g (3.33/4.66mm)
3880	12/16 f.g (4/5.33mm)
3881	14/18 f.g (4.66/6mm)
3882	16/20 f.g (5.33/6.66mm)
3883	18/22 f.g (6/7.33mm)
3884	20/24 f.g (6.66/8mm)
3885	22/26 f.g (7.33/8.66mm)
3886	24/28 f.g (8/9.33mm)
3887	26/30 f.g (8.66/10.66mm)
3888	
3889	
3890	
3891	



3892

12 f.g (4mm)

3893

8 f.g (2.66mm)

3894

10 f.g (3.33mm)

3895

14 f.g. (4.66mm)

3896

16 f.g. (5.33mm)



FEMALE CATHETERS

160mm (6.1/4")



**TURNER WARWICK (HEY GROVES)
URETHRAL STAFF**

3897
Black finish 180mm (7")



**TURNER WARWICK
DISSECTING SCISSORS**

Curved, with insulation shanks
and universal diathermy
attachment

3898
145mm (5.3/4")

3899
180mm (7")

3900
230mm (9")



**TURNER WARWICK
NEEDLE HOLDER**

3901
Straight, right hand model,
black finish 215mm (8.1/2")



**TURNER WARWICK
NEEDLE HOLDER**

3902
Curved, right hand model,
black finish 215mm (8.1/2")



**TURNER WARWICK
NEEDLE HOLDER**

3903
Straight, left hand model,
black finish 215mm (8.1/2")



3905
Double ended
4/9 f.g and 7/12 f.g
1.33/3mm and 2.33/4mm



3906
Double ended
10/15 f.g and 13/18 f.g
3.33/5mm and 4.33/6mm



3907
Double ended
16/21 f.g and 19/24 f.g
5.33/7mm and 6.33/8mm



3908
Double ended
22/27 f.g and 25/30 f.g
7.33/9mm and 8.33/10mm

TURNER - WARWICK METAL DILATORS

3904

Set of comprising of:

- 1 x 3905
- 1 x 3906
- 1 x 3907
- 1 x 3908
- 1 x 3909



3909
Double ended
28/33 f.g and 31/36 f.g



MILLIN

3910
235mm (9.1/4")
Lobe grasping forceps



MILLIN

3911
245mm (9.3/4")
Lobe grasping forceps



MILLIN

3912
240mm (9.1/2")
Bladder neck spreader



**CUNNINGHAM
PENILE CLAMPS**
With foam rubber lining

3913
Small

3914
Medium

3915
Large



**THOMPSON-WALKER
PENILE CLAMP**

3916
115mm (4.1/2")



PENILE CLAMP

3918
130mm (5.1/8")

MOULDED RUBBER SHEATHS

3917



RANDALL
Renal Calculus Forceps

3919
A
230mm (9")



3920
B
200mm (8")



3921
C
195mm (7.3/4")



3922
D
180mm (7")



BLADDER SPATULA

3923
235mm (9.3/4")
Blade: 91mm x 61mm



MILLIN

3924
245mm (9.3/4")
Ligature holding forceps



**GABRIEL METAL AND GLASS
SYRINGE SET**

Consisting of

- 3925 Gabriel needle, straight
- 3926 Gabriel needle, angled
- 3927 Gabriel syringe, 10ml



GABRIEL NEEDLES
Diameter: 0.9mm

3928
75mm (3")
Straight

3929
100mm (4")
straight

3930
100mm (4")
Angled



GABRIEL SYRINGES

3931
3ml

3932
10ml

**GABRIEL METAL AND GLASS
SYRINGE SET**

- 3928** Gabriel needle, straight
- 3929** Gabriel needle, straight
- 3930** Gabriel needle, angled
- 3931** Gabriel syringe, 3ml
- 3932** Gabriel syringe, 10ml

PROCTOLOGY HAEMORRHOIDAL IGATORS

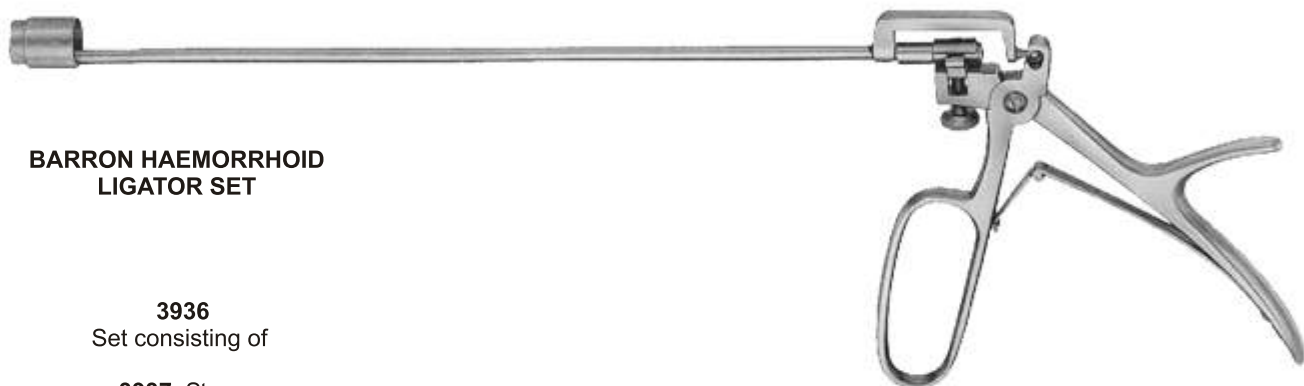
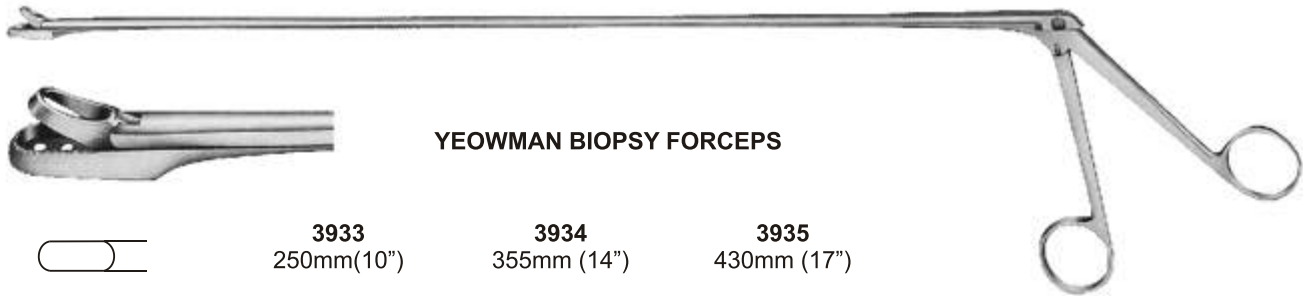

- 3936**
Set consisting of
- 3937** Stem
- 3938** "O" Ring
- 3939** Conical loader for "O" Ring
- 3940** universal Handle
- 3941**
215mm (8.1/2")
Stem Only
- 3942**
Pack of 300
"O" Rings
- 3943**
Conical loader only
- 3944**
Universal handle

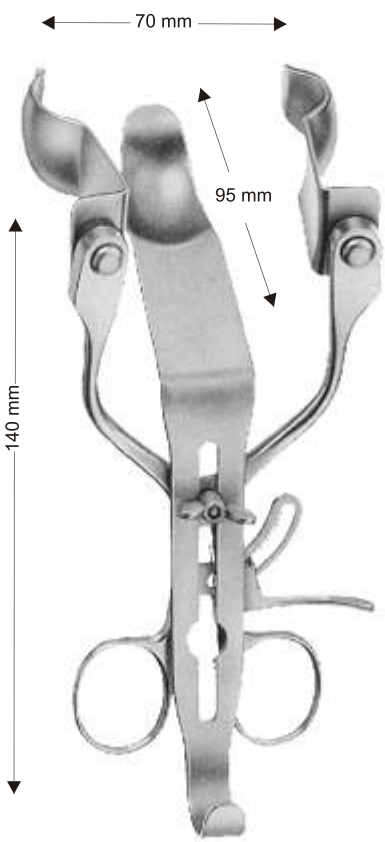

- PARK ANAL AND SPHINCTERECTOMY RETRACTOR**
- 3945**
Complete with:
Centre Blade: 95mm
Pair Blades: 70mm 3923
Pair Blades: 93mm 3924
 - 3946**
Spare Blades 70mm
 - 3947**
Spare Blades 93mm

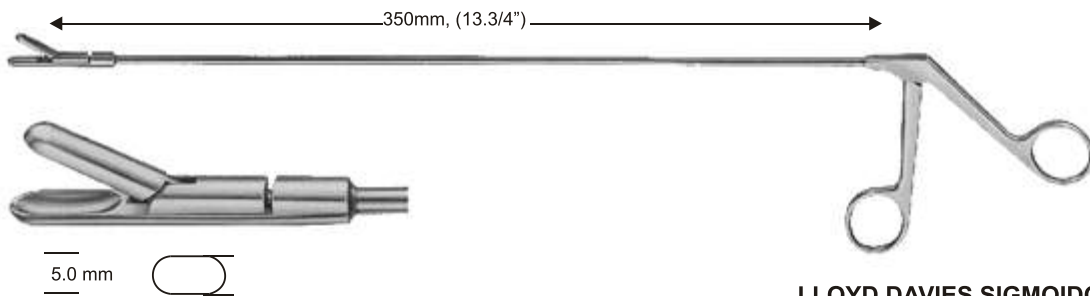

**LLOYD DAVIES SIGMOIDOSCOPE
BIOPSY FORCEPS**

3948
350mm (13.3/4")



**OFFICER
BIOPSY FORCEPS**

3949
430mm (17")
Jaws 8mm

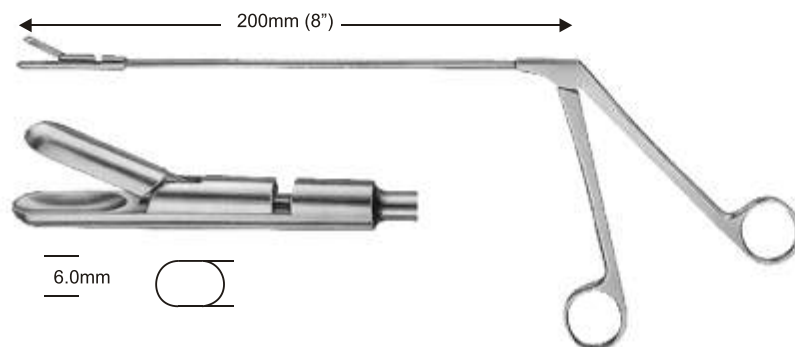

**WALTON RECTAL
BIOPSY FORCEPS**

3950
200mm (8")
Laterally angled shanks

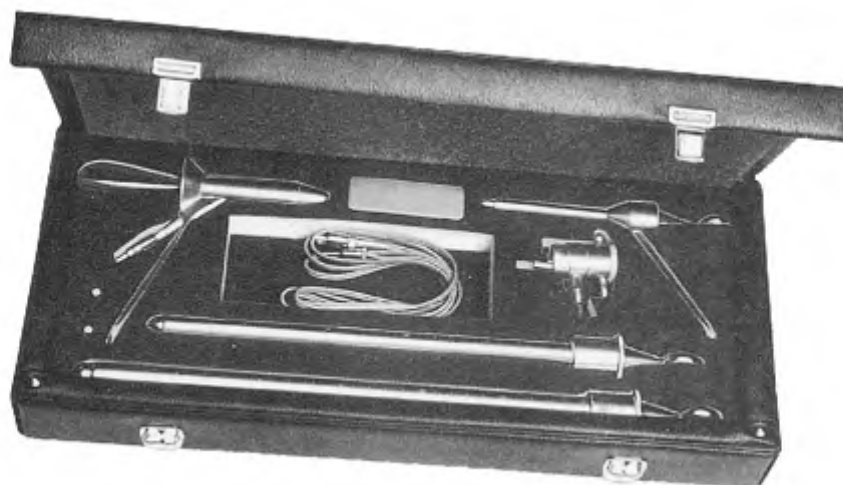

**LLOYD DAVIES (ST MARKS PATTERN)
MAJOR SIGMOIDOSCOPE AND
PROCTOSCOPE SET**

3951
Set of consisting
Naunton Morgan Rectal Speculum (17mm)
Lloyd Davies Proctoscope (10mm)
Fibre light carrier
Lloyd Davies Sigmoidoscope (16mm)
Lloyd Davies Sigmoidoscope (20mm)
Case



**LLOYD DAVIES (ST MARKS PATTERN)
COMBINATION SIGMOIDOSCOPE SET**

3952
Consisting of
Fibre light carrier
Lloyd Davies Sigmoidoscope (16mm)
Lloyd Davies Sigmoidoscope (20mm)
Case



**GRAEME ANDERSON
RECTAL SPECULUM**

3953
190mm (7.1/2")
Diameter: 19mm



GABRIEL RECTAL SPECULUM

3954
64mm (2.1/2")
Diameter: 25mm

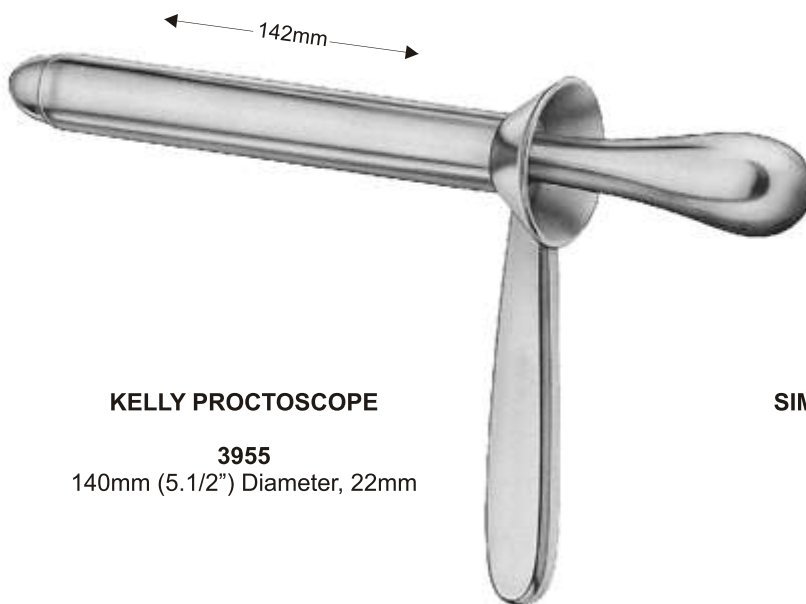

KELLY PROCTOSCOPE

3955
140mm (5.1/2") Diameter, 22mm

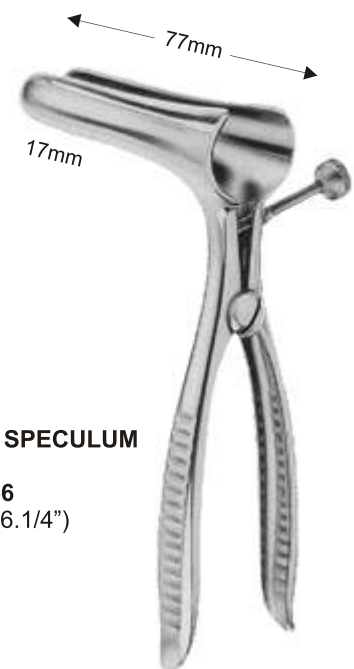

SIMS RECTAL SPECULUM

3956
160mm (6.1/4")



PRATT RECTAL SPECULUM

3957
205mm (8")



CZERNY RECTAL SPECULUM

3958
225mm (9")



MCEVEDY RECTAL SPECULUM WITH BATTERY HANDLE

3959
150mm (6") Diameter: 27mm

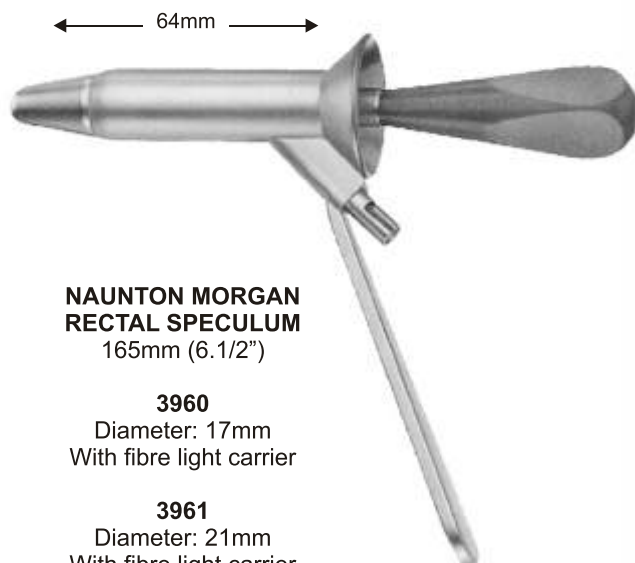

NAUNTUN MORGAN RECTAL SPECULUM
165mm (6.1/2")

3960
Diameter: 17mm
With fibre light carrier

3961
Diameter: 21mm
With fibre light carrier

3962
Diameter: 24mm
With fibre light carrier



3963



3964



3965



3966



3967



**GWILLIAM
HYSTERECTOMY**
200mm (8")

3963
Straight

3964
Curved



**HEANY
HYSTERECTOMY FORCEPS**
200m (8")

3965
Curved, single tooth



HEANY
3966
205mm (8")

3967
245cm (9.3/4")

PERITONEUM INSTRUMENTS

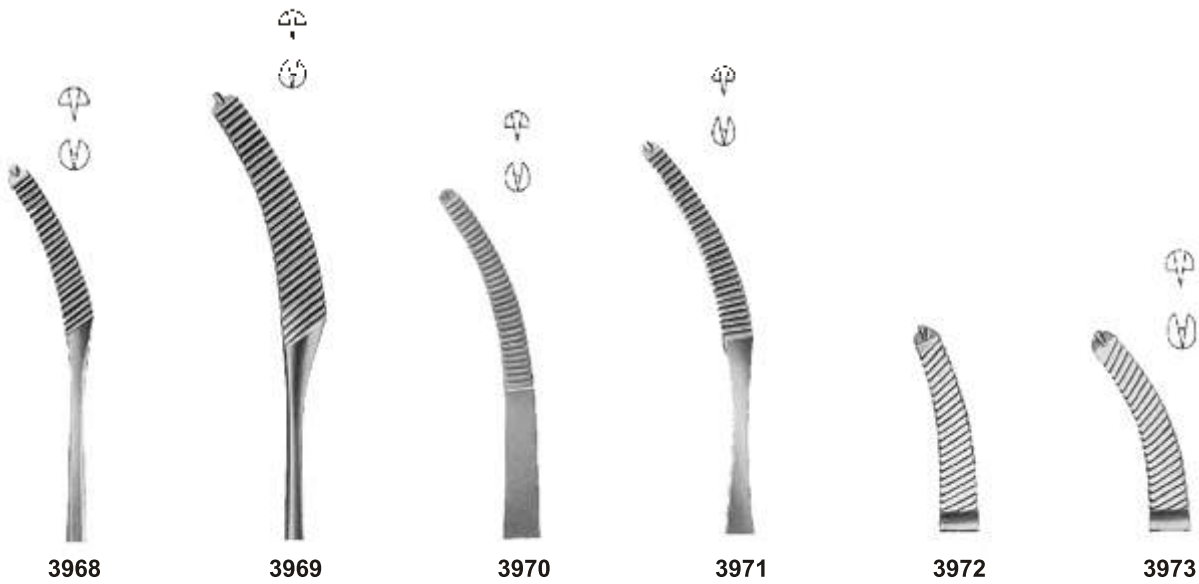

MIKULICZ
3968
180mm (7")

3969
205mm (8")



PERITONEUM
3970
205mm (8")

3971
205mm (8")



FAURE
3972
205mm (8")

3973
205mm (8")



I.U.D. REMOVING HOOK

3974
320mm (12.1/2")



WRIGLEY

3975
250mm (10")



KIELLAND

3976
402mm (16.3/4")



BARNES

3977
410mm (16")
With Simpson handles and
Neville axis traction rod



**FRENCH MODEL
PELVIMETER**

3978
330mm (13")
External and internal
Graduated to 50 and
22cms



**VACUME
EXTRACTION
SUCTION HEAD**

3979 40mm
3980 50mm
3981 60mm



AMNIOTOME

3982
240mm (9.1/2")



3983
140mm (5.1/2")
Pistol Grip



3984
140mm (5.1/2")
Pistol grip



Shaft only
3985 200mm (8")
3986 250mm (10")

Biopsy cutting



3987 ⊕

3988 ⊕



3989 ⊕



3990 △

CERVICAL BIOPSY FORCEPS

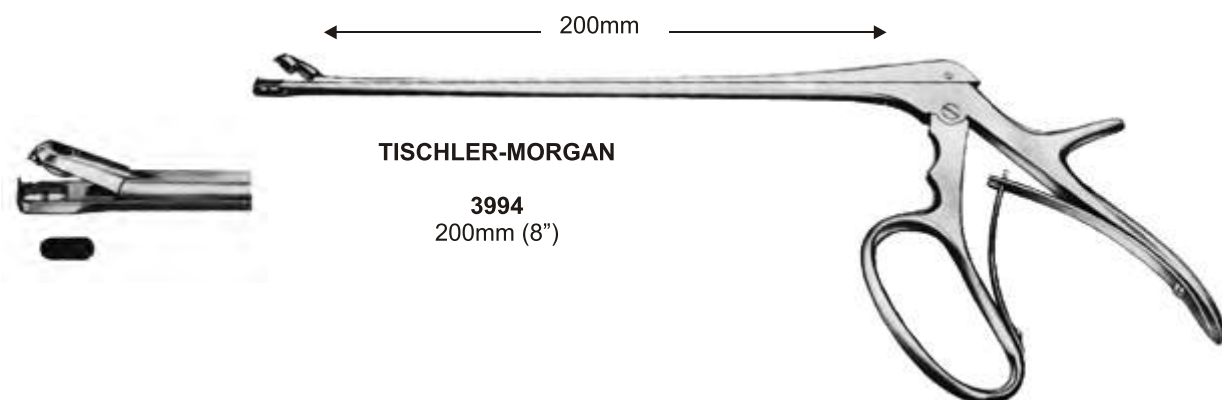
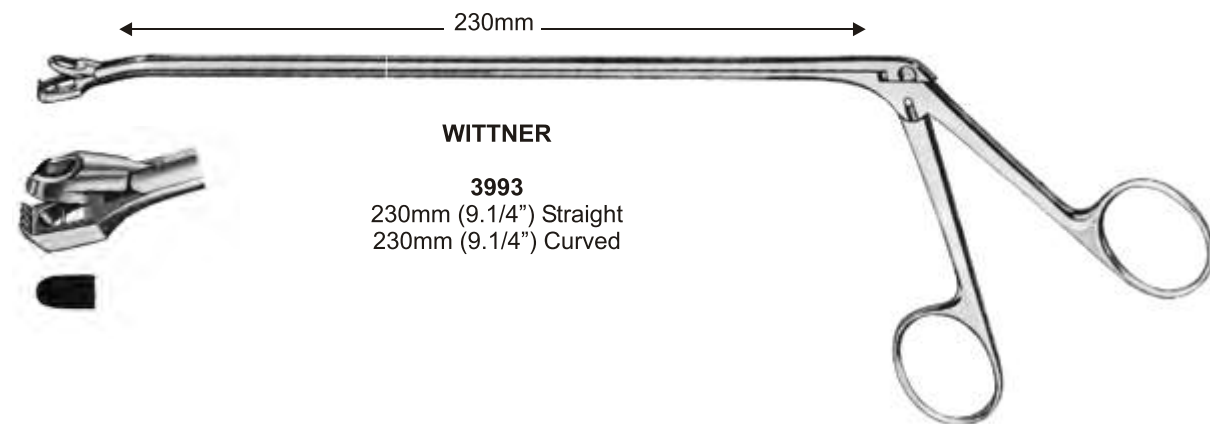
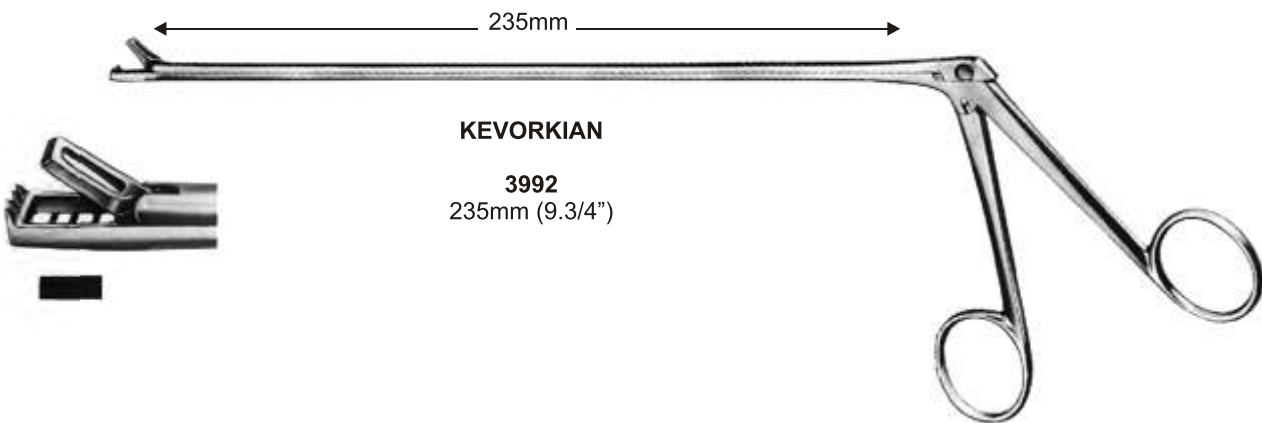
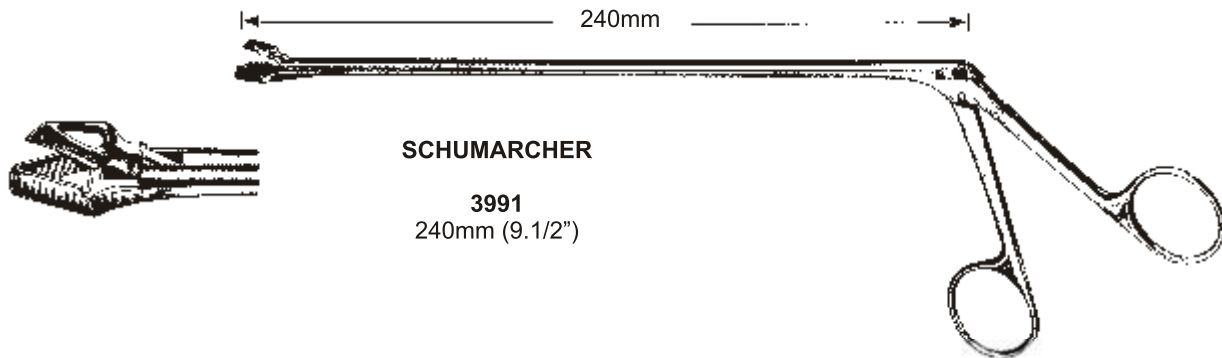



3983
140mm (5.1/2")
Pistol Grip



3984
140mm (5.1/2")
Pistol grip



Shaft only
3985 200mm (8")
3986 250mm (10")

Biopsy cutting



3987 ⊕

3988 ⊕



3989 ⊕



3990 △

CERVICAL BIOPSY FORCEPS

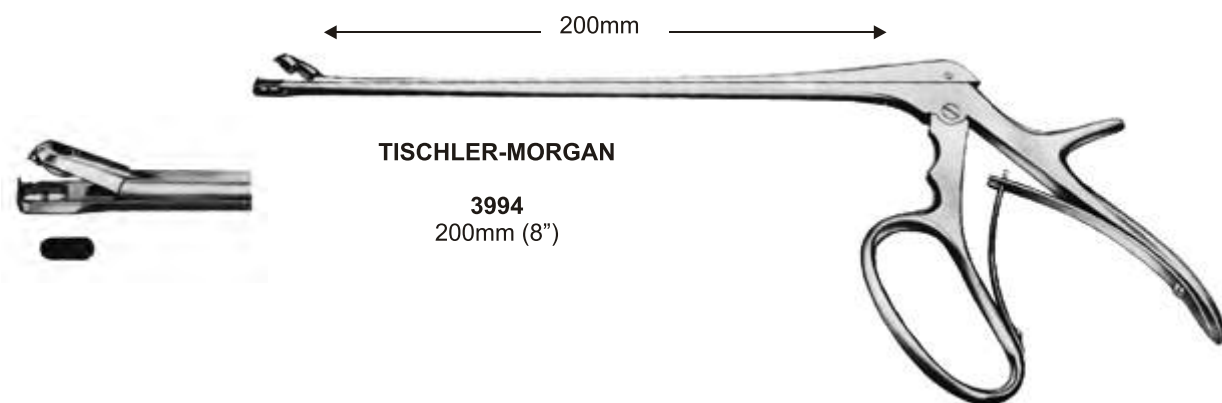
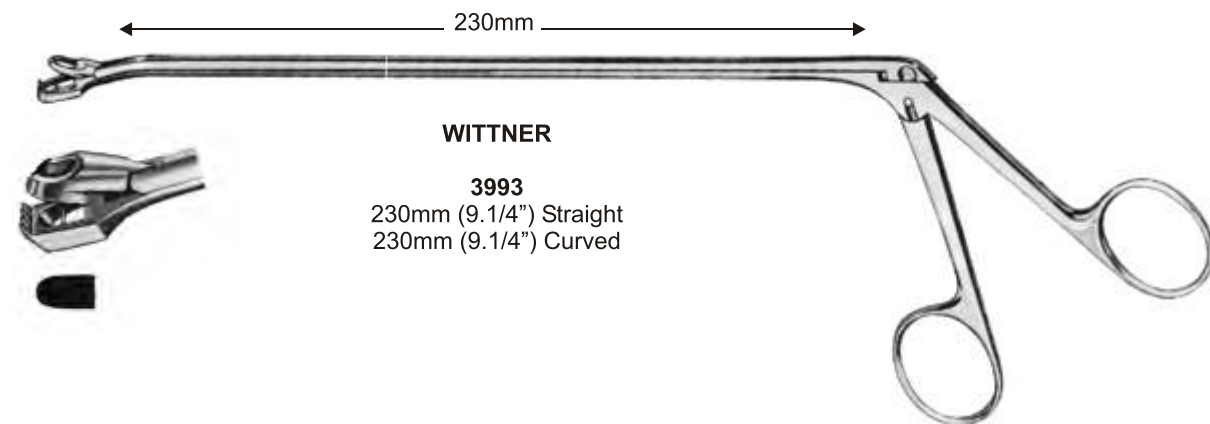
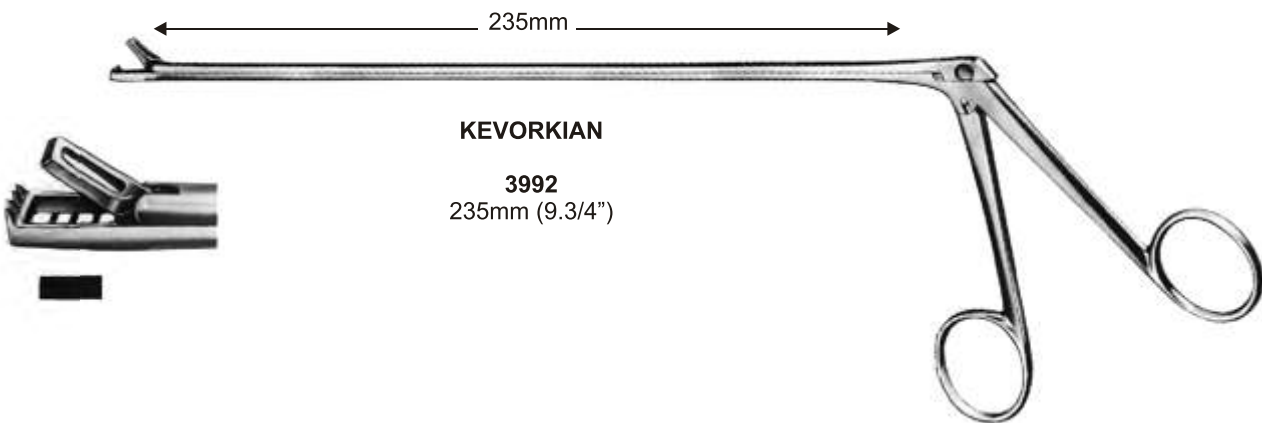
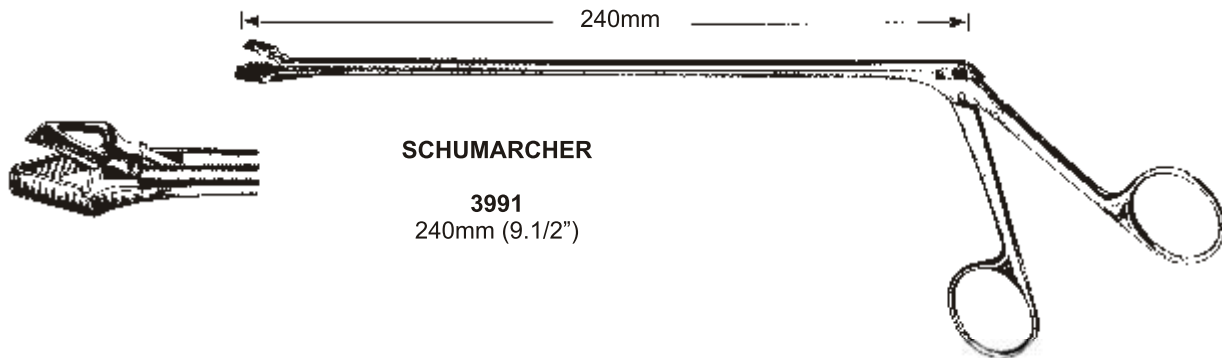



OVAL
7 x 5 mm

BURKE
3995
200mm (8")

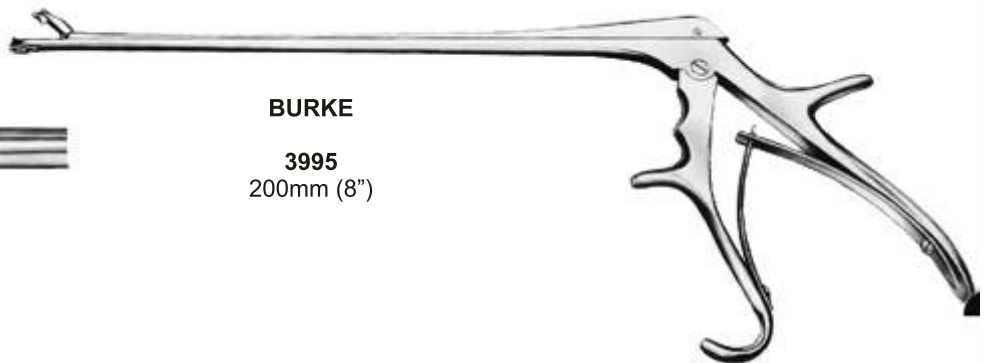

TISHLER-MORGAN

Fig.1



OVAL
3.7 x 5mm

Fig.3

TOWNSEND
3996
250mm (10")

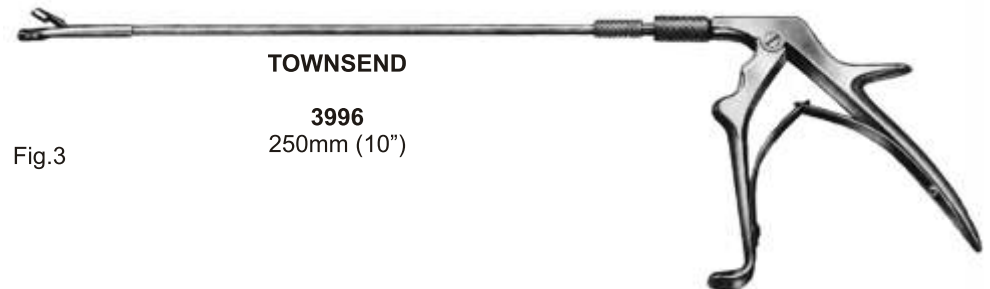

MINI

Fig.5



KEVORKIAN

Fig.4



3 x 8 mm

KEVORKIAN
3997
250mm (10")

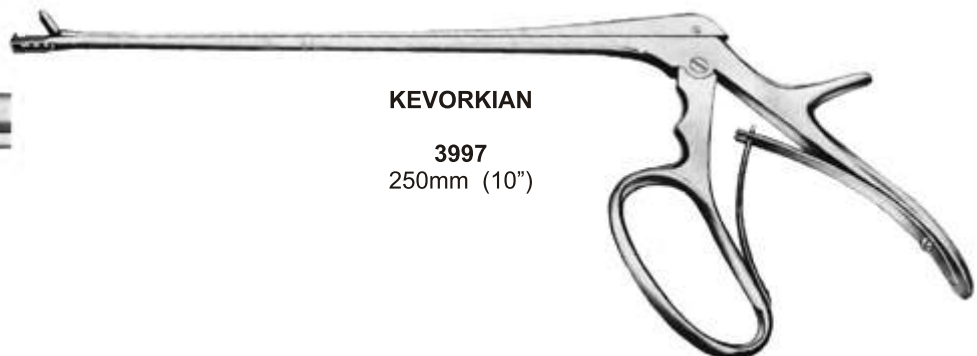

OVUM FORCEPS



DOYEN
3998
185mm (7.1/4")



3999
250mm (10")



BONNEY POLYPI
4000
240mm (9.1/2")



HEYWOOD SMITH

4001
240mm (9.1/2")



MCLINTOCK

4002
240mm (9.1/2")



NOTO

4003
280mm (11")

MALLETS



TUFNOL Mallet
250mm (10")

4004
Diameter: 35mm

4005
Diameter: 42mm

4006
Diameter: 50mm



4007
230mm (9")
Diameter: 35mm



4008
One metal disk, flat
One metal disk, convex



4009
One plastic disk, flat
One Plastic disk, Convex



4010
Wrench



LUCAE

4011
Diameter: 27mm
8.1/2 oz



KELSEY FRY

4012
190mm (7.1/2")
Diameter: 20mm

SPARE DISKS

4013
Spare disks for
Kelsey-Fry Mallet



HEATH

4014
Diameter: 25mm
28 oz

4015
Diameter: 40mm
36 oz

OSTEOTOMES, CHISELS & GOUGES

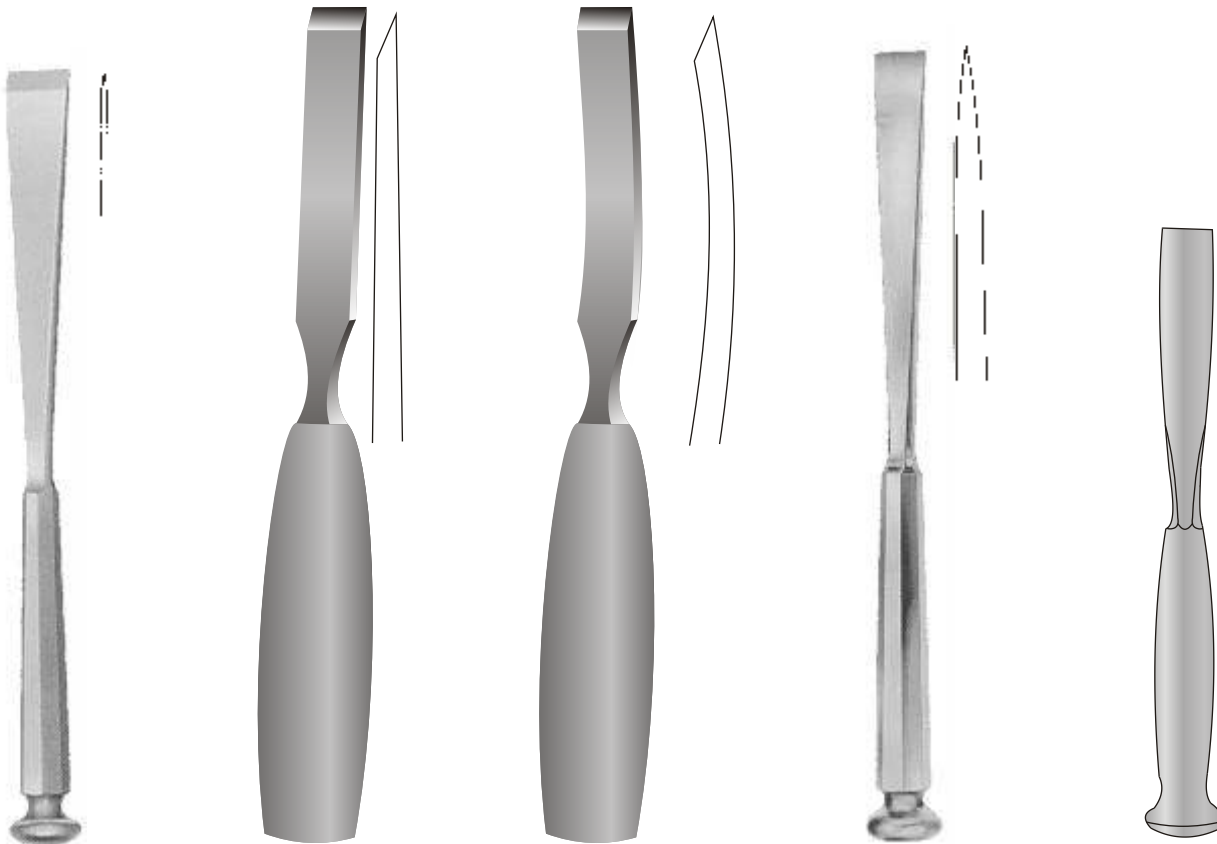

**SWEDISH MODEL
CHISELS**
200mm (8")
Straight

- 4016**
Width: 10mm
- 4017**
Width: 15mm
- 4018**
Width: 20mm
- 4019**
Width: 25mm
- 4020**
Width: 30mm

CAPENER CHISELS
255mm (10")
With Tufnal Handle
Straight

- 4021**
Width: 6mm
- 4022**
Width: 8mm
- 4023**
Width: 10mm
- 4024**
Width: 12mm
- 4025**
Width: 15mm
- 4026**
Width: 20mm
- 4027**
Width: 25mm
- 4028**
Width: 30mm

CAPENER CHISELS
255mm (10")
With Tufnal Handle
Curved

- 4029**
Width: 6mm
- 4030**
Width: 8mm
- 4031**
Width: 10mm
- 4032**
Width: 12mm
- 4033**
Width: 15mm
- 4034**
Width: 20mm
- 4035**
Width: 25mm
- 4036**
Width: 30mm

**SWEDISH MODEL
OSTEOTOME**
200mm (8")
Straight

- 4037**
Width: 10mm
- 4038**
Width: 15mm
- 4039**
Width: 20mm
- 4040**
Width: 25mm
- 4041**
Width: 30mm

**SMITH-PETERSON
OSTEOTOME**
200mm (8")
Straight

- 4042**
Width: 10mm
- 4043**
Width: 15mm
- 4044**
Width: 20mm
- 4045**
Width: 25mm
- 4046**
Width: 30mm

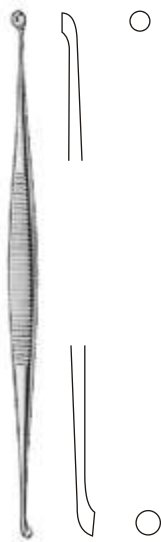

MARTINI
4047
140mm (5.1/2")



LEMPERT
200mm (8")*

4048
2mm x 3.5mm

4049
2mm x 4mm

4050
2.5mm x 4.5mm

4051
2.75mm x 5mm

4052
3mm x 5.5mm

4053
3.25mm x 6mm



COLLIER AND MORRIS
180mm (7")

4054
2mm x 3mm

4055
3mm x 4mm

4056
4mm x 5mm

4057
5mm x 6mm

RASPATORIES



VOLKMAN
170mm (6.3/4")

2.8mm 3.6mm 4.4mm 5.2mm 6.8mm

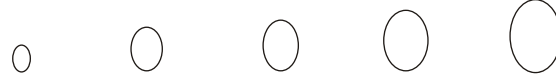

4058 4059 4060 4061 4062

8.5mm 10mm 11.5mm 13mm 14.5mm

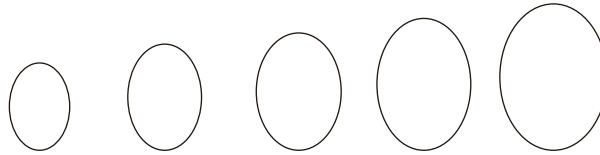

4063 4064 4065 4066 4067

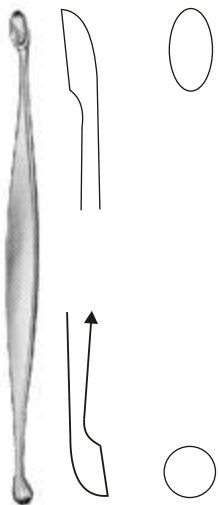

**BOYD
BONE CURETTE**
Oval, double ended
4068
130mm (5.1/8")

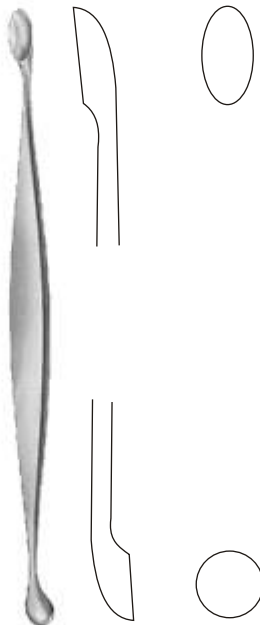

**BOYD
BONE CURETTE**
Oval, double ended
4069
160mm (6.1/4")

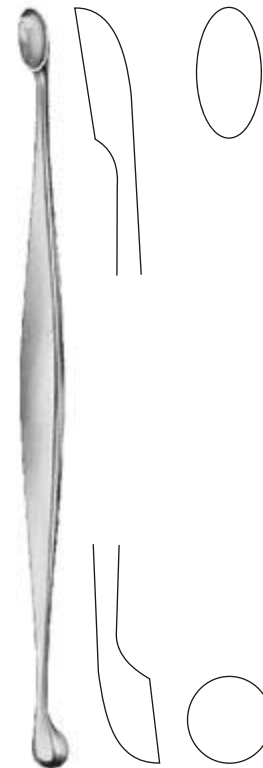

**BOYD
BONE CURETTE**
Oval, double ended
4070
200mm (8")

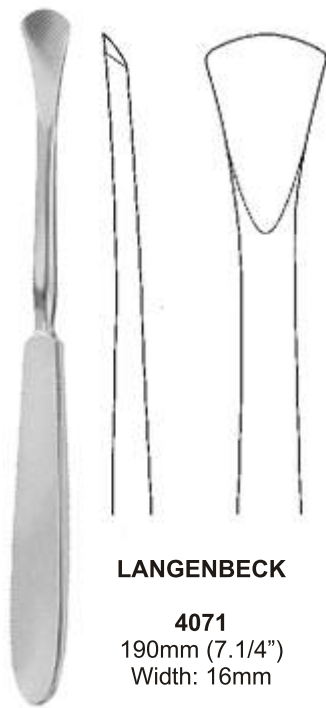

LANGENBECK

4071
190mm (7.1/4")
Width: 16mm



MCKISSOCK

4072
195mm (7.3/4")

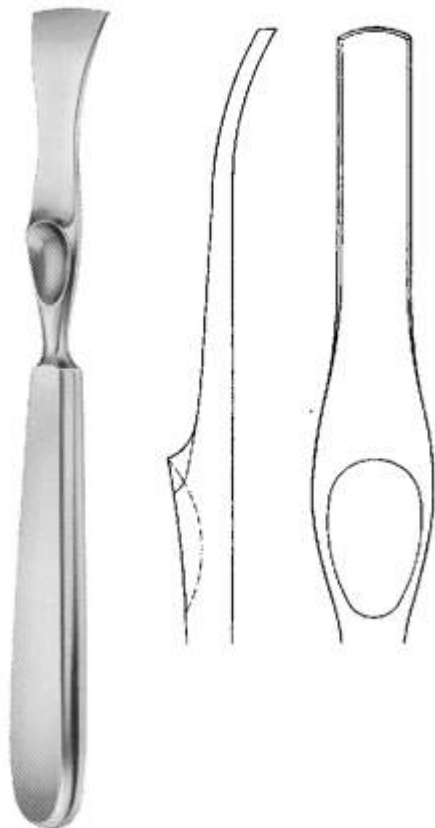

LAMBOTE
215mm (8.1/2")

4073
Width: 5mm

4074
Width: 10mm

4075
Width: 15mm

4076
Width: 20mm

4077
Width: 25mm



BRISTOW
4078
230mm (9")

RASPATORIES

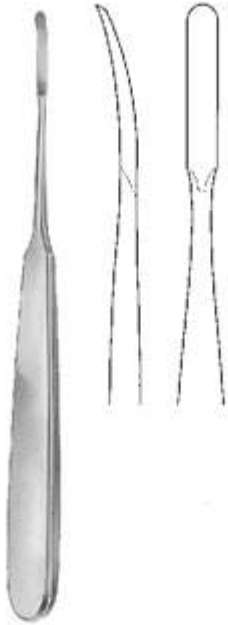

JOSEPH

4079
170mm (6.3/4")
Width at tip: 4mm



MACDONALD

4080
185mm (7.1/4") blunt

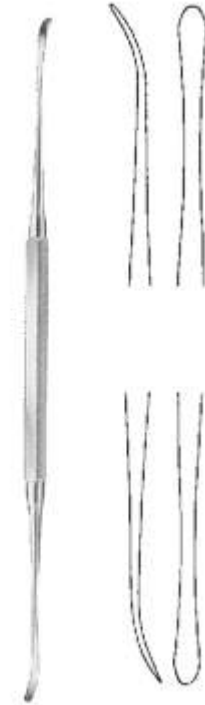

FREER ELEVATOR

4081
190mm (7.1/2"), double ended



ADSON

165mm (6.1/2"), curved

4082 width 5mm
4083 width 7mm



ADSON

165mm (6.1/2") slight curve
4084 Width 7mm



PENNYBACKER

150mm (6")
4085 Width 6mm



**"COBRA"
HIP LEVER**

4086
235mm (9.1/4")
Max Width: 65mm
Width at tip: 25mm

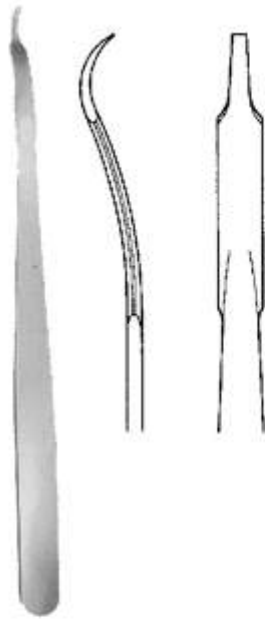

MINI-HOHMANN

4087
160mm (6.1/4")
Max width: 6mm
Width at tip: 2mm

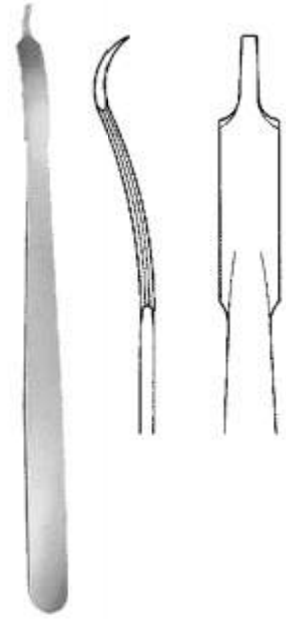

MINI-HOHMANN

4088
160mm (6.1/4")
Max width: 8mm
Width at tip: 2mm

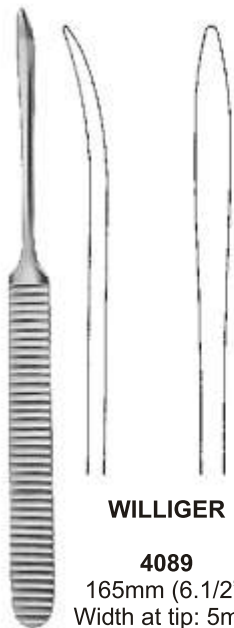

WILLIGER

4089
165mm (6.1/2")
Width at tip: 5mm

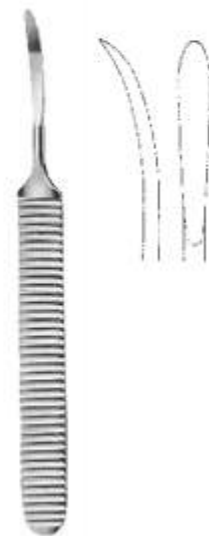

WILLIGER

4090
140mm (4.1/2")
Width at tip: 4mm

BONE LEVERS

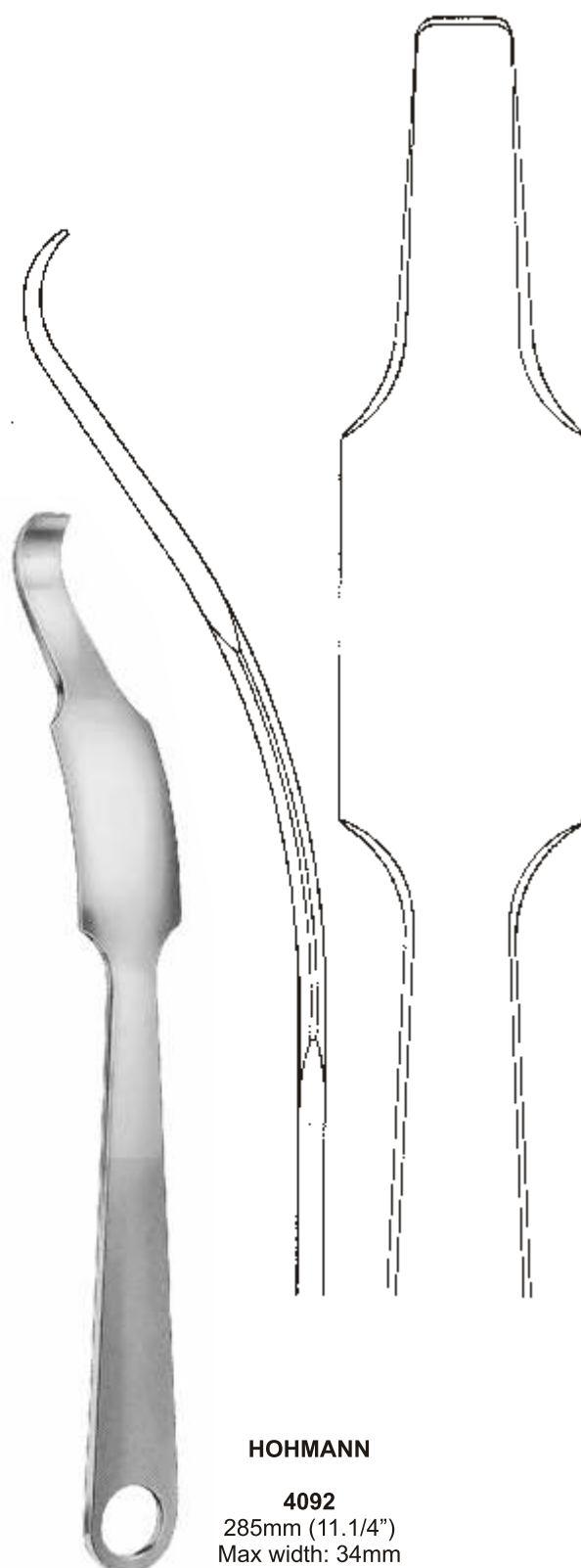
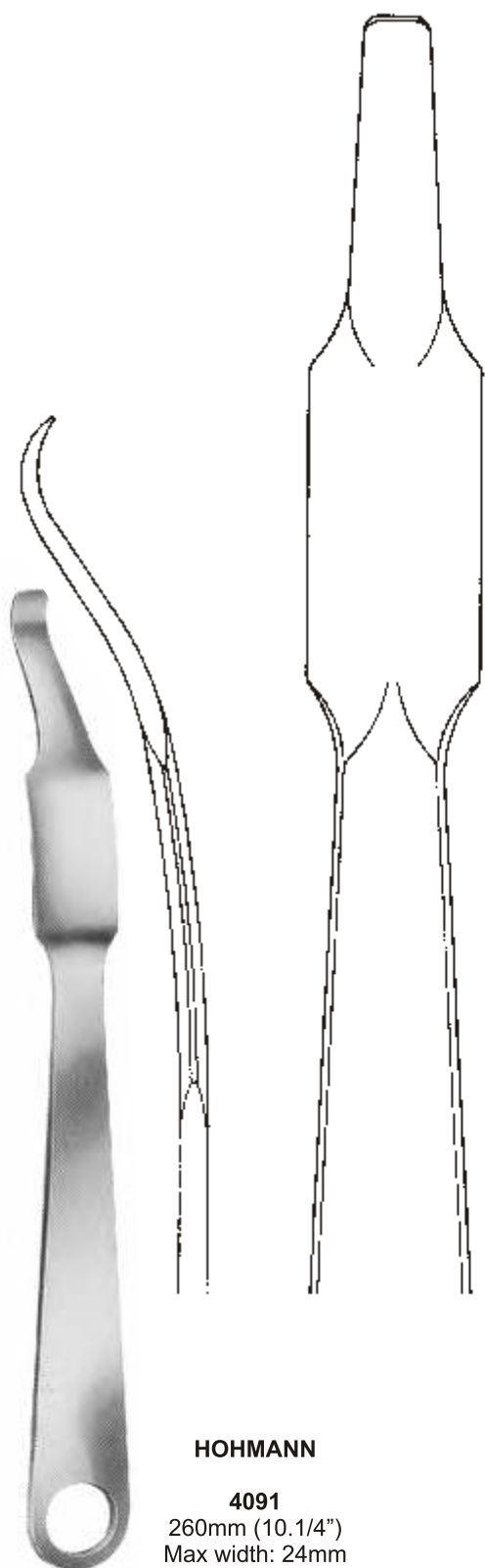



ST THOMAS



4093
180mm (7")
Pointed end



4094
180mm (7")
Rounded end



**CAIRNS SKULL FLAP
ELEVATOR**

4095
180mm (7")



**TRETHOWAN
BONE LEVER**

4096
215mm (8.1/2")



**LANE
BONE LEVER**

4097
255mm (10")



**PERCY AMPUTATION FLAP
RETRACTOR**

4098
Removable handles



AMPUTATION SAW
With hinged back
to take apart
4099
Blade: 230mm (9")

5000
Spare blade for
amputation saw



FINGER SAW
5001
200mm (8")



**ARMY REGULATION
AMPUTATION SAW**

5002
Blade: 180mm (7")
With hinged back
to take apart



LISTON

5003

Blade: 130mm (5.1/8")

5004

Blade 220mm (8.3/4")



LANGENBECK

5005

Resection knife

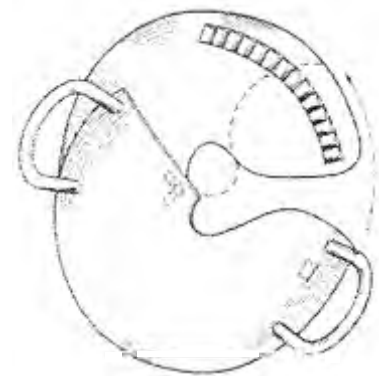

**BLAKE AMUPTATION FLAP
RETRACTOR**

5006

Diameter: 240mm (9.1/2")

SUCTION TUBES

FRAZIER

5007

185mm (7.1/4") Diameter 2.33mm 7.f.g

5008

185mm (7.1/4") Diameter 2.66mm 8 f.g

5009

185mm (7.1/4") Diameter 3mm 9.f.g



ADSON FRAZIER

180mm (7")

5010 Diameter 2mm

5011 Diameter 2.5mm

5012 Diameter 3mm

5013 Diameter 4mm

5014 Diameter 5mm



ADSON

180mm (7")

5015 Diameter 3mm

5016 Diameter 5mm



CONE SUCTION TUBES

5017

Set comprising of one of each of the following items except 3498



SUCTION TUBES

5018 Diameter: 3mm

5019 Diameter: 4mm

5020 Diameter: 5mm



HANDLE

5021 100mm (4")
with Tucker value

BARRON

5022
230mm (9")
Diameter: 1.33mm



BELUCCI

5023
Set comprising of each of the following items:

BELUCCI SUCTION TUBE

5024
170mm (6.3/4") Diameter: 2mm



ZOELLNER DETACHABLE ENDS

5025 20 s.w.g
5026 22 s.w.g
5027 24 s.w.g

FORMBY

5028
210mm (8.1/4")
Diameter: 3.3mm

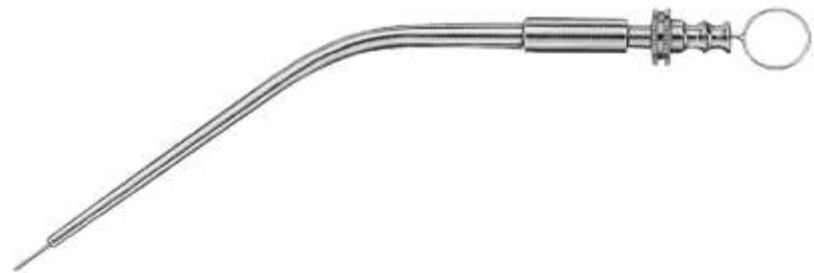

HOUSE

Shaft: 90mm (3.1/2")
Suction and irrigation tube

5029

Diameter suction tube: 0.9mm
Diameter irrigating tube: 0.7mm

5030

Diameter suction tube: 1.2mm
Diameter irrigating tube: 0.9mm

5031

Diameter suction tube: 1.5mm
Diameter irrigating tube: 1.2mm



ATRAUMA CARDIOVASCULAR FORCEPS

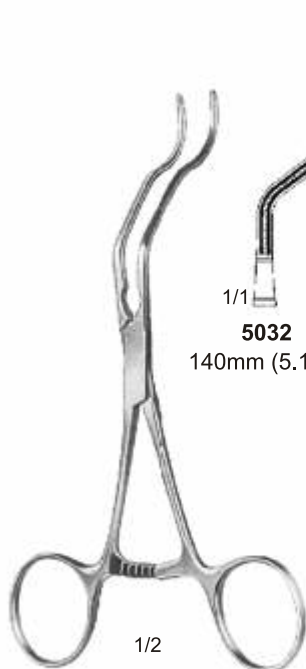

5032
140mm (5.1/2")

GREGORY



5033
160mm (6.1/4")

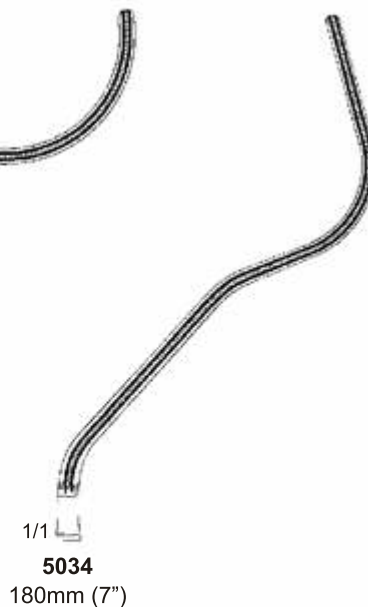

5034
180mm (7")

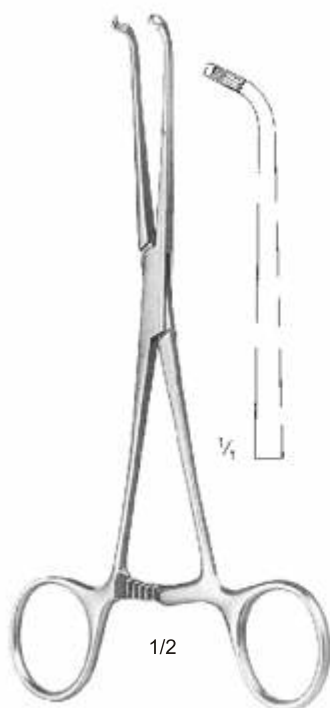

JAVID

5035
180mm (7")

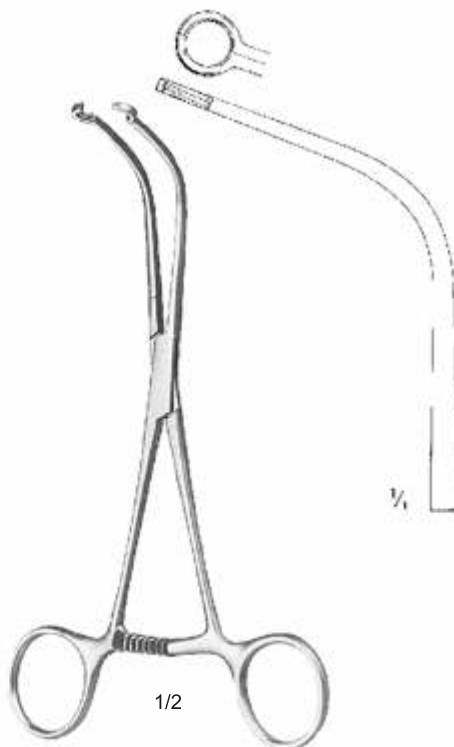

JAVID

5036
190mm (7.1/2")



1/2

DALE
5037
185mm (7")

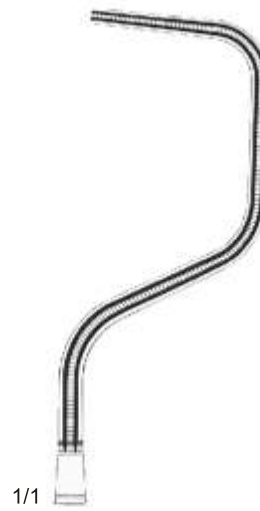

1/1



1/2

DALE



1/1

5038
170mm (6.1/2")



1/1

5039
175mm (7")

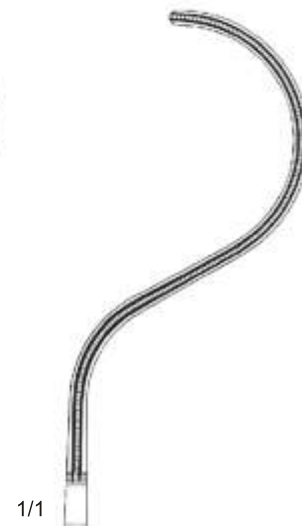

1/1

5040
185mm (7.1/4")

ATRAUMA BULLDOG CLAMPS



1/1

DE-BAKEY SATINSKY

5041
70mm (2.3/4")



1/1

DE BAKEY-CAROTIS

5042
90mm (3.1/2")

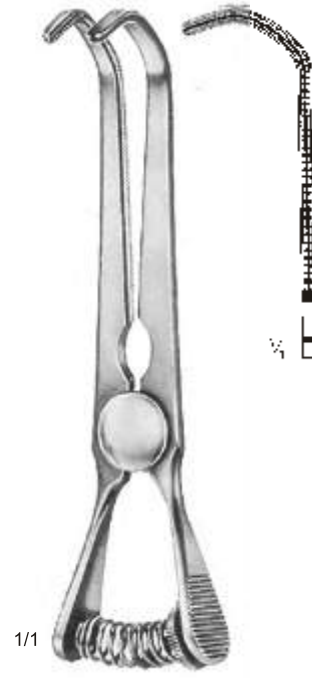

1/1

DE BAKEY SATINSKY

5043
100mm (4")

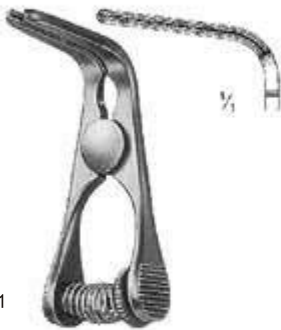

1/1

GLOVER

5044
50mm (2")



1/1

SANTULLI

5045
70mm (2.3/4")

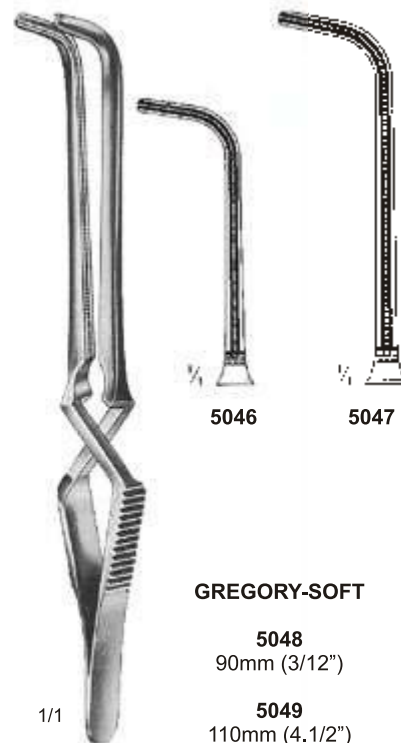

1/1

GREGORY-SOFT

5048
90mm (3/12")

5049
110mm (4.1/2")

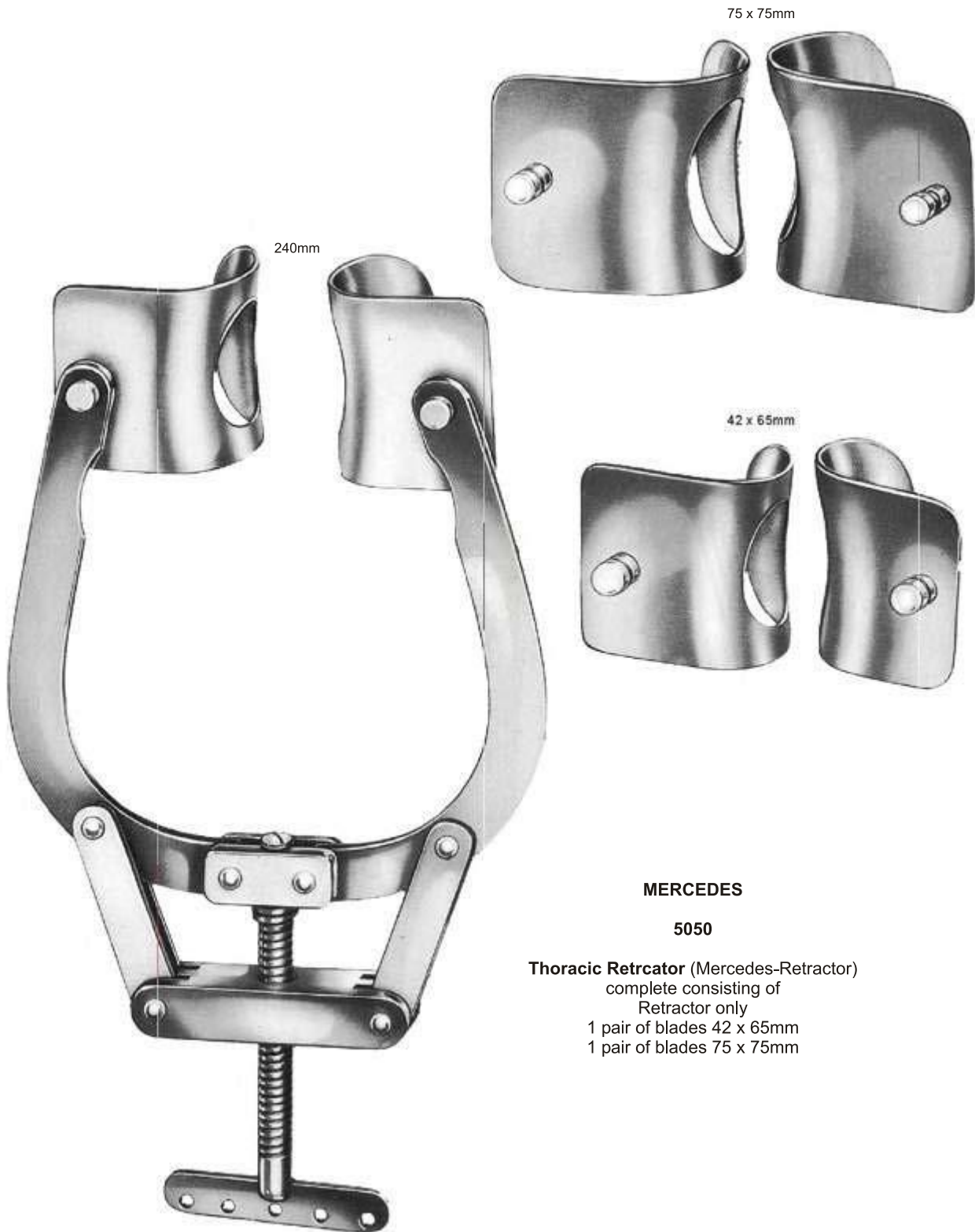

MERCEDES

5050

Thoracic Retractor (Mercedes-Retractor)
complete consisting of
Retractor only
1 pair of blades 42 x 65mm
1 pair of blades 75 x 75mm

RIB SPREADERS

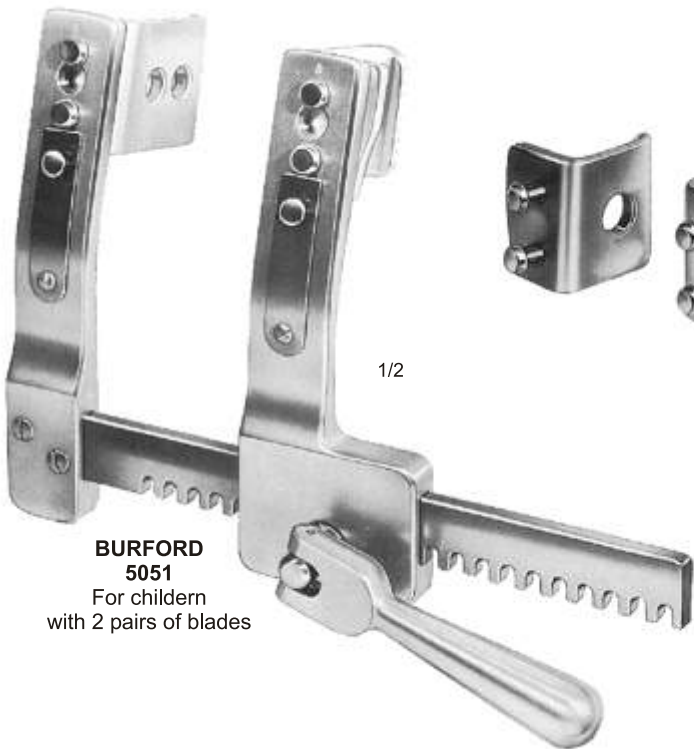

1/2

BURFORD 5051
For children
with 2 pairs of blades



a	b	c
48mm	42mm	135mm
34mm	42mm	135mm

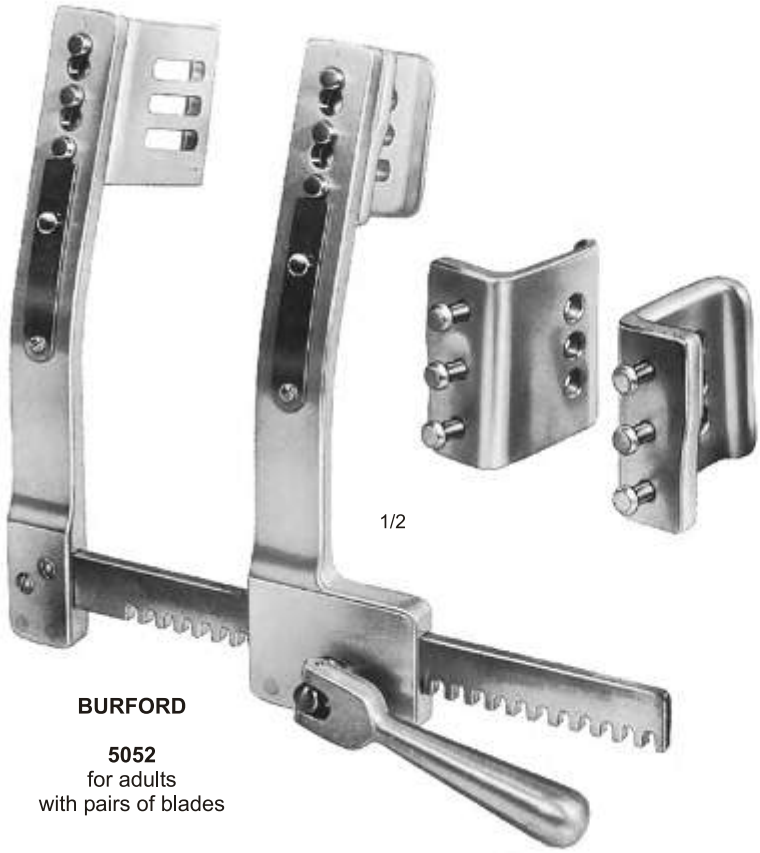

1/2

BURFORD 5052
for adults
with pairs of blades



a	b	c
64mm	62mm	180mm
47mm	62mm	
65mm	62mm	260mm
47mm	62mm	
65mm	62mm	300mm
47mm	62mm	

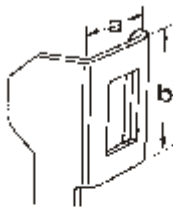

COOLEY

5053
For new borns

A	B	C
12 mm	16 mm	95 mm

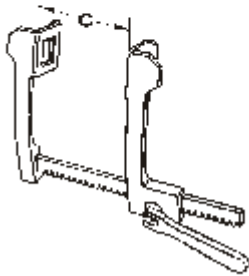

COOLEY

5054
Pediatric size

A	B	C
15 mm	30 mm	140 mm
21 mm	44 mm	150 mm



COOLEY

5055
For adults

A	B	C
35 mm	50 mm	200 mm

BONE & RIB SHEARS



5056
230mm (9")



5057
220mm(8.3/4")



5058
170mm (6.3/4")



GLUCK
5059
220mm (8.3/4")

With eccentric
sliding blade



STILLE
5060
210mm (8.1/4")



PLASTER SHEARS

5061
160mm (6.1/4")



PLASTER SHEARS

5062
200mm (8")

5063
230mm (9")



PLASTER SHEARS

5064
235mm (9.1/4")

BONE CUTTING FORCEPS

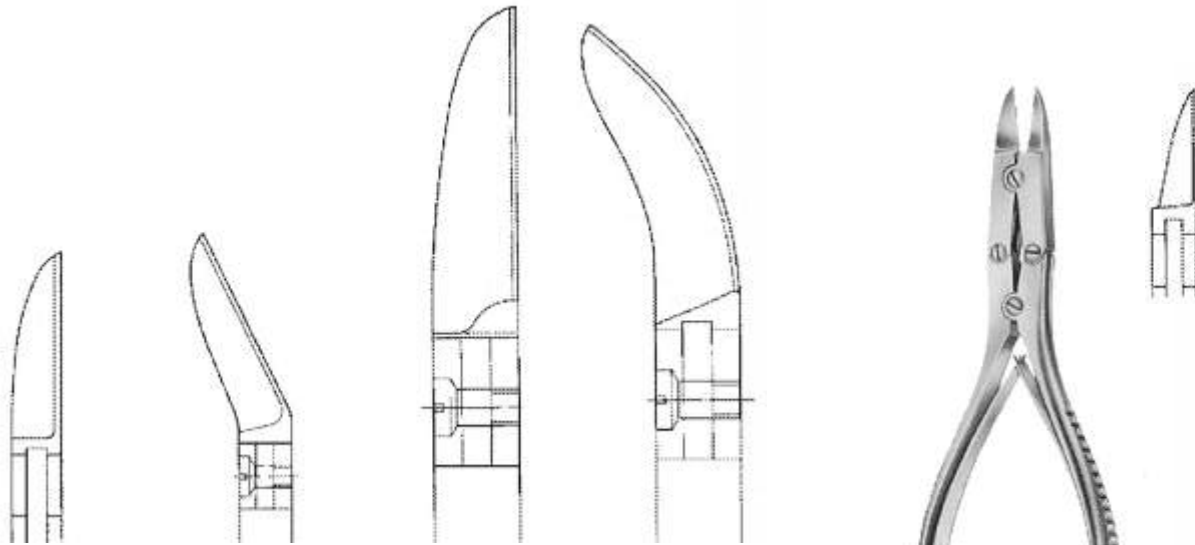

5069
150mm (6")



RUSKIN - LISTON

5065
190mm (7.1/2")
Straight

5066
190mm (7.1/2")
Angled on flat



STILLE LISTON

5067
280mm (11")
Straight

5068
275mm (10.3/4")
Curved on flat



5070
145mm (5.3/4")

BECK RONGEUR

5071
Shaft: 130mm (5.1/8")
2mm bite



CUSHING (CAIRNS) RONGEUR

Shaft: 130mm (5.1/8")

5072
4mm bite

5073
5mm bite

5074
7mm bite



CUSHING RONGEURS

Shaft: 130mm (5.1/8")

5075
3mm bite

5076
4mm bite

5077
5mm bite



CUSHING RONGEURS

Shaft 130mm (5.1/8")

5078
3mm bite

5079
4mm bite



BONE RONGEURS



SARGENT (VAN HAVRE)

5080
220mm (8.3/4")
10mm bite



OLIVECRONA

5081
230mm (9")
6mm bite



STILLE-RUSKIN

5082
240mm (9.1/2")



BONE RONGEURS



BEYER

5090
150mm (6")
5mm bite



**JANSEN-MIDDLETON
SEPTUM FORCEPS**

5091
200mm (8") Spoon shaped
4mm bite



CAIRNS

5092
140mm (5.1/2")
4mm bite



CAIRNS

5093
140mm (5.1/2")
4mm bite



LUER

5094
155mm (6")



RUSKIN

5095
190mm (7.1/2")
6mm bite



5096
250mm (9.3/4")



5097
255mm (10")



5098
175mm (7")

VERBRUGGE



VERBRUGGE



5099
265mm (10.1/2")



LEWIN

6000
135mm (5.1/4")

TUNNELING SET



6001
Complete Set



6002
6 mm



6003
8mm



6004
10mm



6005
12mm



6006



6007

110mm x 37mm
80 mm x 32mm
80 mm x 24mm

- 6001** Tunneling set complete
- 6008** Universal Handle (2x)
- 6009** Tunneling shaft, curved, 225mm
- 6010** Tunneling shaft, straight, 225mm
- 6011** Tunneling shaft, curved, 540mm
- 6002** Bullet tip 6mm (2 x)
- 6003** Bullet tip 8mm (2 x)
- 6004** Bullet tip 10mm (2 x)
- 6005** Bullet tip 12mm (2 x)
- 6006** Vein tip
- 6007** Luer Adaptor
- Plate for tips only
- Sterilizing cases 550 x 115 x 35mm



6008

6009
225mm



6010
225mm



6011
540mm

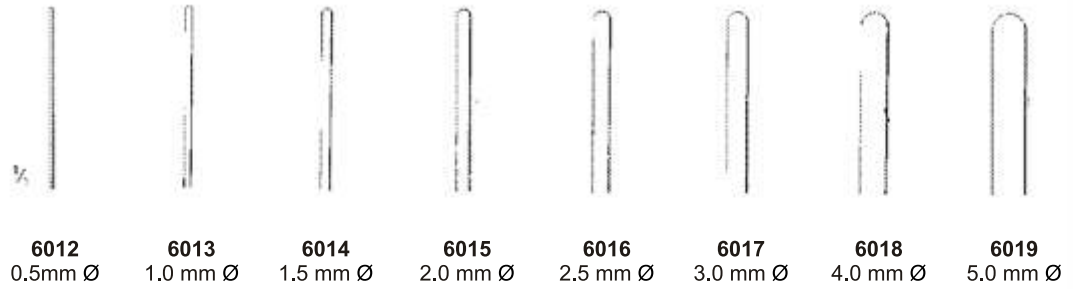

6012 0.5mm Ø **6013** 1.0 mm Ø **6014** 1.5 mm Ø **6015** 2.0 mm Ø **6016** 2.5 mm Ø **6017** 3.0 mm Ø **6018** 4.0 mm Ø **6019** 5.0 mm Ø

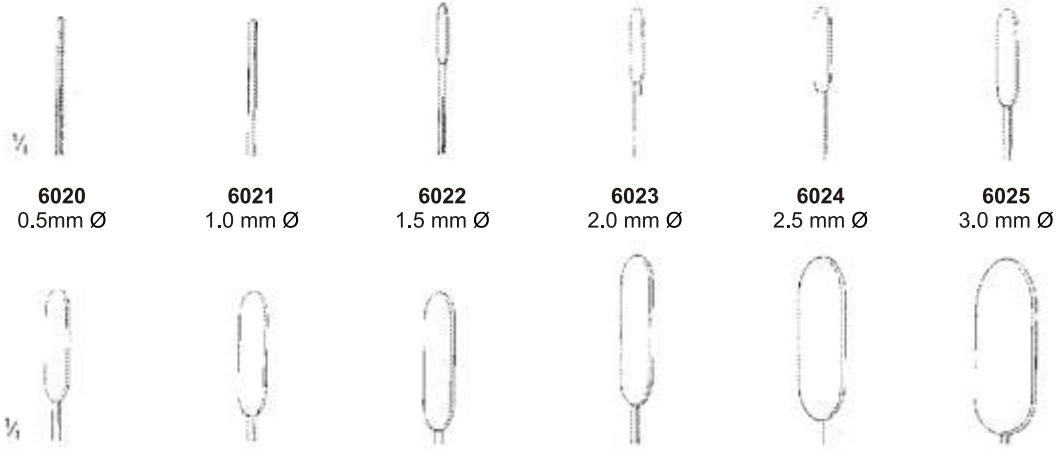

6020 0.5mm Ø **6021** 1.0 mm Ø **6022** 1.5 mm Ø **6023** 2.0 mm Ø **6024** 2.5 mm Ø **6025** 3.0 mm Ø



6026 3.5 mm Ø **6027** 4.0 mm Ø **6028** 4.5 mm Ø **6029** 5.0 mm Ø **6030** 7.0 mm Ø **6031** 9.0 mm Ø

DILATORS

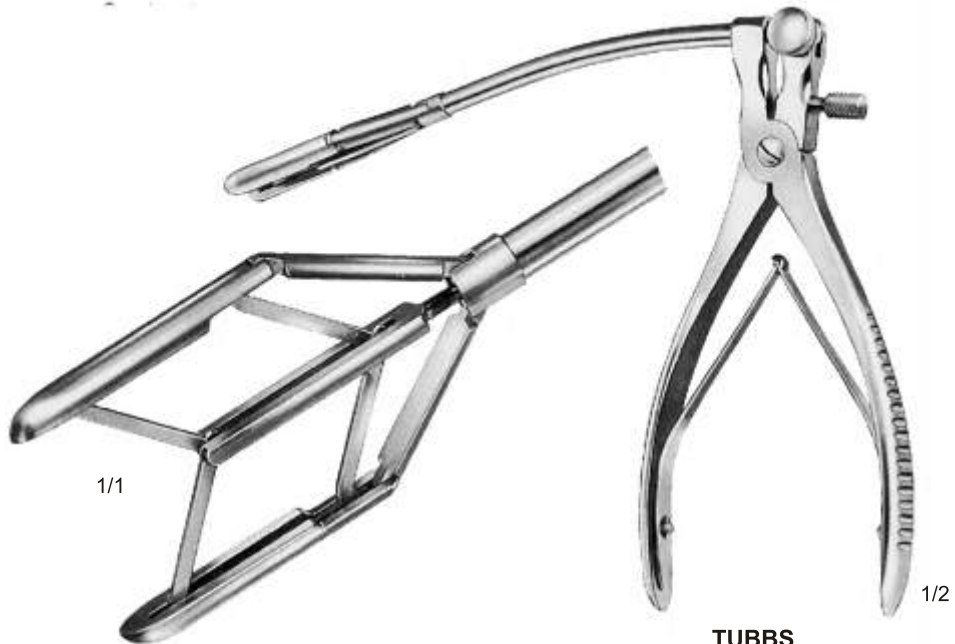

TUBBS
6032
Blade opening from 8 to 42mm

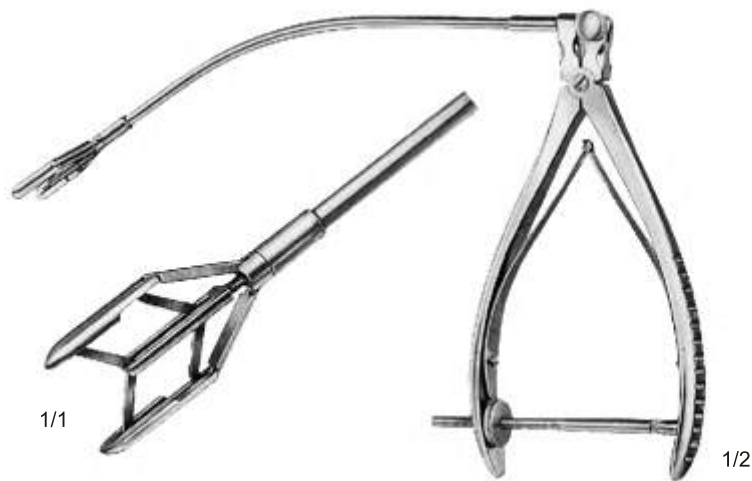

COOLEY
6033
Blade opening from 8 to 15mm

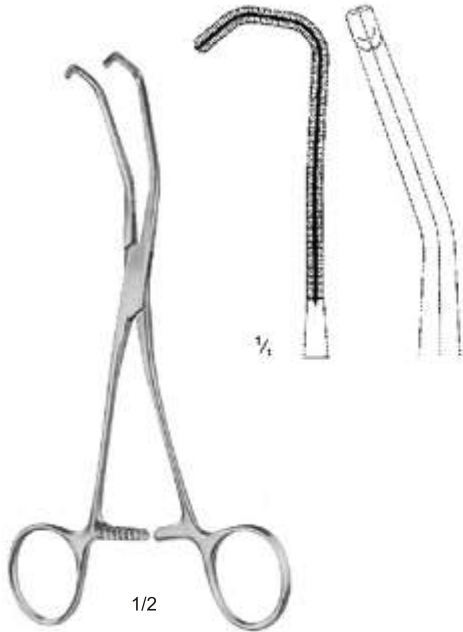

**COOLEY
6034**
170mm (6.3/4")



**COOLEY
6035**
160mm (6.1/4")



**COOLEY
6036**
150mm (6")

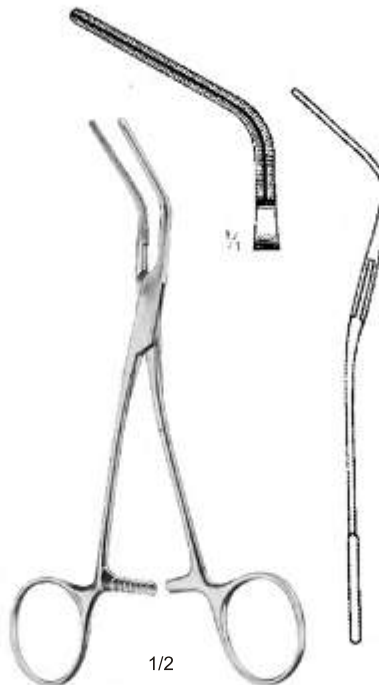

**COOLEY
6037**
155mm (6.1/4")

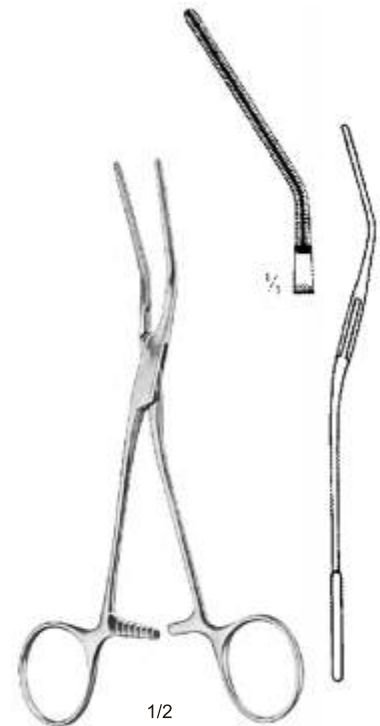

**COOLEY
6038**
170mm (6.3/4")

ATRAUMA CARDIOVASCULAR FORCEPS



**DE BAKEY
6039**
100mm (4")

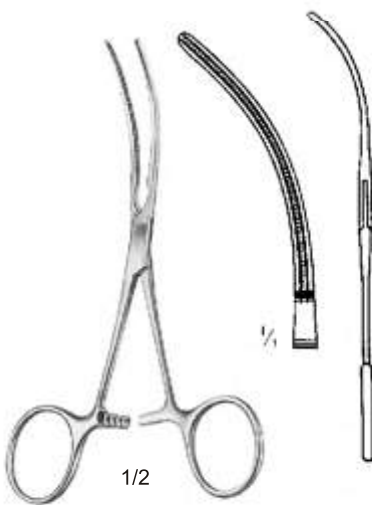

**DE BAKEY
6040**
110mm (4.1/4")

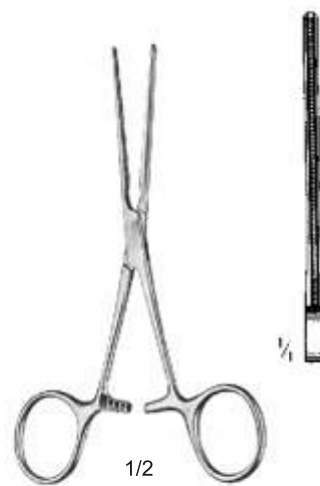

**DE BAKEY
6041**
120mm (4.3/4")



**DE BAKEY
6042**
120mm (4.3/4")



**DE BAKEY
6043**
130mm (5.1/4")

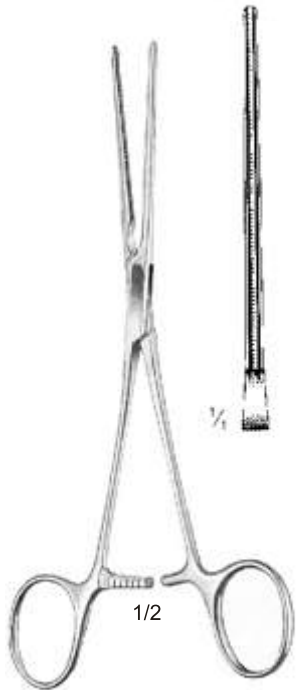

**DE BAKEY
6044**
170mm (6.1/4")

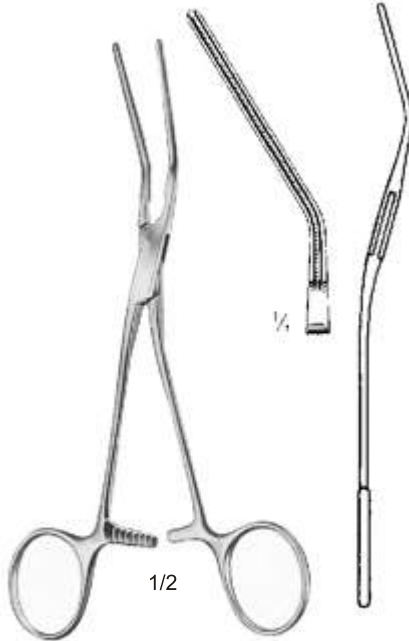

**DE BAKEY
6045**
160mm (6")



**DE BAKEY
6046**
150mm (6")

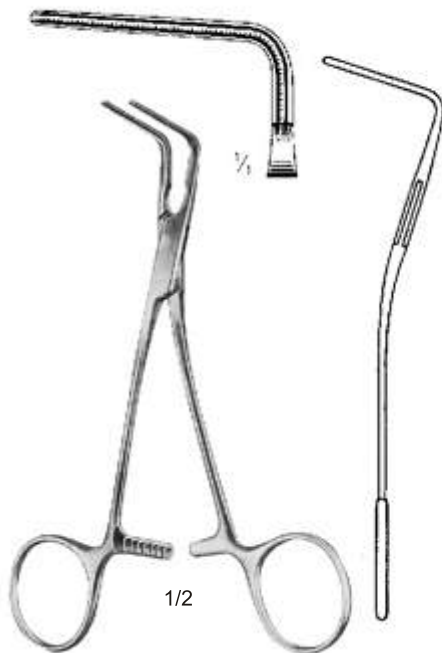

**DE BAKEY
6047**
150mm (6")



**DE BAKEY
6048**
170mm (6.1/4")

ATRAUMA CARDIOVASCULAR FORCEPS

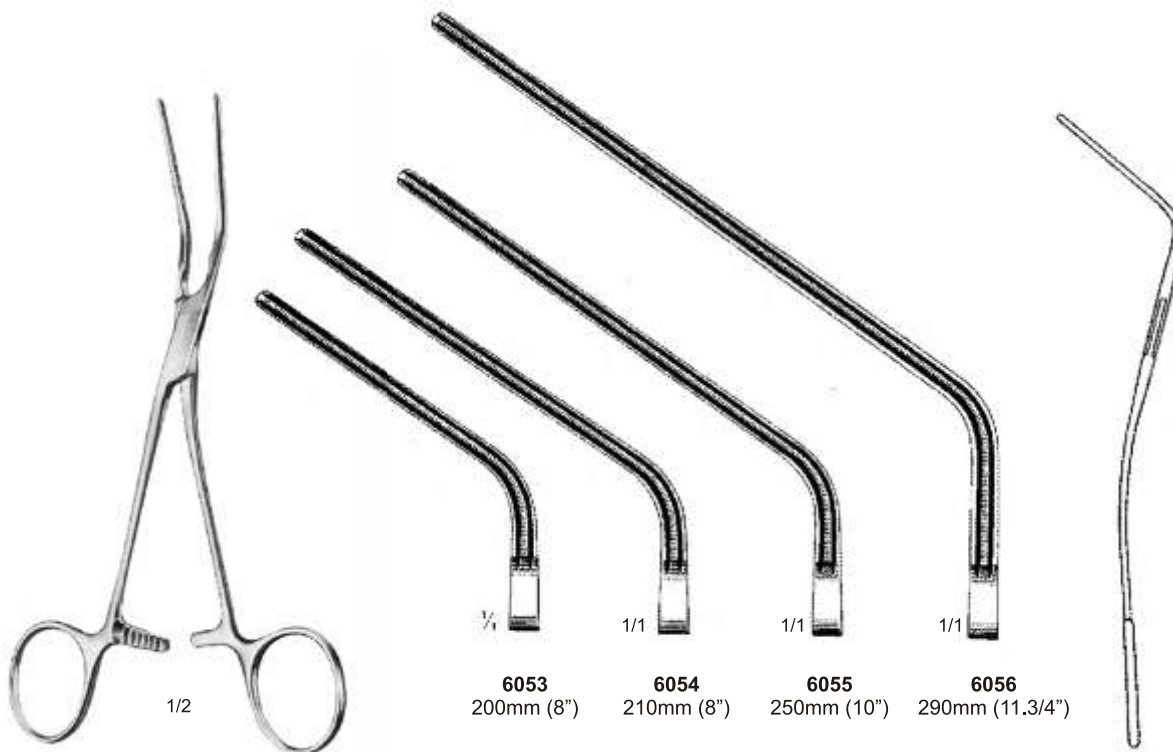
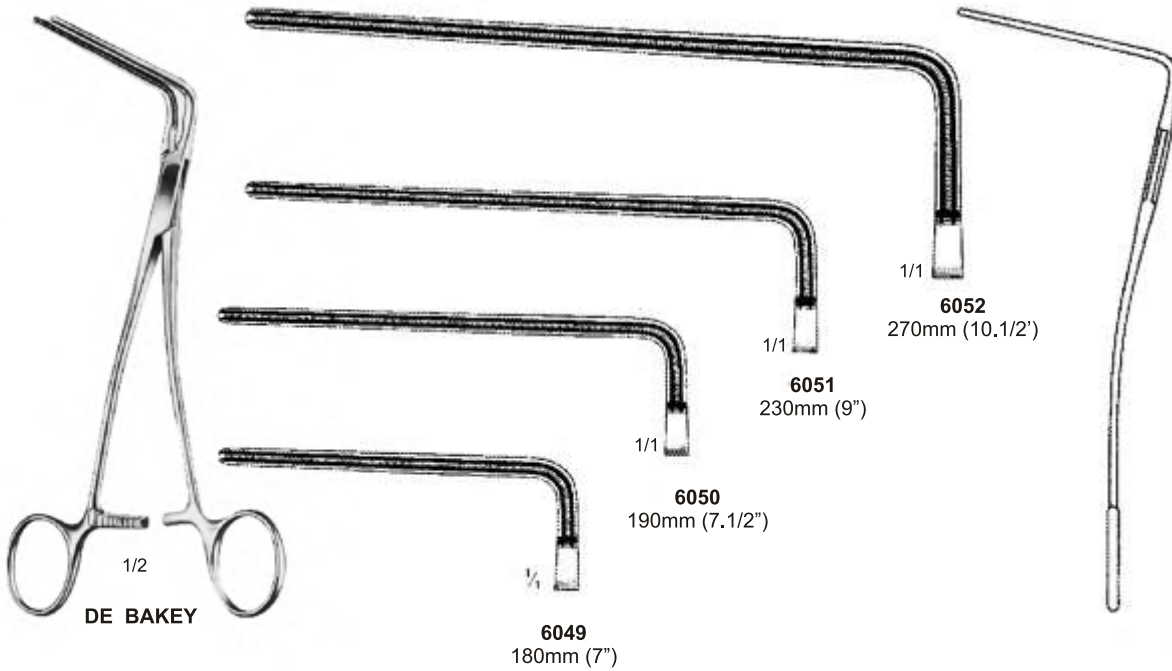



6057
240mm (9.1/2")



6058
240mm (9.1/2")



6059
240mm (9.1/2")



6060
240mm (9.1/2")

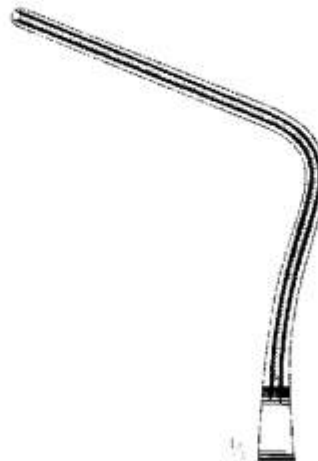

ATRAUMA CARDIOVASCULAR FORCEPS

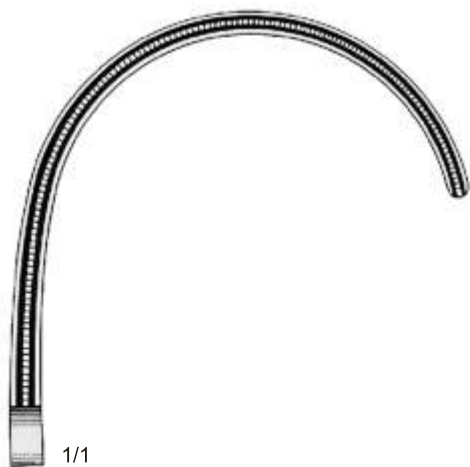

**WEBER
6061**
260mm (10.1/4")
Left



**WEBER
6062**
260mm (10.1/4")
Right

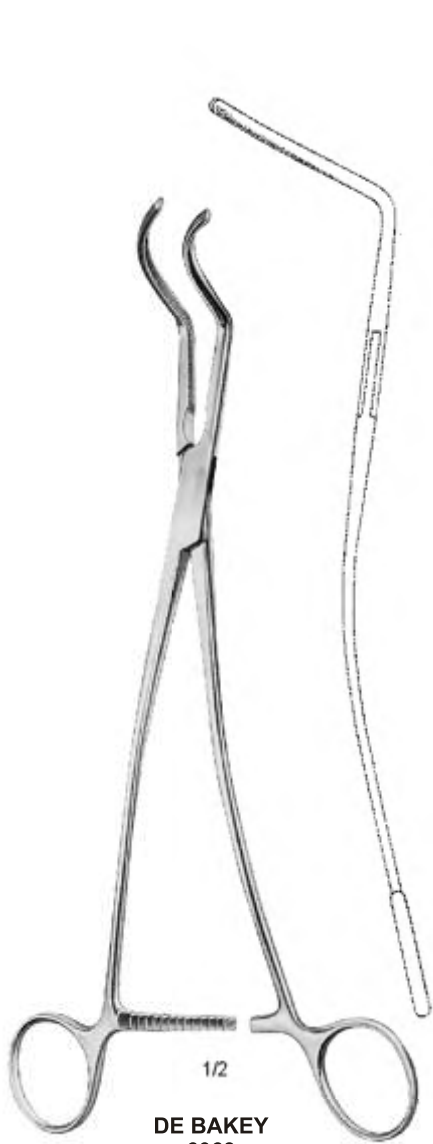

1/2
DE BAKEY
6063
27cm (10.1/2")

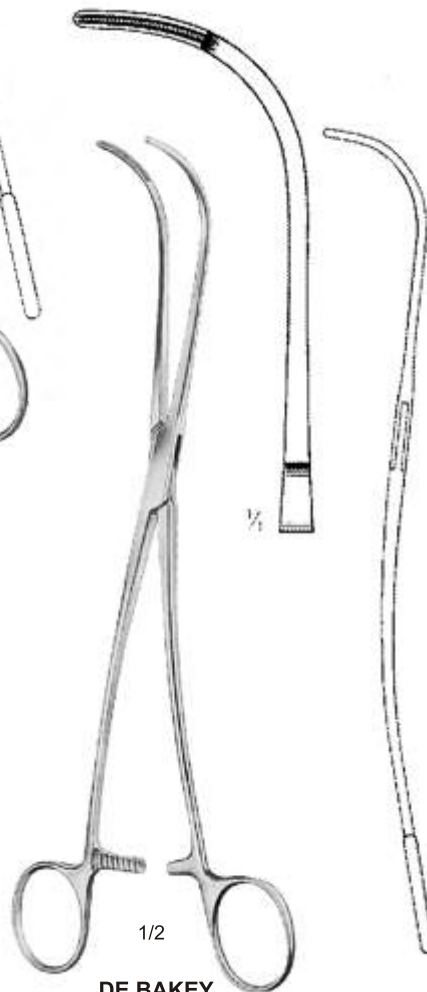
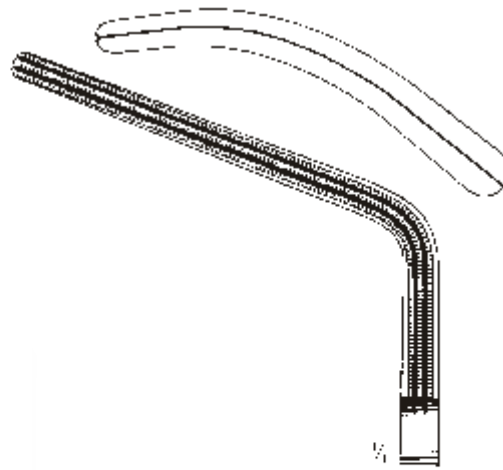

1/2
DE BAKEY
6064
240mm (9.1/2")

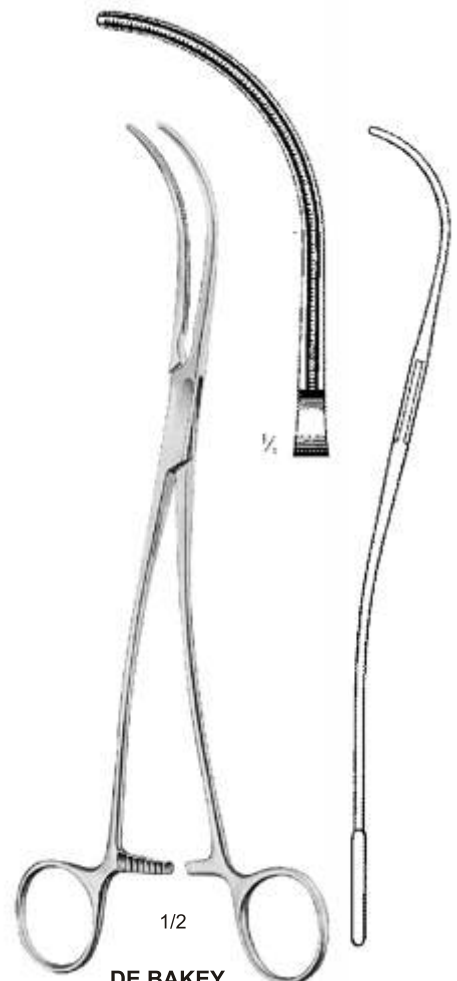

1/2
DE BAKEY
6065
240mm (9.1/2")

ATRAUMA CARDIOVASCULAR FORCEPS



DE BAKEY
6066
160mm (6.1/4")

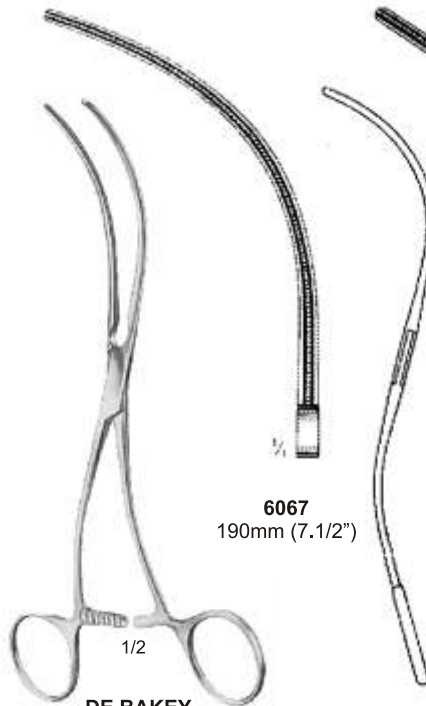

6067
190mm (7.1/2")

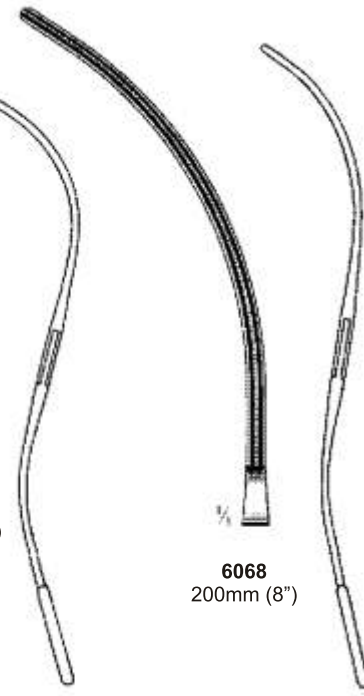

6068
200mm (8")

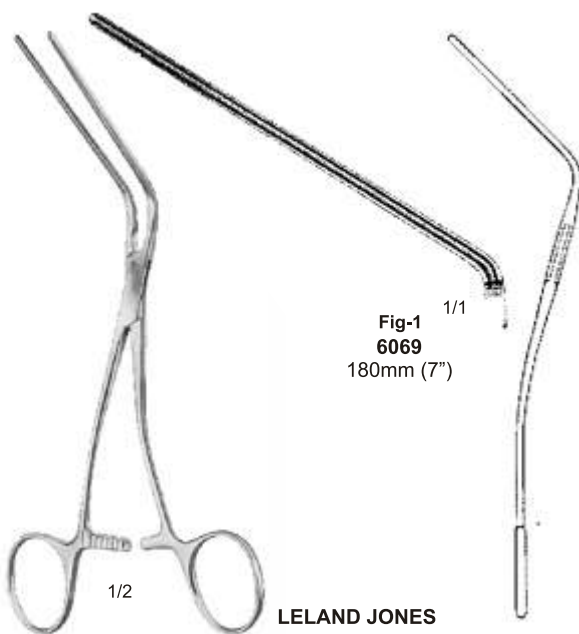

Fig-1
6069
180mm (7")



Fig-2
6070
190mm (7.1/2")



Fig-3
6071
200mm (8")



ATRAUMA BULLDOG CLAMPS



1/1

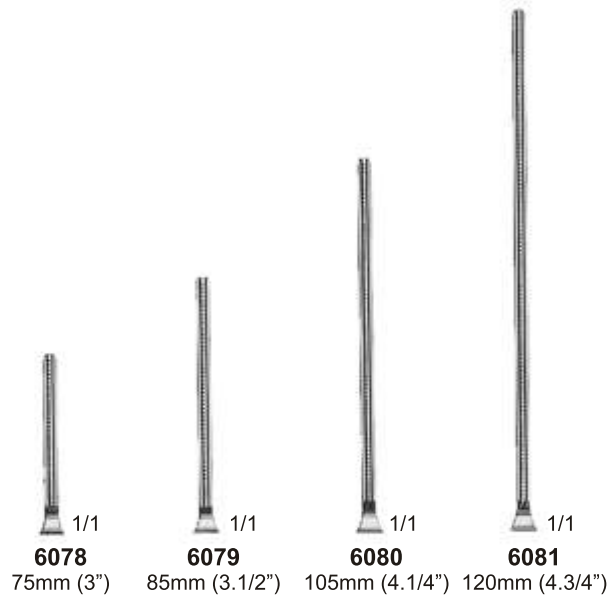

6078 1/1 75mm (3")
6079 1/1 85mm (3.1/2")
6080 1/1 105mm (4.1/4")
6081 1/1 120mm (4.3/4")

DEBAKEY BULLDOG CLAMPS



1/1

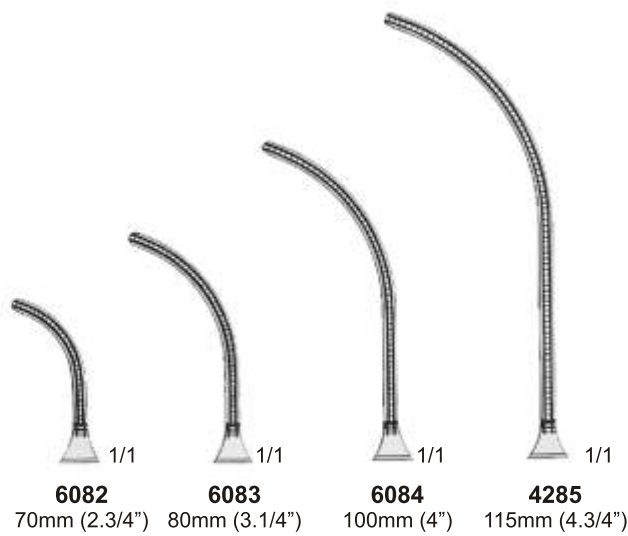

6082 1/1 70mm (2.3/4")
6083 1/1 80mm (3.1/4")
6084 1/1 100mm (4")
4285 1/1 115mm (4.3/4")

DEBAKEY BULLDOG CLAMPS

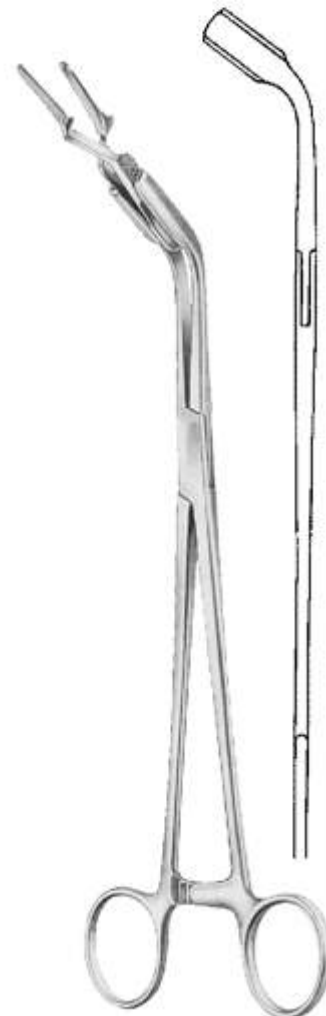

APPLYING FORCEPS
6086
 230mm (9")

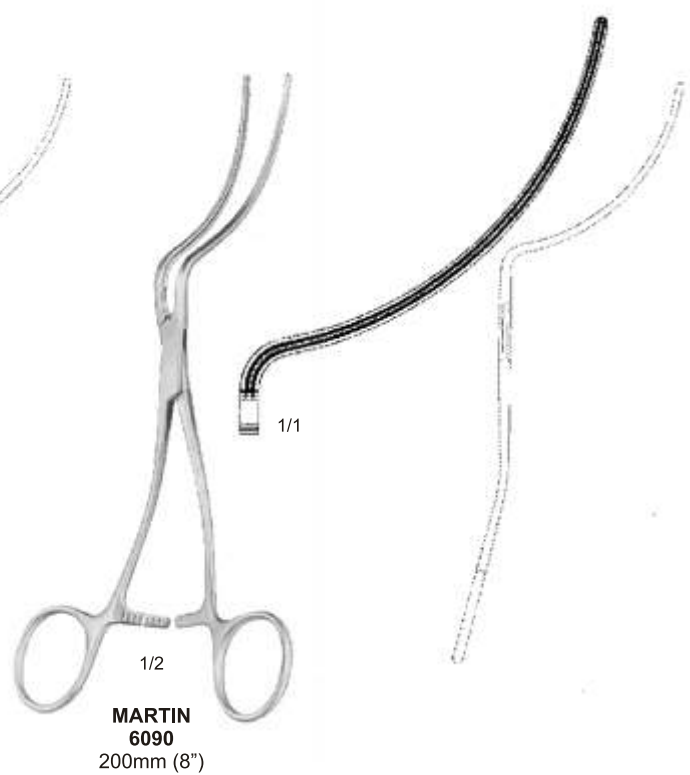
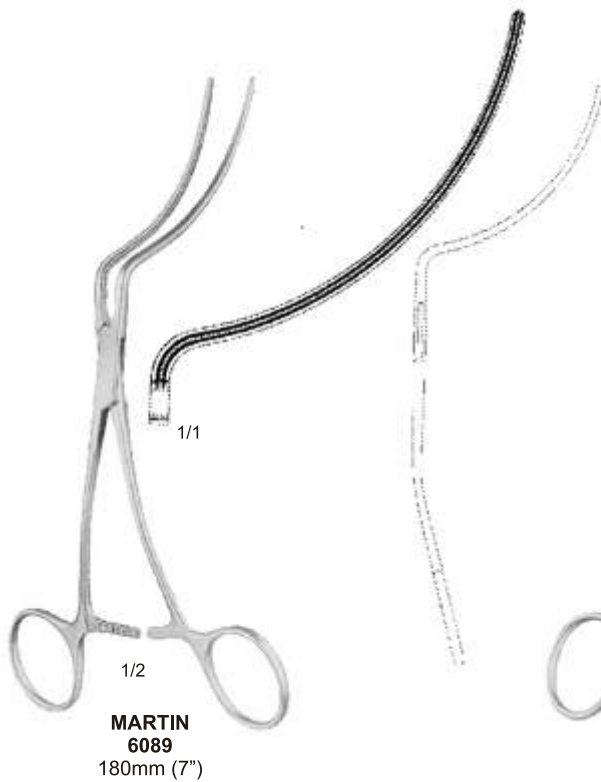
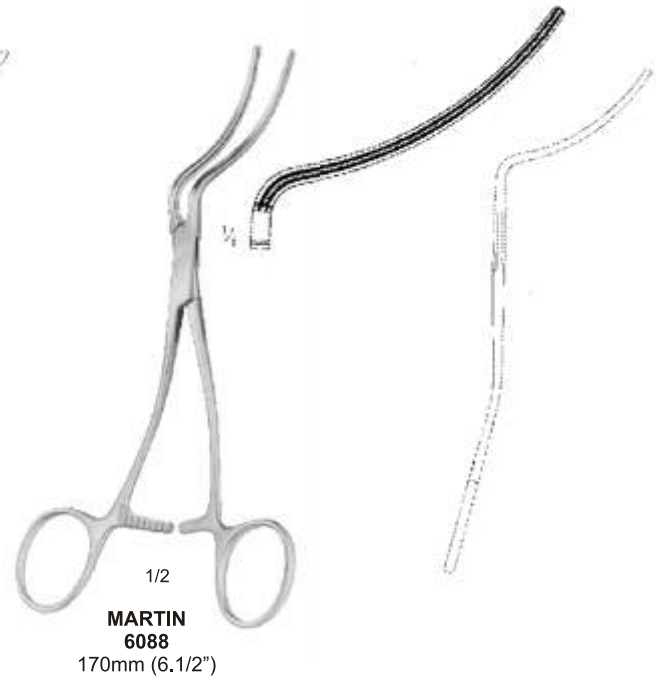
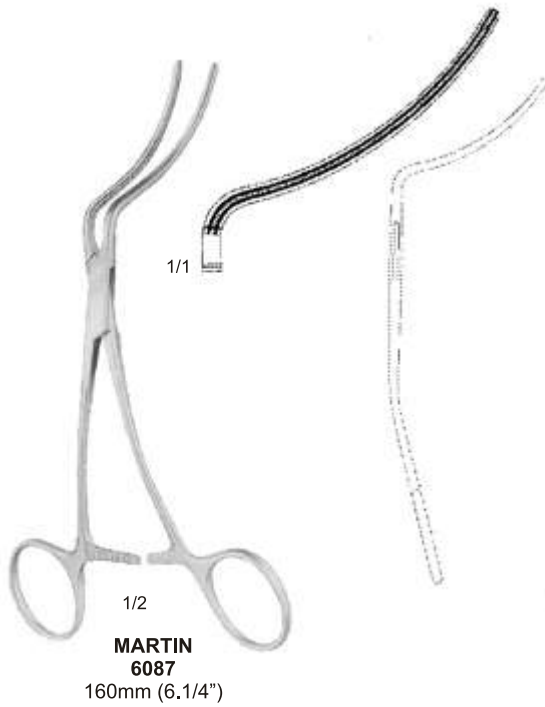

A

AUFRICHT (SCISSORS)	19
AMERICAN PATTERN UMBILICAL (SCISSORS)	19
ALLIS (TC DISSECTING FORCEPS)	38
ADSON (TC DISSECTING FORCEPS)	40
ARTHURE (SPLINTER FORCEPS)	45
ADSON (TOOTHED DISSECTING FORCEPS)	47
ADSON-BROWN (TOOTHED DISSECTING FORCEPS)	47
ALLIS (TISSUE FORCEPS)	59
AMERICAN PATTERN ALLIS (TISSUE FORCEPS)	59
ARRUGA (MICRO NEEDLE HOLDERS)	80
ANEL LACHRYMAL (PROBES)	91
ADSON SELF RETAINING RETRACTORS)	96
ALLISON (HAND HELD RETRACTORS)	104
ABDOMINAL RETRACTOR (HAND HELD RETRACTORS)	108
AUVARD (VAGINAL RETRACTOR/UTERINE DILATORS)	130
AMNIOTOME (UTERINE CANNULAE)	149
ADSON (RASPIRIES)	161
AMPUTATION SAW (AMPUTATION INSTRUMENTS)	165
ARMY REGULATION (AMPUTATION INSTRUMENTS)	165
ADSON FRAZIER (SUCTION TUBES)	167
ADSON (SUCTION TUBES)	167
APPLYING FORCEPS (ATRAUMA BULLDOG CLAMPS)	195

B

BARRON (SURGICAL HANDLES)	12
BRAUN STADTLER EPISIOTOMY (SCISSORS)	19
BABY METZENBAUM (TC SCISSORS)	26
BABY METZENBAUM (TC SCISSORS)	34
BABCOCK (TC DISSECTING FORCEPS)	38
BABY - ADSON (DISSECTING & LIGATURE FORCEPS)	44
BONNEY (TOOTHED DISSECTING FORCEPS)	46
BICKFORD (TOOTHED DISSECTING FORCEPS)	46
BONNEY (SERRATED DISSECTING FORCEPS)	53
BICKFORD (SERRATED DISSECTING FORCEPS)	53
BABY-CRILE (HAEMOSTATS FORCEPS)	65,66
BOZEMANN (DRESSING FORCEPS)	67
BALL AND SOCKET (TOWEL CLAMPS)	69
BACKHAUS (TOWEL CLAMPS)	69
BARRAQUER (MICRO NEEDLE HOLDERS)	80
BABY-CRILE-WOOD (TC NEEDLE HOLDERS)	87
BAUMGARTNER (TC NEEDLE HOLDERS)	87
BRODIE (PROBES)	92
BECKMANN-ADSON SELF RETAINING RETRACTORS)	96
BERKELEY ABDOMINAL (SELF RETAINING RETRACTORS)	101
BALLANCE (HAND HELD RETRACTORS)	110
BLAKE (CHOLECYSTECTOMY AND GALL STONE FORCEPS)	125
BLADDER SPATULA (UROLOGY)	139
BARRON (PROCTOLOGY HAEMORRHOIDAL LGATORS)	141
BARNES (UTERINE CANNULAE)	149
BURKE (CERVICAL BIOPSY FORCEPS)	152
BONNEY POLYPI (OVUM FORCEPS)	153
BOYD BONE CURETTE (RASPIRIES)	159
BRISTOW (RASPIRIES)	160
BLAKE (AMPUTATION INSTRUMENTS)	166
BARRON (SUCTION TUBES)	168
BELUCCI (SUCTION TUBES)	168
BELUCCI SUCTION TUBE (SUCTION TUBES)	168
BURFORD (RIB SPREADERS)	173
BECK RONGEUR (DISC RONGEURS)	178
BEYER (BONE RONGEURS)	181

C

COBBETT (SKIN GRAFTING KNIVES)	14
CRAFOORD (SCISSORS)	18
COUNTER SCISSORS (SCISSORS)	23
CUSHING (TC DISSECTING FORCEPS)	40
CUSHING (TC DISSECTING FORCEPS)	37
CANADIAN (TOOTHED DISSECTING FORCEPS)	46
CAIRNS (DOTT) (DELICATE DISSECTING FORCEPS)	50
CANADIAN (SERRATED DISSECTING FORCEPS)	55
CHAPUT (POIRIER) (TISSUE FORCEPS)	57,58
CAIRNS (HAEMOSTATS FORCEPS)	64
CRAFOORD (HAEMOSTATS FORCEPS)	64
CRILE (HAEMOSTATS FORCEPS)	64
COLLIN TONGUE FORCEPS (TONGUE DEPRESSORS)	70
CRILE WOOD (NEEDLE HOLDERS)	77
CRILE MURRAY (NEEDLE HOLDERS)	77
CONVERSE (NEEDLE HOLDERS)	78
CASTROVIEJO (MICRO NEEDLE HOLDERS)	80
COMBINED SCISSOR (TC NEEDLE HOLDERS)	82
CRILE - WOOD (TC NEEDLE HOLDERS)	86
CONVERSE (TC NEEDLE HOLDERS)	87
CRILE - WOOD (TC NEEDLE HOLDERS)	87
COARSE (TC NEEDLE HOLDERS)	88
CASTROVIEJO (TC NEEDLE HOLDERS)	88
CHARNLEY (SELF RETAINING RETRACTORS)	94
CHARNLEY PIN (SELF RETAINING RETRACTORS)	94

CONE (SELF RETAINING RETRACTORS)	97
CZERNY (HAND HELD RETRACTORS)	110
CUSHINGS VEIN (HAND HELD RETRACTORS)	114
CUSSO (VAGINAL SPECULUM)	133
CUSCO SPECULAM (VAGINAL SPECULUM)	133
CLUTTON URETHRAL SOUNDS (UROLOGY)	135
CUNNINGHAM PENILE CLAMPS (UROLOGY)	138
CZERNY RECTAL SPECULUM (PROCTOLOGY)	145
CERVICAL BIOPSY FORCEPS	150
CAPENER CHISELS (OSTEOTOMES, CHISELS & GOUGES)	157
COLLIER AND MORRIS (BONE SCOOPS)	158
CAIRNS SKULL FLAP (BONE LEVERS & ELEVATORS)	164
CONE SUCTION TUBES (SUCTION TUBES)	167
COOLEY (RIB SPREADERS)	174
CUSHING (CAIRNS) RONGEUR (DISC RONGEURS)	178
CUSHING RONGEURS (DISC RONGEURS)	178
CAIRNS (BONE RONGEURS)	181
COOLEY (VASCULAR DILATORS)	184
COOLEY (DILATORS)	185
COOLEY (ATRAUMA CARDIOVASCULAR FORCEPS)	186

D

DIAGNOSTICS SET	01-09
DRESSING (SCISSORS)	17
DOYEN ABDOMINAL (SCISSORS)	23
DELICATE SCISSORS (TC SCISSORS)	26
DEBAKEY (TC SCISSORS)	35
DRESSING SCISSORS (TC SCISSORS)	35
DEBAKEY (TC DISSECTING FORCEPS)	37
DUVAL (TISSUE FORCEPS)	41
DENIS BROWNE (SPLINTER FORCEPS)	45
DISSECTING FORCEPS (TOOTHED DISSECTING FORCEPS)	48
DISSECTING FORCEPS (TOOTHED DISSECTING FORCEPS)	49
DISSECTING (SERRATED DISSECTING FORCEPS)	54
DISSECTING FORCEPS 55 (SERRATED DISSECTING FORCEPS)	55
DUNHILL (HAEMOSTATS FORCEPS)	61
DERF (NEEDLE HOLDERS)	78
DEBAKEY (TC NEEDLE HOLDERS)	82
DERF (TC NEEDLE HOLDERS)	86
DIRECTORS (PROBES)	92
DURHAM (HAND HELD RETRACTORS)	113
DEAVER (HAND HELD RETRACTORS)	117,118,119
DEAVER GRIP (HAND HELD RETRACTORS)	118,119
DEAVER (HAND HELD RETRACTORS)	118,119,120
DOYEN (INTESTINAL CLAMPS)	123,124
DOYEN (KOCHER) (INTESTINAL CLAMPS)	124
DOYEN (MAYO ROBSON) (INTESTINAL CLAMPS)	124
DUCT DISSECTING (CHOLECYSTECTOMY)	125
DESJARDINS (GALL DUCT PROBES)	126
DOYEN (VAGINAL SPECULUM)	132
DOYEN (OVUM FORCEPS)	153
DALE (ATRAUMA CARDIOVASCULAR FORCEPS)	170
DE-BAKEY SATINSKY (ATRAUMA BULLDOG CLAMPS)	171
DE BAKEY-CAROTIS (ATRAUMA BULLDOG CLAMPS)	171
DE BAKEY SATINSKY (ATRAUMA BULLDOG CLAMPS)	171
DE BAKEY (VASCULAR DILATORS)	184
DE BAKEY (ATRAUMA CARDIOVASCULAR FORCEPS)	187,188,189
DE BAKEY (ATRAUMA CARDIOVASCULAR FORCEPS)	192
DE BAKEY (ATRAUMA CARDIOVASCULAR FORCEPS)	193
DEBAKEY BULLDOG CLAMPS (ATRAUMA BULLDOG CLAMPS)	195

E

ERGONOMIC (SURGICAL HANDLES)	10
EXTRA FINE (DELICATE DISSECTING FORCEPS)	50

F

FAVALORO (ORAL SCISSORS)	22
FINE CURVED (DISSECTING & LIGATURE FORCEPS)	43
FEILCHENFEL (SPLINTER FORCEPS)	45
FINE (TOOTHED DISSECTING FORCEPS)	46
FORCEPS (SERRATED DISSECTING FORCEPS)	54
FRASER-KELLY (CRILE) (HAEMOSTATS FORCEPS)	61
FRASER - ADSON (HAEMOSTATS FORCEPS)	61
FORESTER (SPONGE HOLDING FORCEPS)	68
FLAT TONGUE DEPRESSOR (TONGUE DEPRESSORS)	71
FINE (TC NEEDLE HOLDERS)	88
FINSON (SELF RETAINING RETRACTORS)	98
FEMALE CATHETERS (UROLOGY)	135
FAURE (PERITONEUM INSTRUMENTS)	147
FRENCH MODEL PELVIMETER (UTERINE CANNULAE)	149
FREER ELEVATOR (RASPIRIES)	161
FINGER SAW (AMPUTATION INSTRUMENTS)	165
FRAZIER (SUCTION TUBES)	167
FORMBY (SUCTION TUBES)	168

G

GILLIES (TOOTHED DISSECTING FORCEPS)	48
GILLIES (NEEDLE HOLDERS)	76
GILLIES (TC NEEDLE HOLDERS)	82
GWYNNE EVANS TONSIL (DISSECTORS)	89
GELPI VULVA (SELF RETAINING RETRACTORS)	98
GOLIGHER (SELF RETAINING RETRACTORS)	101
GOSSET (Rereactor)	102
GEARY GRANT (CHOLECYSTECTOMY & GALL STONE)	128
GRAVE (VAGINAL SPECULUM)	134
GABRIEL METAL (HAEMORRHOIDAL SYRINGES)	140
GABRIEL NEEDLES (HAEMORRHOIDAL SYRINGES)	140
GABRIEL SYRINGES (HAEMORRHOIDAL SYRINGES)	140
GABRIEL METAL AND GLASS SYRINGE SET (HAEMORRHOIDAL SYRINGES)	140
GRAEME ANDERSON RECTAL SPECULUM (PROCTOLOGY)	144
GABRIEL RECTAL SPECULUM (PROCTOLOGY)	144
GWILLIAM HYSTERECTOMY (HYSTERECTOMY CLAMPS)	146
GREGORY (ATRAUMA CARDIOVASCULAR FORCEPS)	169
GLOVER (ATRAUMA BULLDOG CLAMPS)	171
GREGORY-SOFT (ATRAUMA BULLDOG CLAMPS)	171
GLUCK (BONE & RIB SHEARS)	175

H

HEYMANN TURBINECTOMY (ORAL, DELICATE SCISSORS)	21
HEDGEMAN (DIETRICH) (ORAL SCISSORS)	22
HYSTERECTOMY SCISSORS (TC SCISSORS)	29
HYSTERECTOMY (TC SCISSORS)	29
HUNTER (SPLINTER FORCEPS)	45
HALSTEAD MOSQUITO (HAEMOSTATS FORCEPS)	65,66
HEYWOOD-SMITH TONGUE FORCEPS (TONGUE DEPRESSORS)	70
HALSEY (NEEDLE HOLDERS)	73
HEGAR (NEEDLE HOLDERS)	74
HEANEY (NEEDLE HOLDERS)	76
HAGAR-MAYO (TC NEEDLE HOLDERS)	81
HAGER-OSLEN (TC NEEDLE HOLDERS)	82
HOESEL (TC NEEDLE HOLDERS)	83
HALSEY (TC NEEDLE HOLDERS)	86
HALSEY (TC NEEDLE HOLDERS)	87
HENDERSON (SELF RETAINING RETRACTORS)	97
HARRINGTON - PEMBERTON (HAND HELD RETRACTORS)	104
HAWKIN AMBLER (VAGINAL RETRACTOR/UTERINE DILATORS)	130
HEGAR (VAGINAL RETRACTOR/UTERINE DILATORS)	130
HEYWOOD SMITH (OVUM FORCEPS)	154
HEATH (MALLETS)	156
HOHMANN (BONE LEVERS)	163
HANDLE (SUCTION TUBES)	167
HOUSE (SUCTION TUBES)	168
HEANLEY (BONE RONGEURS)	179
HARKEN (ATRAUMA CARDIOVASCULAR FORCEPS)	190

I

IRIS (DELICATE SCISSORS)	20
IRIS SCISSORS (TC SCISSORS)	25
IRIS DELICATE (TC SCISSORS)	35
I.M.A Retractor (SELF RETAINING RETRACTORS)	94
IRWIN (SELF RETAINING RETRACTORS)	101
ISRAEL (HAND HELD RETRACTORS)	109
I.U.D. REMOVING HOOK (OBSTETRICS INSTRUMENTS)	148

J

JEFFERSON (TOOTHED DISSECTING FORCEPS)	47
JEFFERSON (DELICATE DISSECTING FORCEPS)	50
JUD-ALLIS (TISSUE FORCEPS)	57, 58
JAMESON (NEEDLE HOLDERS)	76
JULIAN (TC NEEDLE HOLDERS)	85
JOBSON HORNE (PROBES)	91
JANSON (SHEA) (SELF RETAINING RETRACTORS)	97
JEFFERSON (SELF RETAINING RETRACTORS)	97
JACKSON - BURROWS (SELF RETAINING RETRACTORS)	98
JOLL THYROID (SELF RETAINING RETRACTORS)	99
JOSEPH (RASPATORIES)	161
JAVID (ATRAUMA CARDIOVASCULAR FORCEPS)	169
JANSEN-MIDDLETON SEPTUM FORCEPS (BONE RONGEURS)	181

K

KILNER (SCISSORS)	19
KOCHER (HAEMOSTATS FORCEPS)	62
KELLY (HAEMOSTATS FORCEPS)	63
KOCHER (HAEMOSTATS FORCEPS)	63
KELLY HALSTEAD (HAEMOSTATS FORCEPS)	63
KILNER (NEEDLE HOLDERS)	76
KILNER (TC NEEDLE HOLDERS)	81
KOCHER THYROID (DISSECTORS)	90
KIRSCHNER RETRACTOR SET (Rereactor)	102
KOCHER BONE HOOK (HAND HELD RETRACTORS)	106
KOCHER (HAND HELD RETRACTORS)	114
KOCHER (HAND HELD RETRACTORS)	116
KRISTELLE (VAGINAL SPECULUM)	131
KOGAN ENDOCERVICAL SPECULUM (VAGINAL SPECULUM)	132
KELLY PROCTOSCOPE (PROCTOLOGY)	144
KIELLAND (OBSTETRICS INSTRUMENTS)	148
KEVORKIAN (CERVICAL BIOPSY FORCEPS)	151
KEVORKIAN (CERVICAL BIOPSY FORCEPS)	152
KELSEY FRY (MALLETS)	156
KILLEARN (BONE RONGEURS)	179

L

LLOYD DAVIS RECTAL (SCISSORS)	18
LISTER BANDAGE (SCISSORS)	24
LEXER (TC SCISSORS)	29
LEXER (TC SCISSORS)	32
LUCAE (TC DISSECTING FORCEPS)	37
LANE (TISSUE FORCEPS)	42
LIGATURE FORCEPS (DISSECTING & LIGATURE FORCEPS)	44
LANE (TOOTHED DISSECTING FORCEPS)	49
LITTLEWOOD (TISSUE FORCEPS)	56
LITTLEWOOD (TISSUE FORCEPS)	57
LLOYD DAVIS (HAEMOSTATS FORCEPS)	62
LACK TONGUE DEPRESSOR (TONGUE DEPRESSORS)	71
LAWRANCE (NEEDLE HOLDERS)	72
LITTLEWOOD (TISSUE FORCEPS)	79
LIEBRICH LACHRYMAL (PROBES)	91
LANGENBECK BONE HOOK (HAND HELD RETRACTORS)	106
LEMPERT (HAND HELD RETRACTORS)	110
LANGENBECK (HAND HELD RETRACTORS)	115
LANE TWIN ANASTOMOSIS (INTESTINAL CLAMPS)	121
LLOYD DAVIS RECTAL OCCLUSION (INTESTINAL CLAMPS)	122
LOWER (CHOLECYSTECTOMY & GALL STONE)	128
LAHEY (CHOLECYSTECTOMY & GALL STONE)	128
LLOYD DAVIES (SIGMOIDOSCOPY / BIOPSY)	142
LLOYD DAVIES (SIGMOIDOSCOPY)	143
LUCAE (MALLETS)	156
LEMPERT (BONE SCOOPS)	158
LANGENBECK (RASPATORIES)	160
LAMBOTE (RASPATORIES)	160
LANE BONE LEVER (BONE LEVERS & ELEVATORS)	164
LISTON (AMPUTATION INSTRUMENTS)	166
LANGENBECK (AMPUTATION INSTRUMENTS)	166
LEKSELL (BONE RONGEURS)	179
LUER (BONE RONGEURS)	181
LEWIN (BONE HOLDING FORCEPS)	182
LELAND JONES (ATRAUMA CARDIOVASCULAR FORCEPS)	193

M

MAYO (SCISSORS)	15
MAYO HARRINGTON (SCISSORS)	16
MAYO (STILLE) (SCISSORS)	16
METZENBAUM (SCISSORS)	17
METZENBAUM (Nelson) (SCISSORS)	17
MCINDOE SCISSORS (SCISSORS)	24
MAYO DISSECTING SCISSORS (TC SCISSORS)	26
METZENBAUM (TC SCISSORS)	27
MAYO-LEXER (TC SCISSORS)	29
METZENBAUM (TC SCISSORS)	30,31
MCINDOE SCISSORS (TC SCISSORS)	31
MAYO - LEXER (TC SCISSORS)	32
METZENBAUM (TC SCISSORS)	33
MAYO (TC SCISSORS)	34
METZENBAUM DELICATE (TC SCISSORS)	34
METZENBAUM (TC SCISSORS)	34
METZENBAUM (TC SCISSORS)	36
MAYO (TC SCISSORS)	36
Mcindoe (TC SCISSORS)	36
MERIAM (TC DISSECTING FORCEPS)	37
MICRO ADSON (DISSECTING & LIGATURE FORCEPS)	44
MICRO SOFT TOUCH RING TIP (SPLINTER FORCEPS)	45
MICINDOE (TOOTHED DISSECTING FORCEPS)	48
MACINDOE (DELICATE DISSECTING FORCEPS)	51

M

MAINGOT INTESTINAL (SERRATED DISSECTING FORCEPS)
 MAYO (HAEMOSTATS FORCEPS)
 MAYO (TOWEL CLAMPS)
 MOYNIHAN (TOWEL CLAMPS)
 MAYO (NEEDLE HOLDERS)
 MCPHAILS (NEEDLE HOLDERS)
 MATHIEUNEEDLE HOLDERS)
 MAYO (BAUMGARTNER) (NEEDLE HOLDERS)
 MAYO (MASSON) (NEEDLE HOLDERS)
 MAYO (NEEDLE HOLDERS)
 MAYO (DUNHILL) (NEEDLE HOLDERS)
 MAYO (NEEDLE HOLDERS)
 MATHIEU-STANDARD (TC NEEDLE HOLDERS)
 MATHIEU (TC NEEDLE HOLDERS)
 MASING (TC NEEDLE HOLDERS)
 MICRO (TC NEEDLE HOLDERS)
 MACDONALD (DISSECTORS)
 MOLLISON (SELF RETAINING RETRACTORS)
 MILLIN RETROPUBIC (SELF RETAINING RETRACTORS)
 MOYNIHAN (GALL DUCT PROBES)
 MIXSTER (CHOLECYSTECTOMY & GALL STONE)
 MOYNIHAN (CHOLECYSTECTOMY & GALL STONE)
 MOUAT GALL BLADDER LIFTING FORCEPS (CHOLECYSTECTOMY & GALL STONE)
 MODIFIED DOYEN (VAGINAL SPECULUM)
 MODIFIED WERTHEIM (VAGINAL SPECULUM)
 MATHIEU (VAGINAL SPECULUM)
 McGEE LATERAL VIGNAL RETRACTOR (VAGINAL SPECULUM)
 MOULDED RUBBER SHEATHS (UROLOGY)
 MILLIN (UROLOGY)
 MCEVEDY RECTAL SPECULUM WITH BATTERY HANDLE (PROCTOLOGY)
 MIKULICZ (PERITONEUM INSTRUMENTS)
 MCLINTOCK (OVUM FORCEPS)
 MARTINI (BONE SCOOPS)
 MCKISSOCK (RASPATORIES)
 MERCEDES (RIB SPREADERS)
 MARTIN((ATRAUMA BULLDOG CLAMPS)

N

NELSON - METZENBAUM (TC SCISSORS)
 NELSON-METZENBAUM (TC SCISSORS)
 NELSON-METZENBAUM (TC SCISSORS)
 NAUNTON MORGAN (NEEDLE HOLDERS)
 NEEDLE HOLDER (TC NEEDLE HOLDERS)
 NESTED TROCARS (TROCARS)
 NORFOLK AND NORWICH (SELF RETAINING RETRACTORS)
 NAUNTON MORGAN RECTAL SPECULUM (PROCTOLOGY)
 NOTO (OVUM FORCEPS)

O

OLSEN HEGAR (NEEDLE HOLDERS)
 OSCHNER GALL BLADDER (TROCARS)
 OCHSNER (GALL DUCT PROBES)
 OFFICER BIOPSY FORCEPS (SIGMOIDOSCOPY / BIOSPY)
 OLIVECRONA (BONE RONGEURS)

P

POTTS (ORAL SCISSORS)
 POTTS-NEVINS (TC DISSECTING FORCEPS)
 PENNYBACKER (TOOTHED DISSECTING FORCEPS)
 PAYR (DISSECTORS)
 PLESTER-JANSEN (SELF RETAINING RETRACTORS)
 PLESTER-JANSEN (SELF RETAINING RETRACTORS)
 PLESTER-JANSEN (SELF RETAINING RETRACTORS)
 POZZI ABDOMINAL SELF RETAINING RETRACTORS
 PEDERSON (VAGINAL SPECULUM)
 PENILE CLAMP (UROLOGY)
 PARK ANAL (PROCTOLOGY HAEMORRHOIDAL IGATORS)
 PRATT RECTAL SPECULUM (PROCTOLOGY)
 PEROTONEUM (PERITONEUM INSTRUMENTS)
 PENNYBACKER (RASPATORIES)
 PERCY AMPUTATION FLAP (AMPUTATION INSTRUMENTS)
 PLASTER SHEARS (PLASTER CAST REMOVAL INSTRUMENTS)
 PENNYBACKER (BONE RONGEURS)
 POTTS (ATRAUMA CARDIOVASCULAR FORCEPS)

R

REYNOLDS SCISSORS (TC SCISSORS)
 REYNOLDS (SCISSORS)
 RUTHERFORD MORISON (TISSUE FORCEPS)
 RAMSEY (TOOTHED DISSECTING FORCEPS)
 RAMSEY (SERRATED DISSECTING FORCEPS)
 RAMPLEY (SPONGE HOLDING FORCEPS)
 RNTNE HOSPITAL (SELF RETAINING RETRACTORS)
 RETRACTOR (RETRACTOR)
 RICHARDSON (HAND HELD RETRACTORS)
 RESANO (INTESTINAL CLAMPS)
 RANDALL (UROLOGY)
 RUSKIN - LISTON (BONE CUTTING FORCEPS)
 RUSKIN (BONE RONGEURS)

S

SURGICAL HANDLES
 STERILE BLADES
 SILVER (SKIN GRAFTING KNIVES)
 STRABISMUS (DELICATE SCISSORS)
 SCHUKNECHT WIRE CUTTING (ORAL, DELICATE SCISSORS)
 STEVENS TENOTOMY (ORAL, DELICATE SCISSORS)
 SCHUMACHER UMBILICAL (SCISSORS)
 SURGICAL SCISSORS (TC SCISSORS)
 STRABISMUS SCISSORS (TC SCISSORS)
 SIMS (TC SCISSORS)
 SCISSORS (TC SCISSORS)
 SIMS (TC SCISSORS)
 SEMKEN (TC DISSECTING FORCEPS)
 STILES (ALLIS-THOMS) (TISSUE FORCEPS)
 S.SHAPED DELICATE (DISSECTING & LIGATURE FORCEPS)
 SILCOCK (TOOTHED DISSECTING FORCEPS)
 SILCOCK (DELICATE DISECTING FORCEPS)
 ST MARKS (SERRATED DISSECTING FORCEPS)
 SPENCER WELLS (HAEMOSTATS FORCEPS)
 SAROT (TC NEEDLE HOLDERS)
 STANDARD (TC NEEDLE HOLDERS)
 SUPRAPUBIC (TROCARS)
 ST MARKS HOSPITAL PERINEAL (SELF RETAINING RETRACTORS)
 SMILLIE RETRACTORS (HAND HELD RETRACTORS)
 SIMON (VAGINAL SPECULUM)
 SIMS (VAGINAL SPECULUM)
 SIMS RECTAL SPECULUM (PROCTOLOGY)
 SCHUMARCHER (CERVICAL BIOPSY FORCEPS)
 SPARE DISKS (MALLETS)
 SWEDISH MODEL CHISELS (OSTEOTOMES, CHISELS & GOUGES)
 SWEDISH MODEL OSTEOTOME (OSTEOTOMES, CHISELS & GOUGES)
 SMITH-PETERSON OSTEOTOME (OSTEOTOMES, CHISELS & GOUGES)
 ST THOMAS (BONE LEVERS & ELEVATORS)
 SUCTION TUBES (SUCTION TUBES)
 SANTULLI(ATRAUMA BULLDOG CLAMPS)
 STILLE (BONE & RIB SHEARS)
 STILLE LISTON (BONE CUTTING FORCEPS)
 SARGENT (VAN HAVRE) (BONE RONGEURS)
 STILLE-RUSKIN (BONE RONGEURS)

T

TOENNIS ADSON (TC SCISSORS)
 TROELTSCH (Wilde) (SPLINTER FORCEPS)
 TUDICHUM (SPLINTER FORCEPS)
 TREVES (TOOTHED DISSECTING FORCEPS)
 TUBING CLAMP (TISSUE FORCEPS)
 TUBING CLAMP (TISSUE FORCEPS)
 TOENNIS (TC NEEDLE HOLDERS)
 TRAVERS (SELF RETAINING RETRACTORS)
 TURNER WARWICK (SELF RETAINING RETRACTORS)
 TRAVERS (SELF RETAINING RETRACTORS)
 TURNER WARWICK (SELF RETAINING RETRACTORS)
 TURNER WARWICK (HEY GROVES)
 URETHRAL STAFF (UROLOGY)
 TURNER WARWICK DISSECTING SCISSORS (UROLOGY)
 TURNER WARWICK NEEDLE HOLDER (UROLOGY)
 TURNER - WARWICK METAL DILATORS (UROLOGY)
 THOMPSON-WALKER PENILE CLAMP (UROLOGY)
 TISCHLER-MORGAN (CERVICAL BIOPSY FORCEPS)
 TOWNSEND (CERVICAL BIOPSY FORCEPS)
 TUFNOL MALLET (MALLETS)
 TRETOWAN BONE LEVER (BONE LEVERS & ELEVATORS)
 TROTTER (BONE RONGEURS)
 TUNNELING SET
 TUBBS (DILATORS)

U

UTERINE (SCISSORS)	18
UTERINE (SCISSORS)	19

V

VASCULAR SCISSORS (TC SCISSORS)	35
VACUME EXTRACTION SUCTION HEAD (UTERINE CANNULAE)	149
VOLKMANN (RASPATORIES)	159
VERBRUGGE (BONE HOLDING FORCEPS)	182

W

WATSON (SKIN GRAFTING KNIVES)	14
WOODS TONSIL (ORAL SCISSORS)	22
WHEELER TONSIL (ORAL SCISSORS)	22
WILSON TONSIL (ORAL SCISSORS)	22
WANGENSTEEN (TC DISSECTING FORCEPS)	39
WAUGH (TOOTHED DISSECTING FORCEPS)	47
WAUGH (DELICATE DISSECTING FORCEPS)	51
WEBSTER (NEEDLE HOLDERS)	72
WARD (NEEDLE HOLDERS)	75
WRIGHT (NEEDLE HOLDERS)	76
WANGENSTEEN (NEEDLE HOLDERS)	77
WEBSTER (TC NEEDLE HOLDERS)	87
WATSON CHEYNE (DISSECTORS)	90
WALACE MODIFIED (SELF RETAINING RETRACTORS)	95
WEISLANDER (SELF RETAINING RETRACTORS)	100
WERTHEIM (HAND HELD RETRACTORS)	107
WALTON RECTAL (SIGMOIDOSCOPY / BIOSPY)	142
WRIGLEY (OBSTETRICS INSTRUMENTS)	148
WITTNER (CERVICAL BIOPSY FORCEPS)	151
WILLIGER (BONE LEVERS)	162
WILMS (BONE RONGEURS)	179
WEBER (ATRAUMA CARDIOVASCULAR FORCEPS)	191

Y

YEOWMAN BIOPSY FORCEPS (PROCTOLOGY HAEMORRHOIDAL LGATORS)	141
---	-----

Z

ZWEIFEL (TC NEEDLE HOLDERS)	84
ZOELLNER DETACHABLE ENDS (SUCTION TUBES)	168

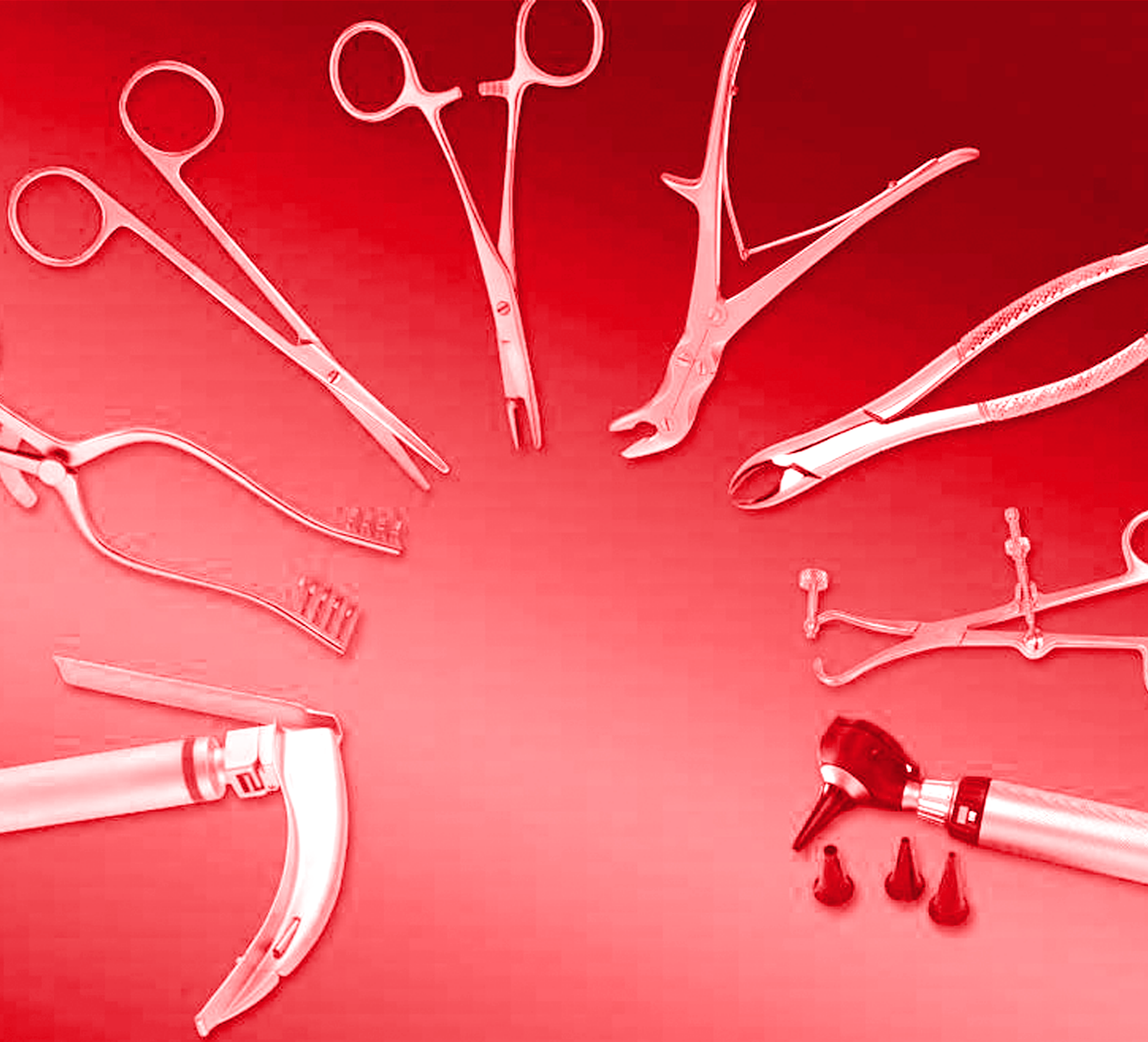

GLOMED INSTRUMENTS

Grosvenor Business Tower, 1503, TECOM, Dubai, UAE.
PO Box 283024, T: +971 4 435 7344, F: +971 4 435 7345

gmed-instruments.com